

# The Coop + Run



assembly manual

**coop**

Hey Farmer!

We're so excited for you to experience Smart Coop magic in your backyard. This manual will guide you through the assembly of the coop and run step by step. We've worked hard to make assembly easy for anyone, so no need to get your feathers in a ruffle.

To get started, unpack all boxes, lay out their contents and review the parts to familiarize yourself with each piece, screw and gasket. Separate the metal parts from the plastic ones. Begin the assembly with the metal chicken run, then proceed with the coop assembly on top of it.

A few important notes before you get started:

- **Camera connectivity is a crucial part of your Smart Coop experience. Please make sure you test your home WiFi in the spot where you'd like your coop in your backyard before starting assembly. We suggest downloading the Coop App and pairing your cameras beforehand just to be double-sure.**
- **The Run structure is predator-tough and heavy, so we recommend grabbing a buddy and setting aside about two hours.**
- **We have assembly videos for every step, make sure you give those a quick watch.**

**NOTE! All directional instructions are based on the perspective of facing the small chicken door, both in the coop and run**

**Please watch our handy assembly video guides before proceeding!**

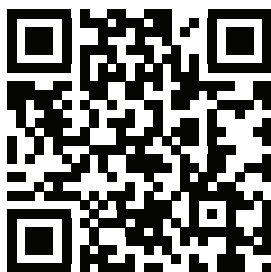

Run

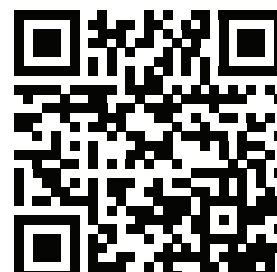

Coop



**WARNING:** Panels are not expected to balance on their own before they are screwed together. Make sure the assembly spot you defined is not accessible by children or small pets. In case a panel falls before it gets connected to other panels, it may cause serious or fatal injuries.



# before you begin...where should you position your coop?

To keep chickens comfortable, be sure to place your coop in an area with partial shade and partial sun.

If you plan to keep coop under the direct sunlight, follow these simple steps:

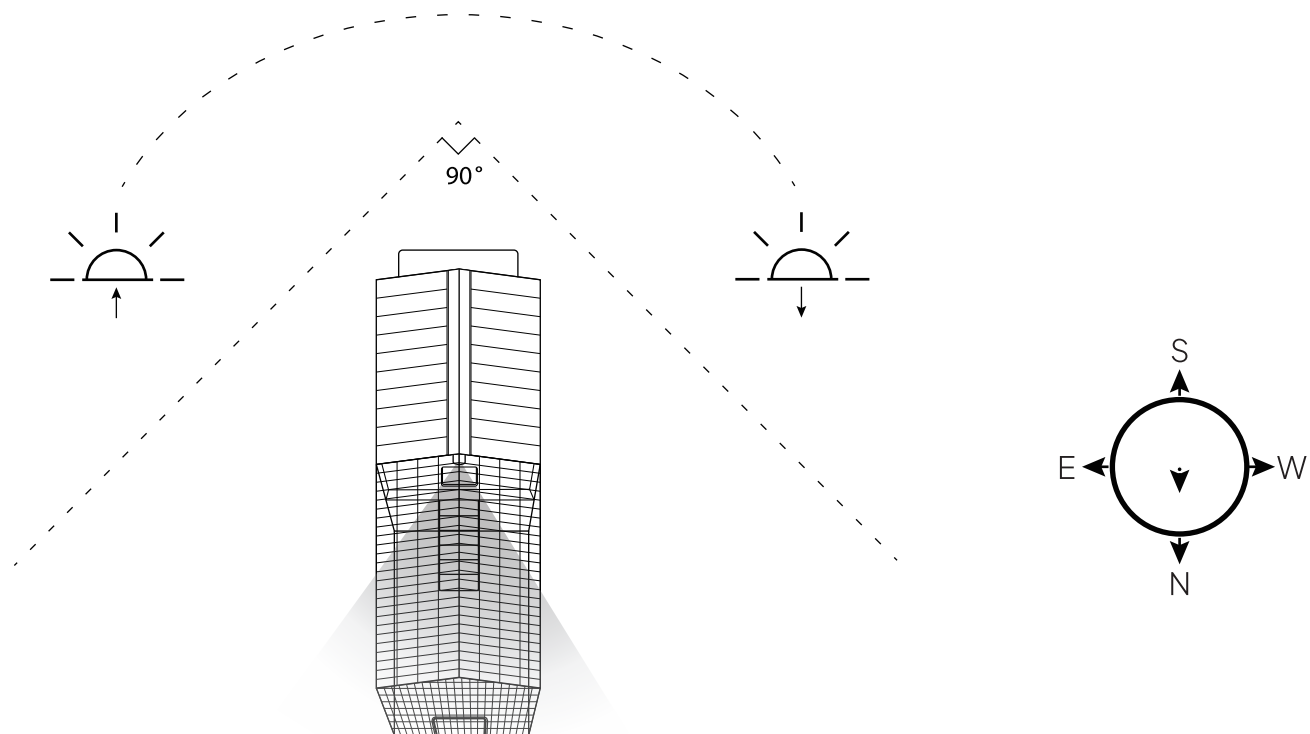

- Determine the sunrise and sunset points in your backyard
- Position your chicken coop with the nesting box facing south during midday, and the exterior camera facing north.
- The 90-degree angle between the northwest and northeast corners of your yard is the most desirable position. This doesn't need to be an exact science, but generally close.

Adhering to these guidelines will keep your coop in optimal working condition year-round:

- Increased shade for chickens during daytime
- Improved visibility on sunny days
- Extended camera battery life due to prevention of overheating
- Enhanced performance of your automatic chicken door from direct sunlight on the rear window.

# contents

Diagrams of Parts.....	5
Run Assembly Instructions.....	8
Coop Assembly Guide.....	19
Automatic Chicken Door Activation .....	34
CoopCam Installation.....	35
Additional Camera & Door Operating Guides.....	36
FAQ.....	46

# Diagram of Parts



# Run

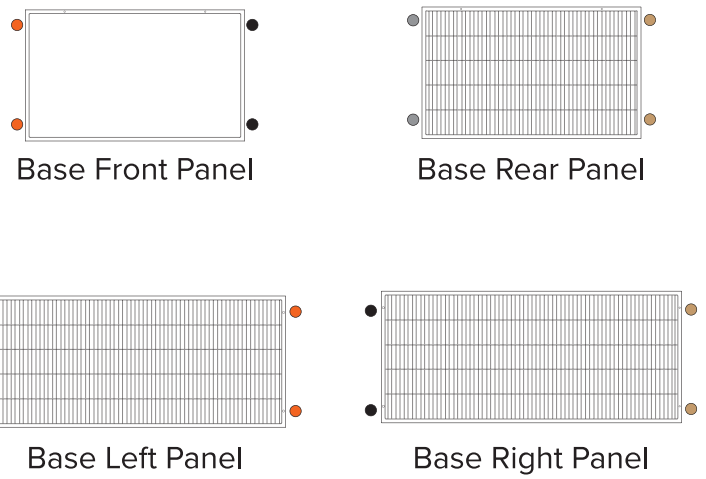
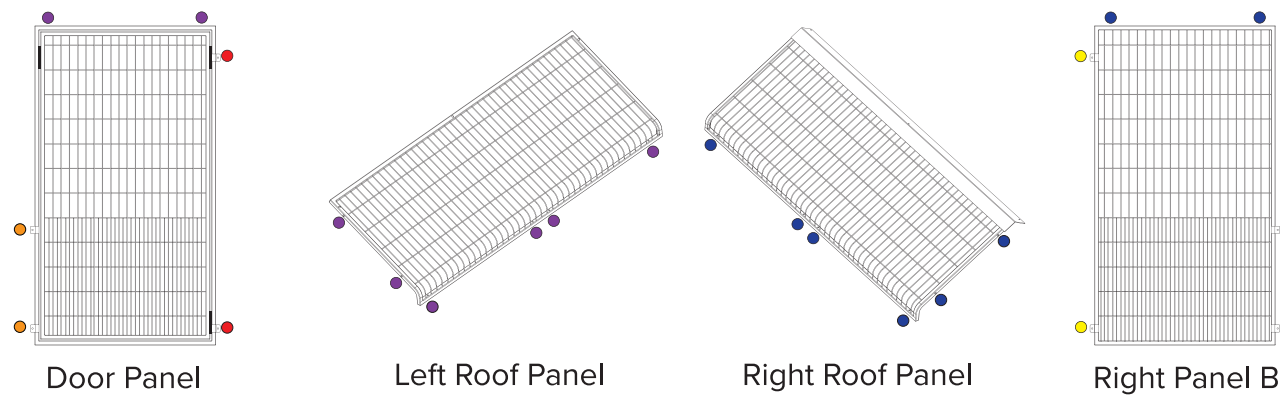
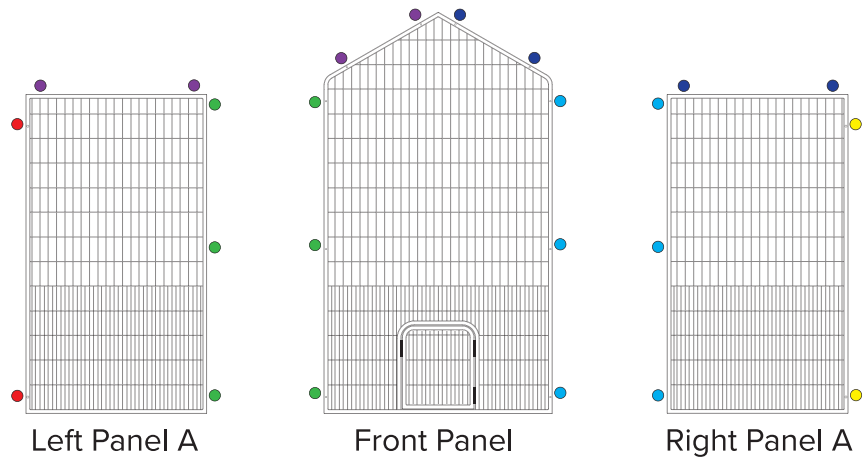

**actual size**



x33 gaskets



x26 long screws



x7 short screws

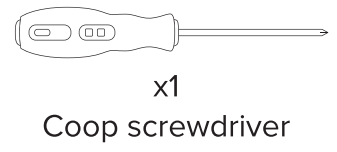

# Coop



Floor Panel



Right Wall



Left Wall with Doors

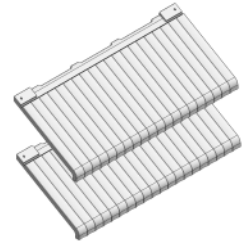

Two Roof Panels



Front Panel with Chicken Door

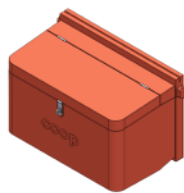

Nesting Box

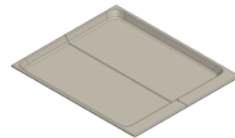

Compostable Litter Tray



Chicken Ladder



Front Window with Camera Mount pre-installed



Rear Window with Camera Mount pre-installed



Roof Cap



Two Roosting Bars

## actual size



x10

1-1/2" silver screws



x4

1-1/2" black screws



x4

3/4" silver screws



x1

1" thumb screw

# Run Assembly



A few important notes before you get started:

- When assembling the Run, use our handy sticker system for assembling parts in the correct place, matching colored dots together. free to remove them altogether.
- Make sure you're assembling on even ground, for ease and for chicken-safety!
- Please use the provided plastic gaskets on **all screws** when assembling the Run except for screws to mount strike plates for spring latches. These will protect the coating and prevent scratches.

Let's get going! One small step for you, one giant leap for hen-kind!



# step #1

## what you need

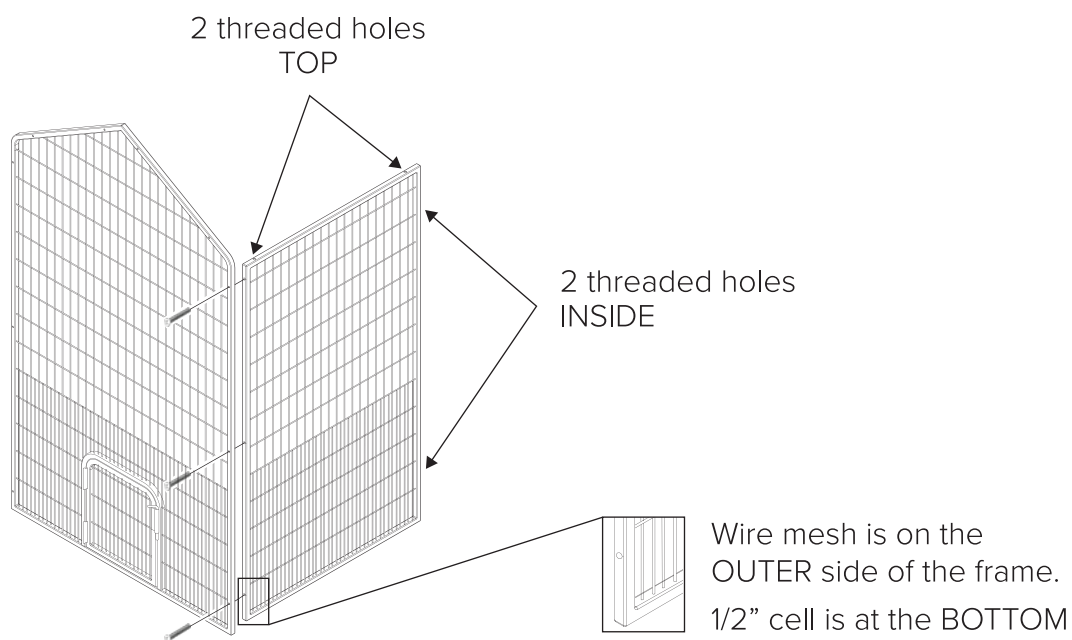
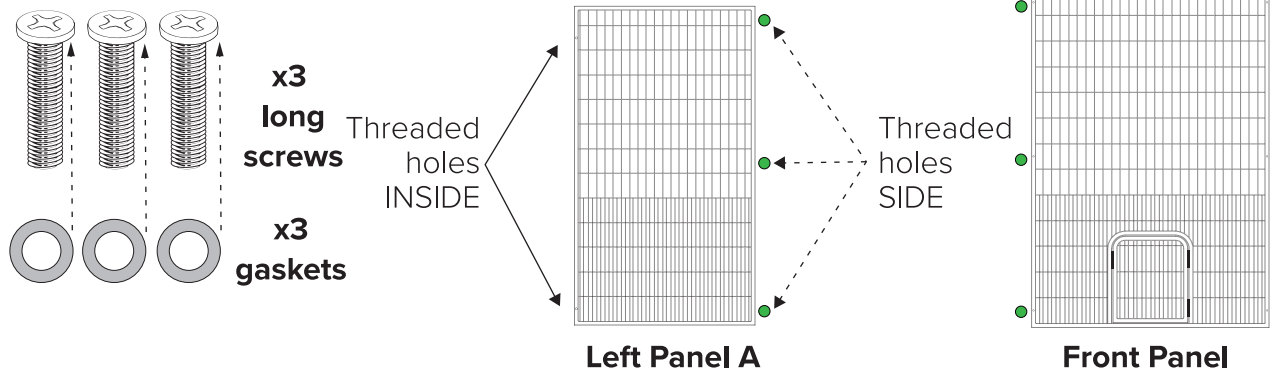

Find the **Front Panel**, the tallest section of the Run with a small hinged door at the bottom. Now, find **Left Panel A**, marked with **green dots**. Raise **Left Panel A** and the **Front Panel** to form a 90-degree angle, matching the green dots together. Double-check the section of the Run with a smaller rectangle pattern is closest to the ground, and the small hinged door opens outward.

Locate three holes along the edge where the **Front Panel** and **Left Panel A** connect. Attach using your screwdriver and three long screws. (Make sure the plastic gasket is slid all the way up on each screw for your Run assembly moving forward. We won't remind you again, but please make sure!) Avoid over-tightening for now, we'll tighten them firmly at the end.

## step #2

### what you need

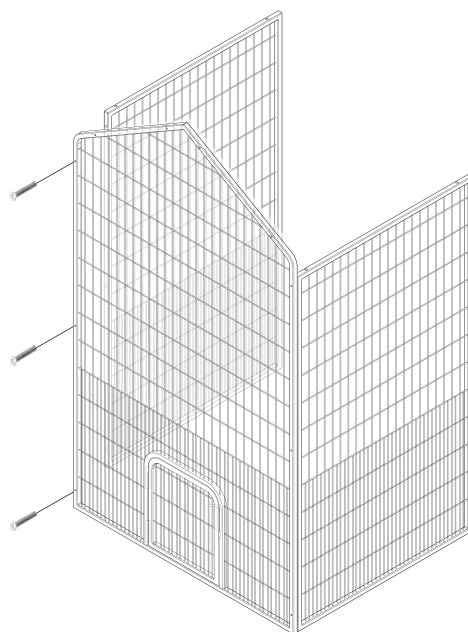
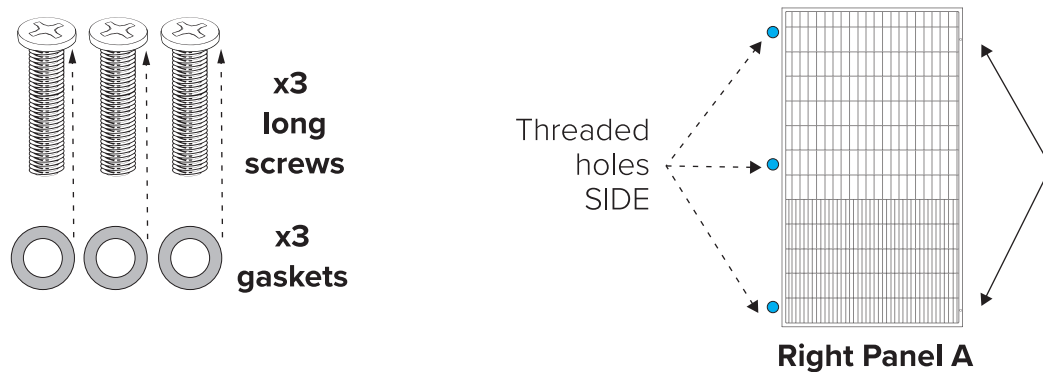

Locate **Right Panel A** with blue dots, and raise to meet the Front Panel just like we did in step 1, matching **blue dot** to **blue dot**. Ensure the tighter mesh pattern is closest to the ground. Locate three holes along the edge where the **Front Panel** and **Right Panel A** connect. Attach using your screwdriver and three long screws. No over-tightening!

## step #3

### what you need

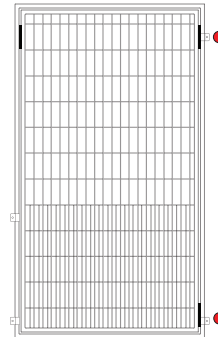
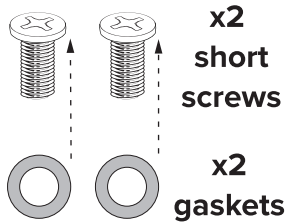

Door Panel

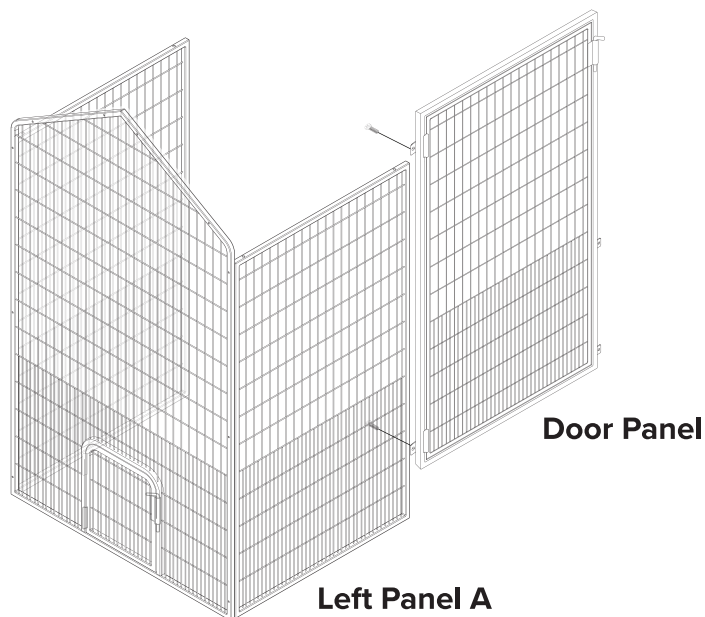

Locate the panel with two **red stickers** and a pre-installed door with hinges. This is the **Door Panel**. Match the **red dot** to **red dot** and attach the **Door Panel** to **Left Panel A**. Screw in from the inside using two short screws. Ensure the door opens outward.



# step #4

## what you need

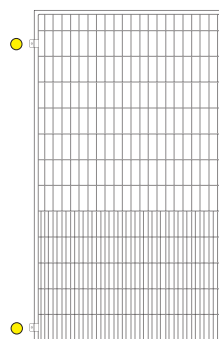
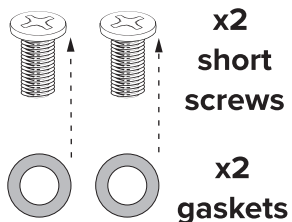

Right Panel B

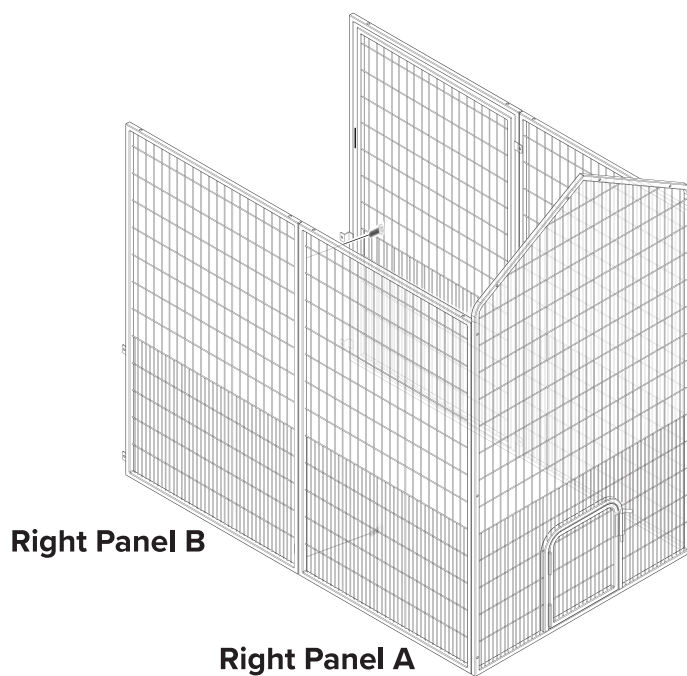

Locate the panel with flanges on both edges, and two yellow stickers. This is **Right Panel B**. Matching **yellow dot** to **yellow dot**, connect **Right Panel B** to **Right Panel A**. Screw in from the inside using two short screws.

# step #5

## what you need

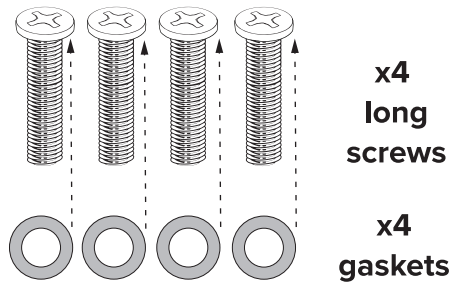

Through holes  
for coop mounting



**Base Front Panel**

Note: the Base Front Panel has two through-holes and one threaded hole on top for the ladder.

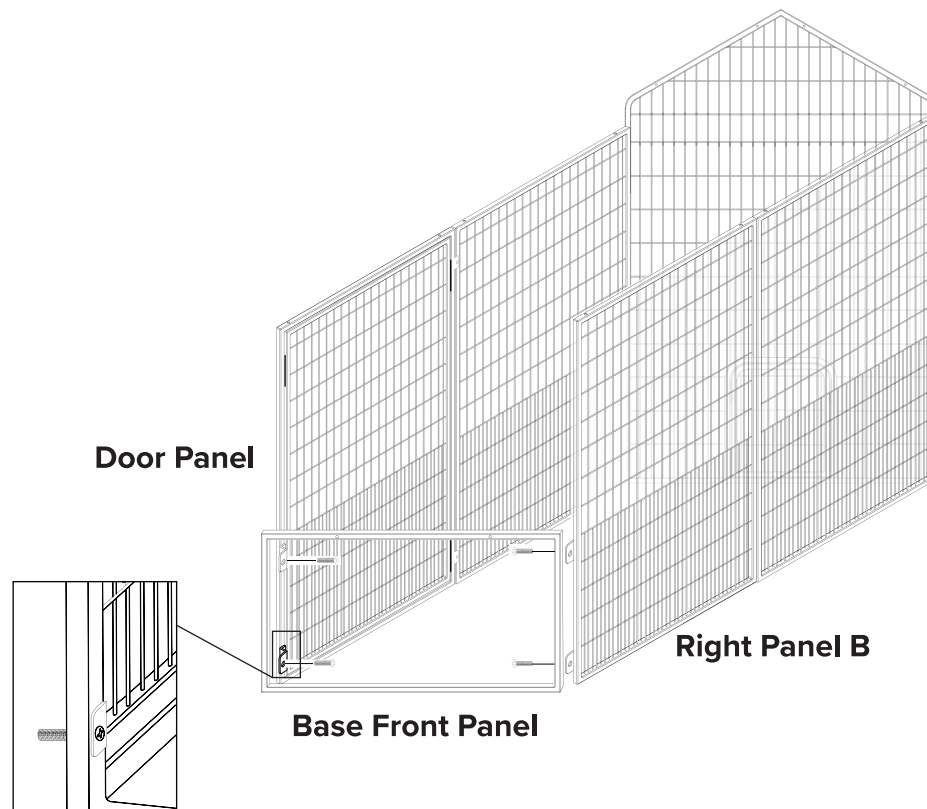

Find the **Base Front Panel**, the section without any mesh fencing. Ensure the side with one threaded hole is furthest from the ground.

Match **orange dots (left)** and **black dots (right)** together. Slide the base panel in, nesting it between the flanges. Attach from the inside, using two long screws on each side.

## step #6

### what you need

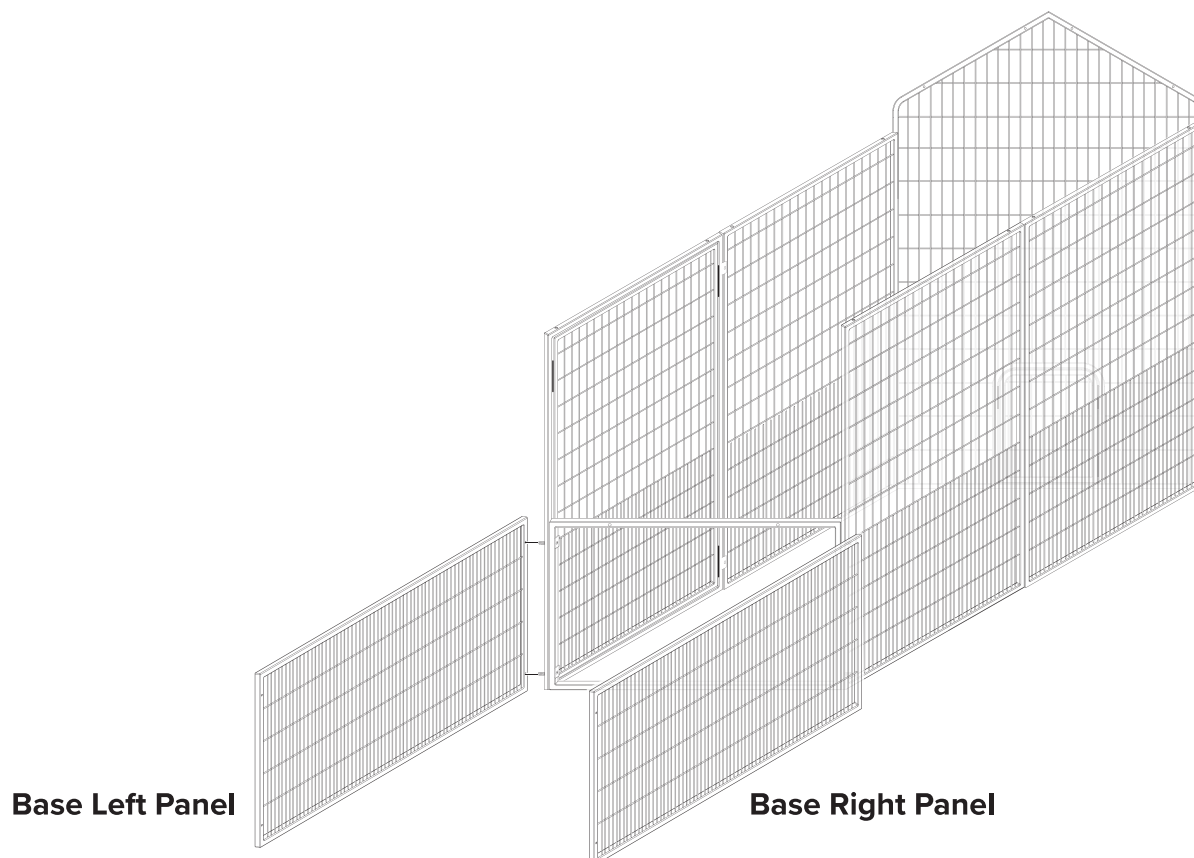
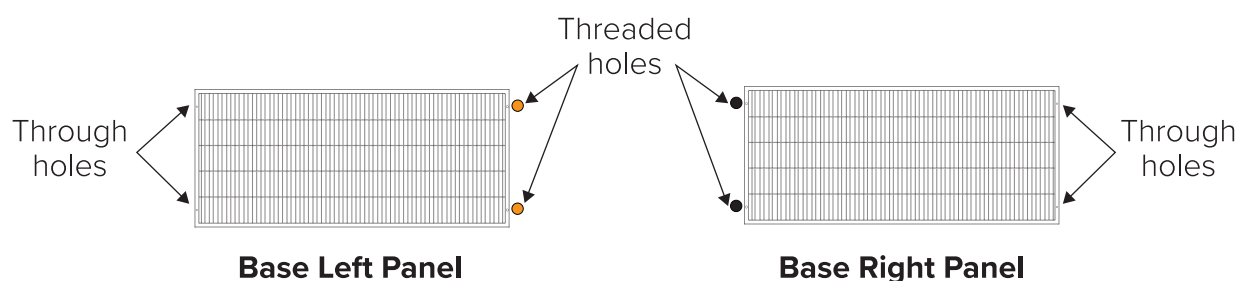

Locate the **Base Left Panel** and align it with the **orange dots** and flanges from the previous step. Connect the panels by screwing two long screws through the flanges.

Find the **Base Right Panel** and repeat, aligning it with the **black dots** from the previous step. Connect by screwing two long screws through the flanges, ensuring the mesh pattern is on the outside. (This may be hard to distinguish at first glance, but just make sure the fencing pattern feels like it's closest to the exterior of the coop.)



# step #7

## what you need

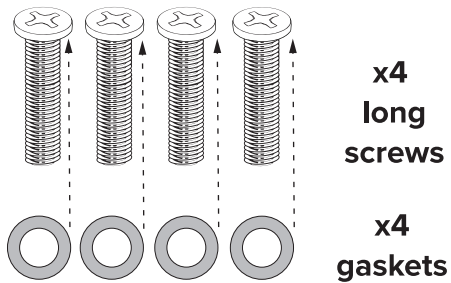

Through holes for coop mounting

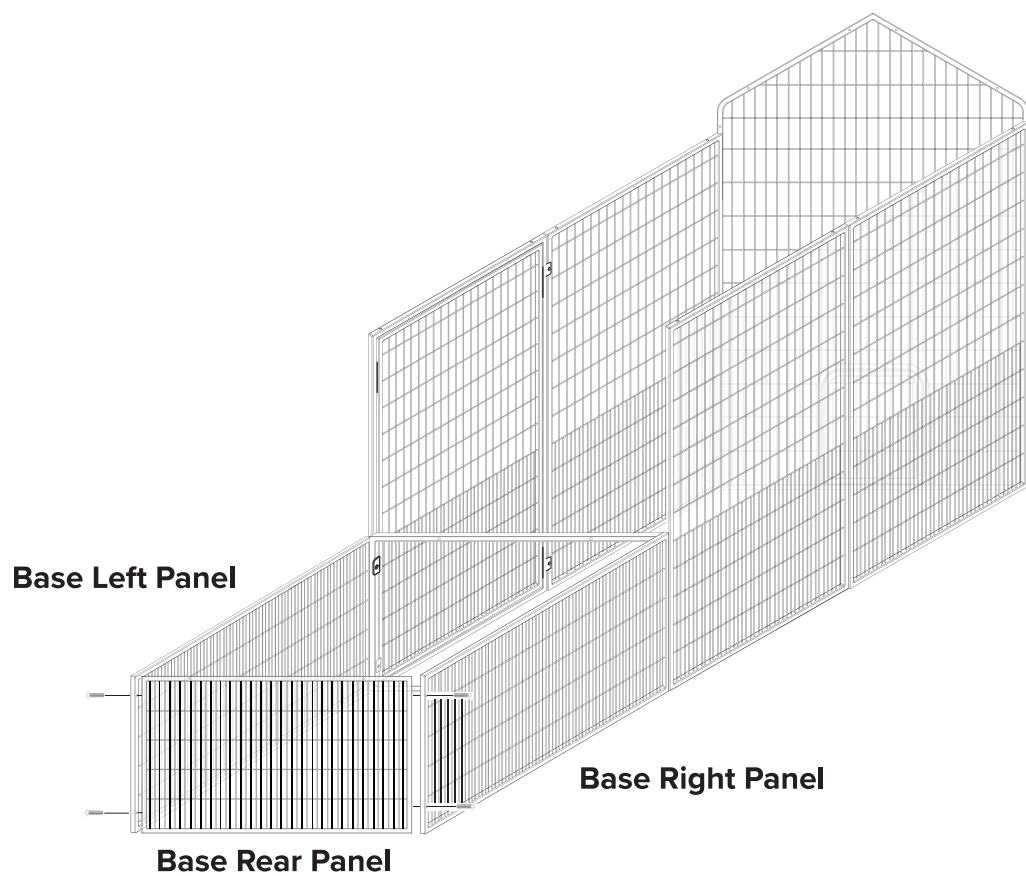
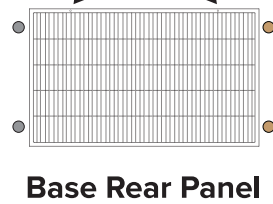

Locate the **Base Rear Panel**. Align the **silver dots** on the left side and **gold dots** on the right side. This will enclose the structure, forming a rectangle. Use four long screws to tighten securely.

# step #8

## what you need

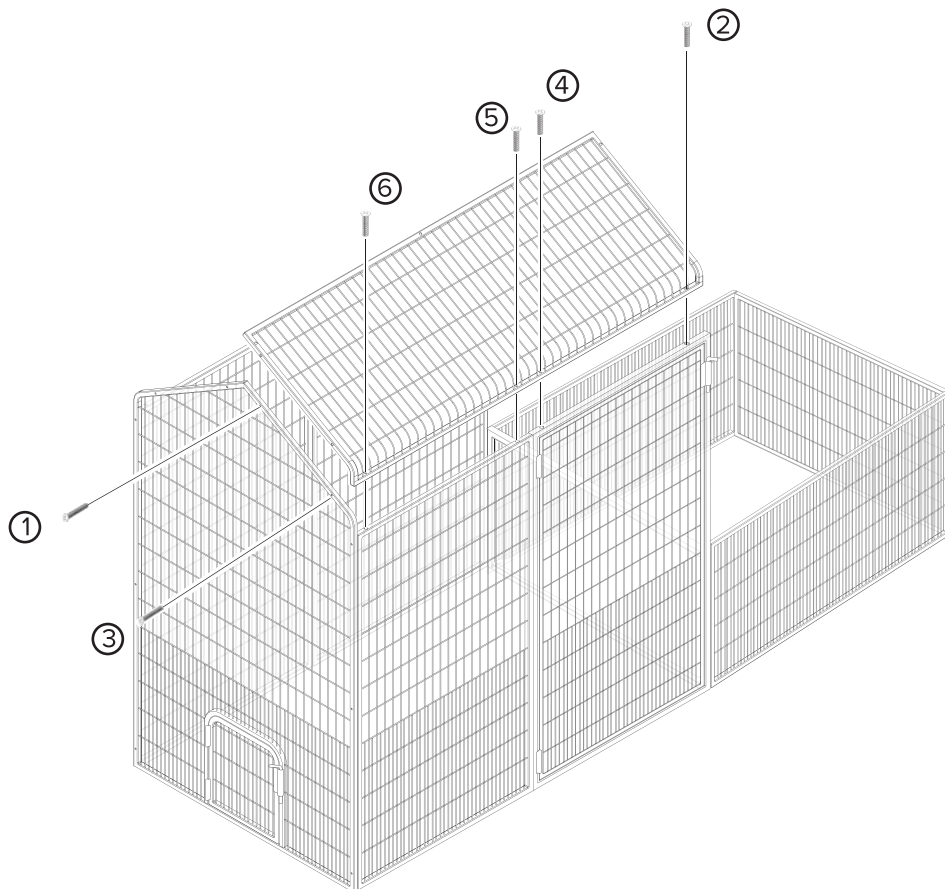
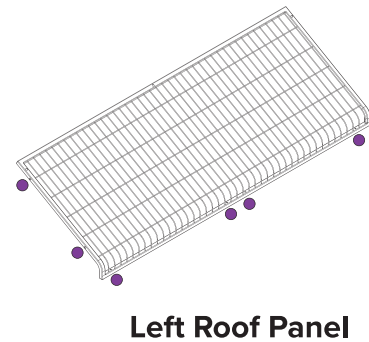
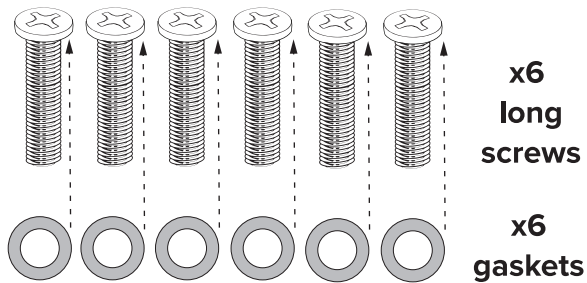

The **Left Roof Panel** is the roof section without the attached cap.

Align the **purple dots**, placing it on top of the structure. (Double-check this panel is on the same side as the panel with the swinging door.) Start by screwing one long screw horizontally on the front side. Next, insert one long screw vertically near the spring latch. Screw in the remaining four long screws according to the diagram to secure the roof panel.

## step #9

### what you need

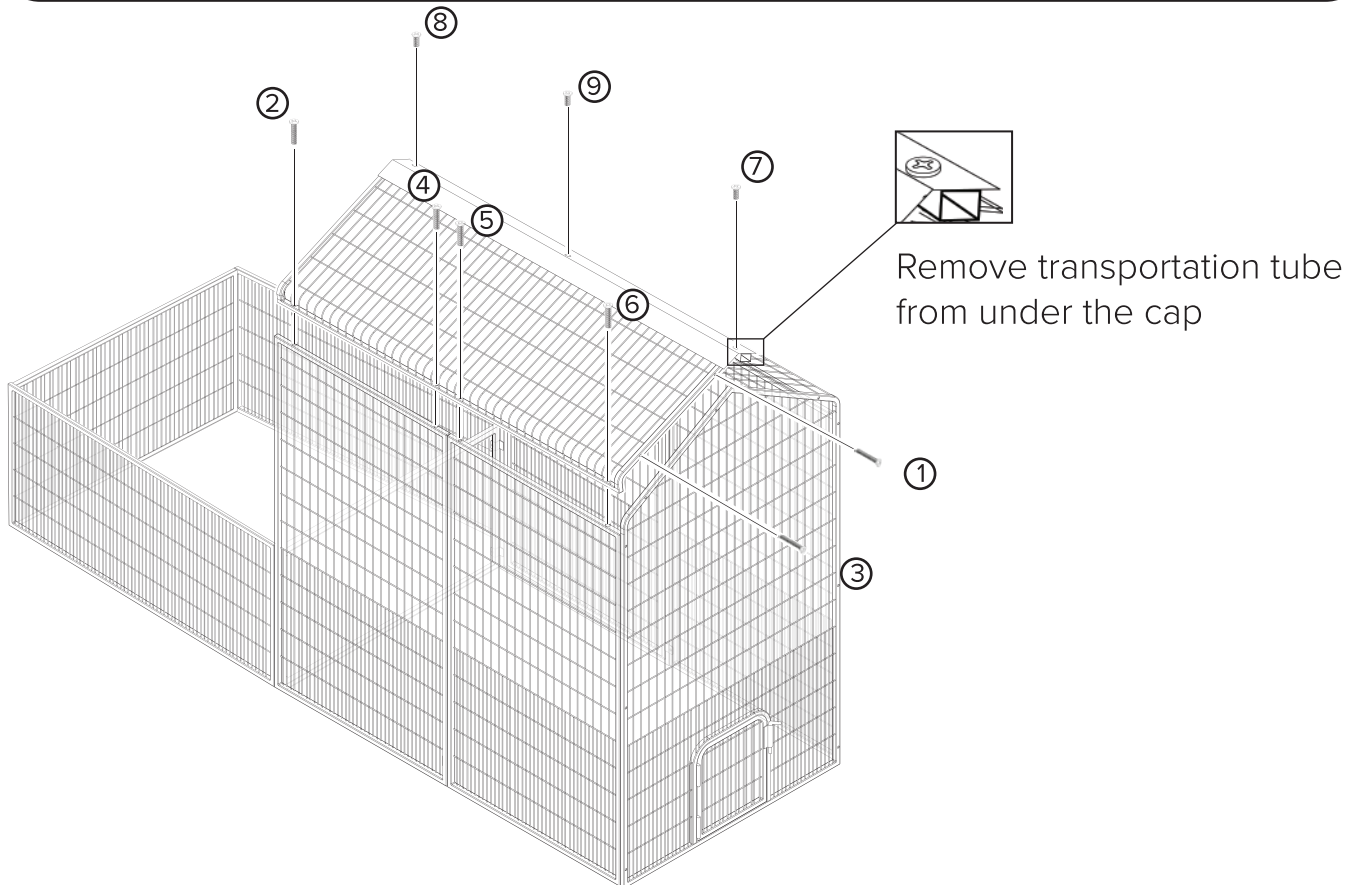
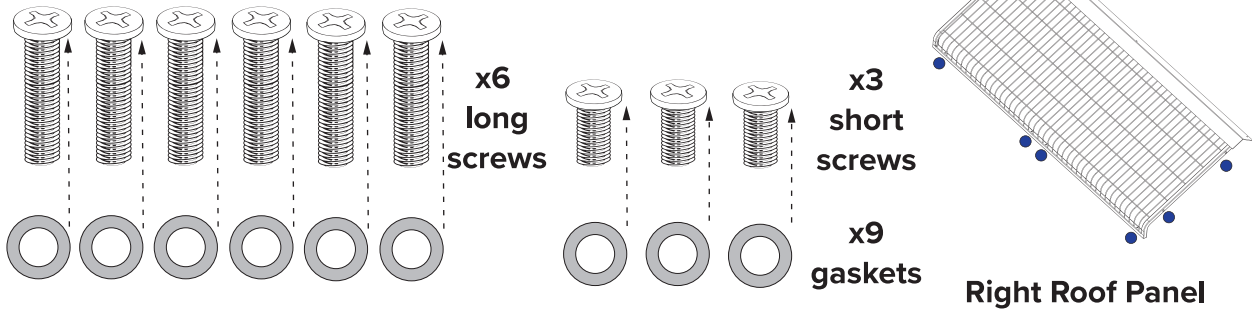

Locate the **Right Roof Panel**, the remaining roof section with an attached cap. There is an extra metal tube under the cap to protect the roof during transit, mounted with two screws. Please unscrew to remove and discard.

Place the panel on top to complete the roof structure, aligning **navy dot** to **navy dot**. Insert two long screws horizontally from the side of the **Front Panel** and the remaining four long screws vertically along the bottom perimeter of the roof. Finish by inserting three short screws along the pitch of the roof cap.

**Now, fully tighten all screws to secure your Run going from top down!**



# Coop Assembly

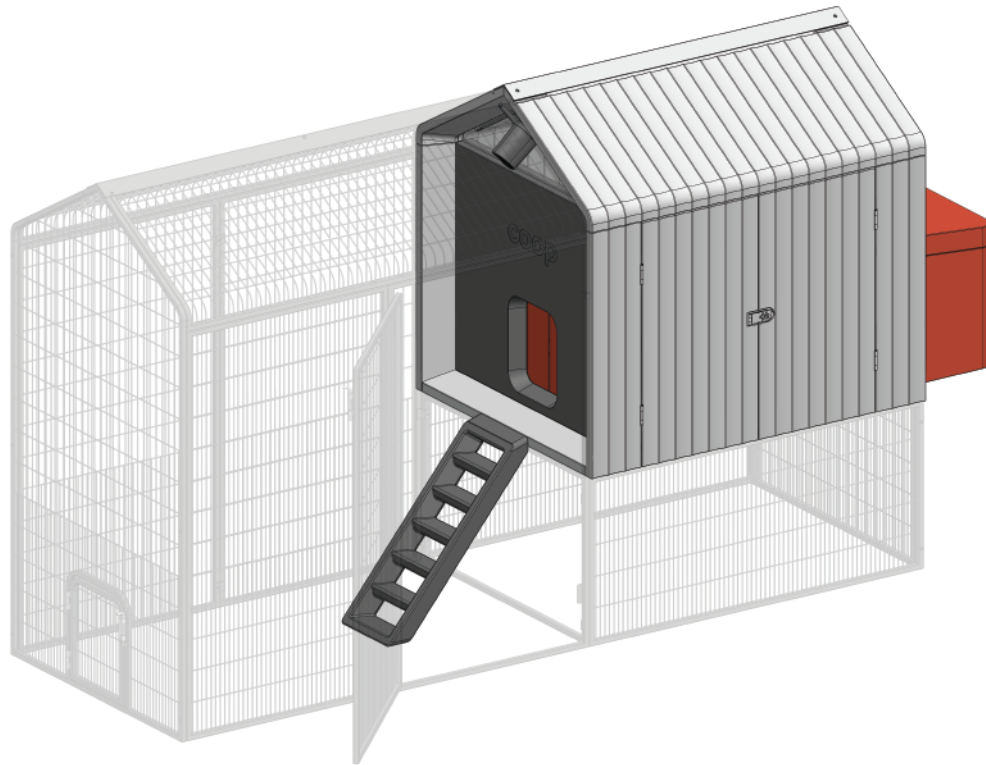

A few important notes before you get started:

- Some customers choose to speed up the assembly process by using an electric screwdriver or drill, and we recommend this for efficiency. However, you can also assemble the coop using the provided screwdriver.
- If you decide to use a drill, it's important to exercise caution and apply lower torque to prevent any damage like stripping plastic.
- Here's a pro tip: during your initial drive for each screw, leave about 1/2" of space. Then, toggle your drill and gently reverse the screw out by about 1" to ensure the panels are aligning correctly. Once they're snugly aligned, go ahead and fully drive in the screw. When done correctly, there should be no gaps or spaces between the parts.

Now let's get this high-tech hen haven assembled!

# step #1

## what you need



x4  
1-1/2" Black Screws



Floor Panel

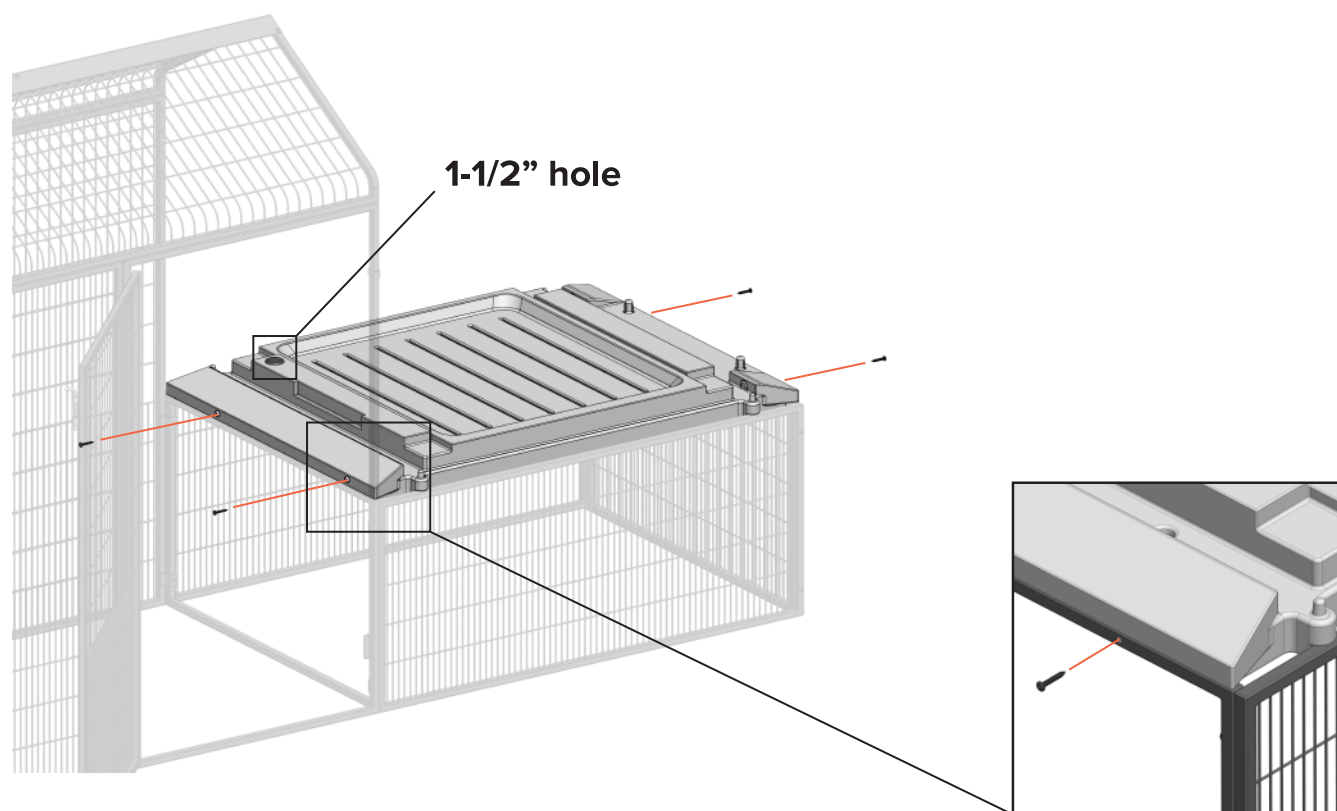

- Place the Floor Panel on the metal support frame with the flat surface facing down, making sure the 1-1/2" hole is facing up and closest to the front of the Coop. (Note: we included this extra hole for an electrical cable in case you want to add additional elements to your coop. We do recommend keeping this hole open during the summer time for increased ventilation.)
- Insert the four black 1-1/2" screws via the through-holes in the metal frame (two on each side) and tighten using the screwdriver.

**Avoid over-tightening the screws. Once you feel the resistance from the metal frame, an additional half turn is sufficient.**

## step #2

### what you need

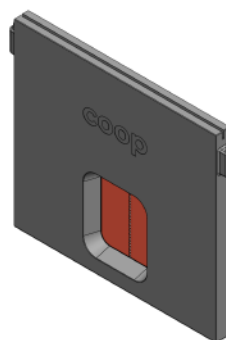

**Front Panel**  
with pre-installed Chicken Door

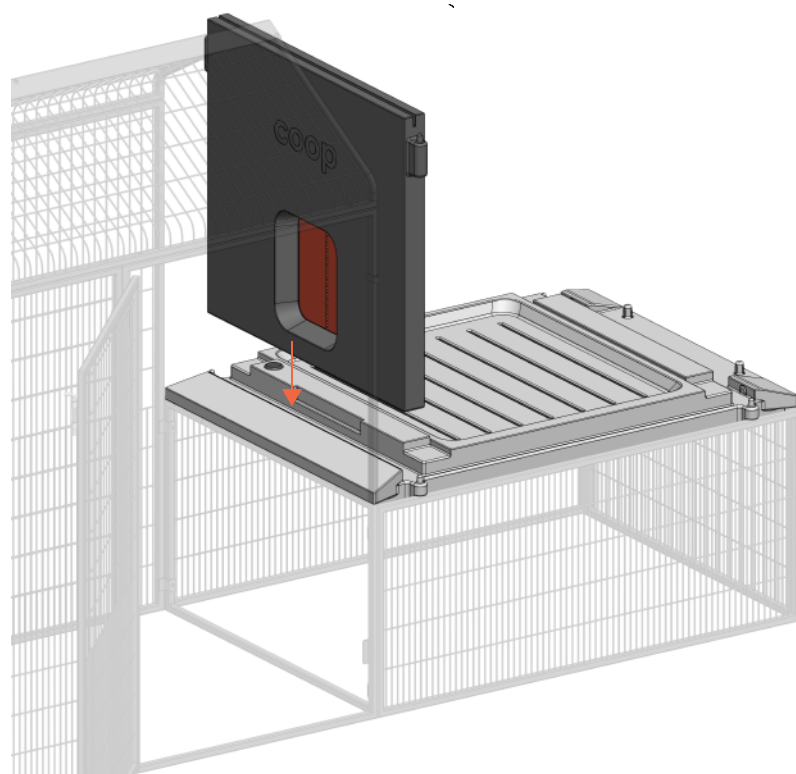

- Slide in the Front Panel from the top, ensuring that the automated chicken door black control block faces the inside of the Coop.



## step #3

### what you need

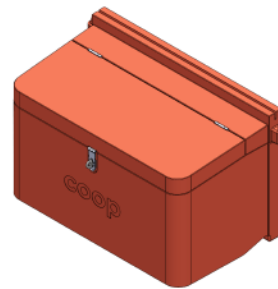

Nesting Box

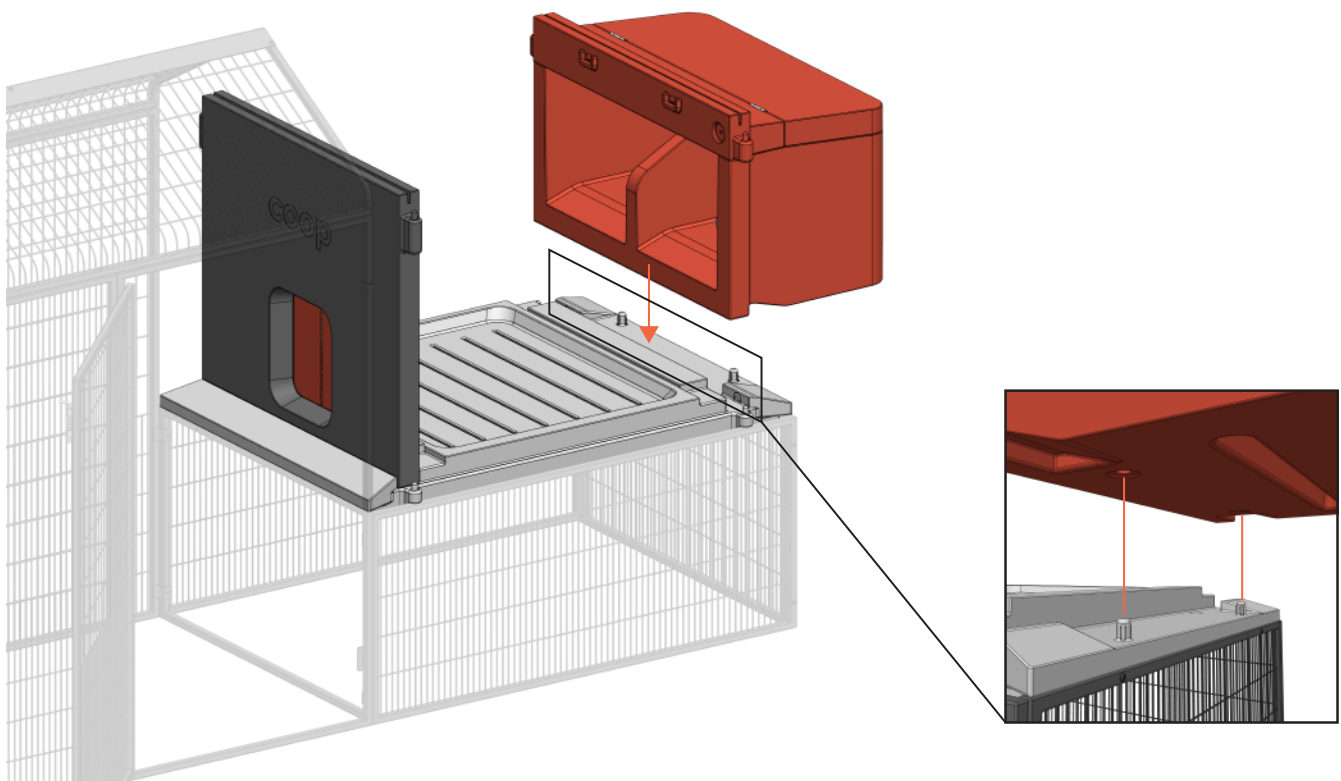

- Slide in the Nesting Box from the top.
- Match the pegs from the Base Panel with the recesses on the Nesting Box.
- Ensure a snug fit between the Nesting Box and Floor Panel.

## step #4

### what you need



Right Wall Panel

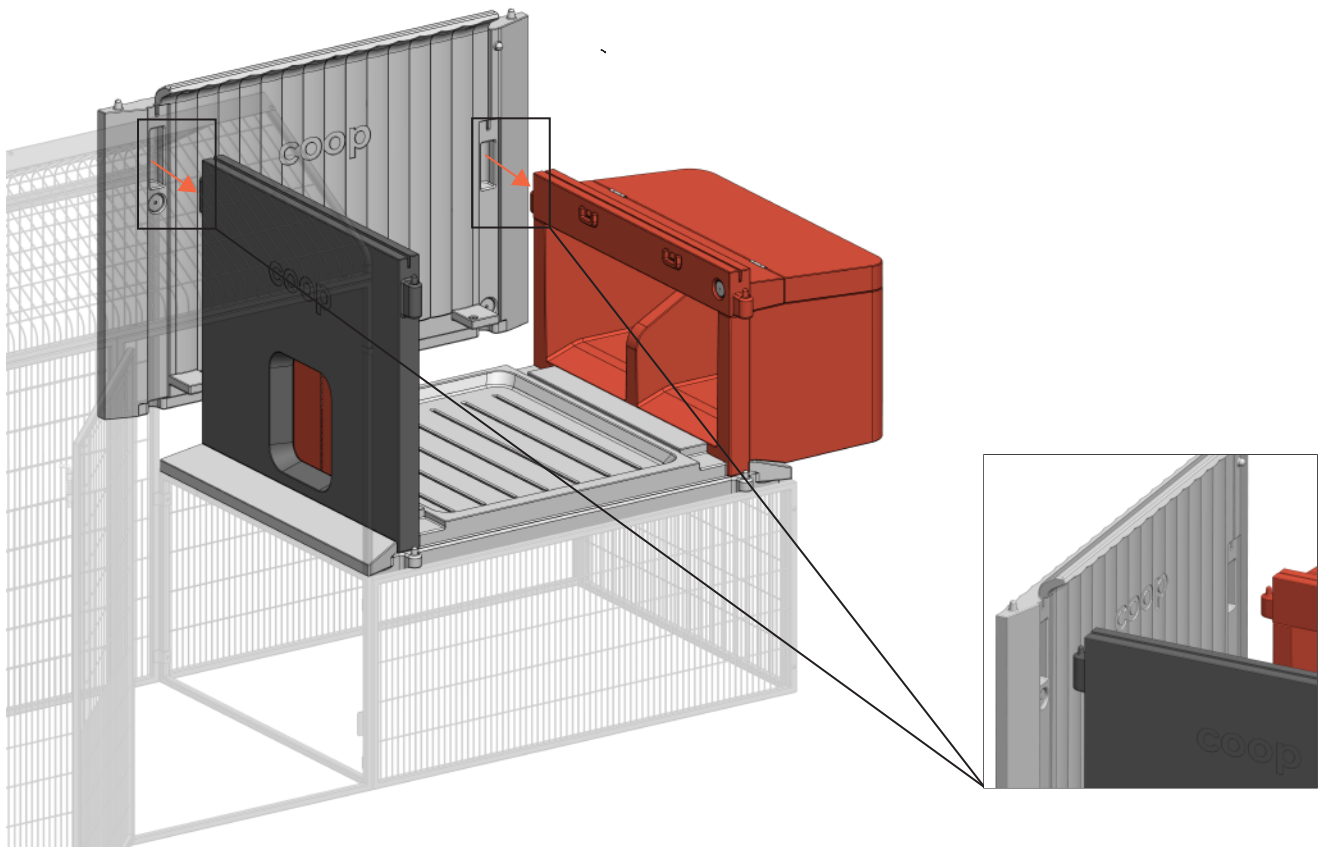

- Attach the Right Wall Panel on the side opposite of the human door with the coop logo facing inside, sliding in front the top.
- Match the pegs on the Front Wall and Nesting Box with the recesses and press down firmly.

## step #5

### what you need

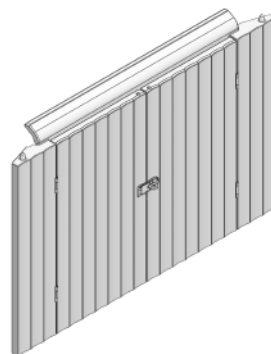

Left Wall Panel

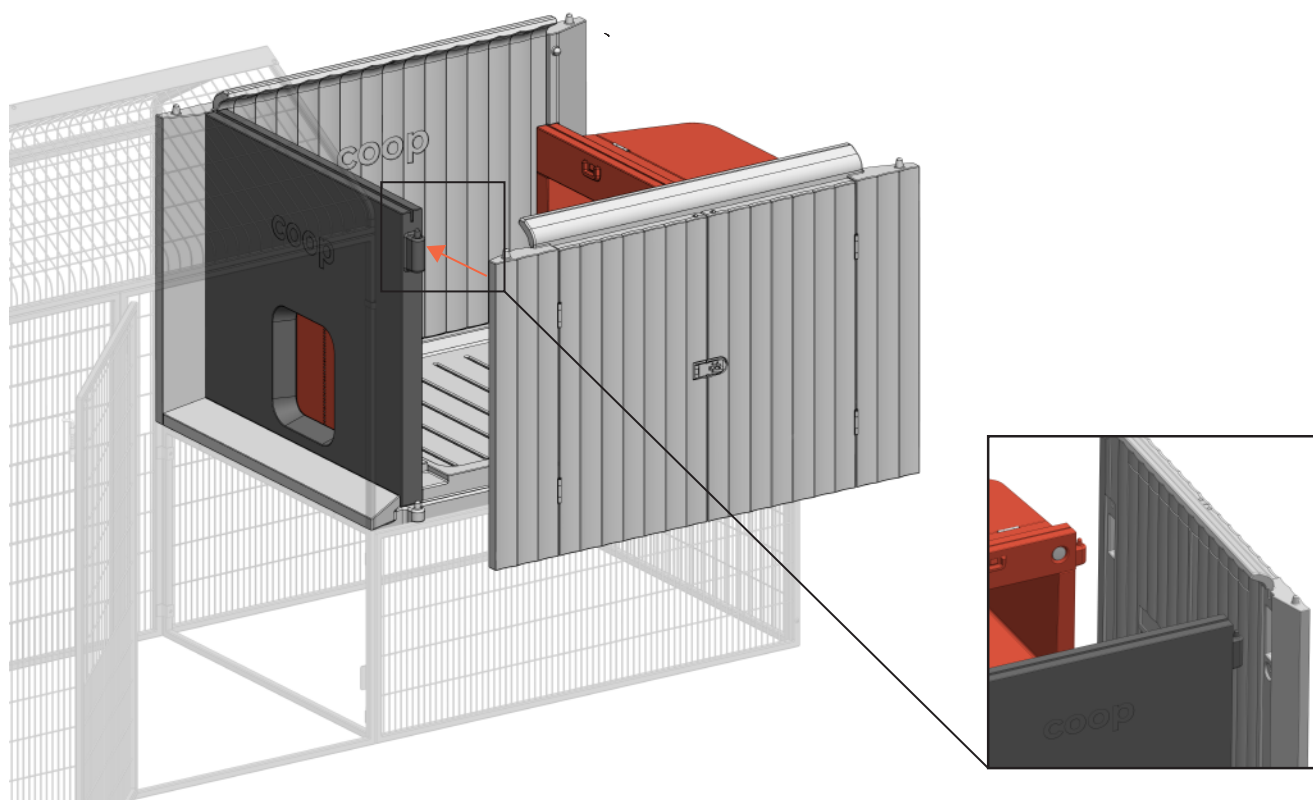

- Install the Left Wall Panel in the same manner as the previous step.
- Ensure the pre-installed swing doors open outwards.
- Ensure the panel feels secure and aligns properly with the surrounding panels.

## step #6

### what you need



x4

1-1/2" Silver Screws

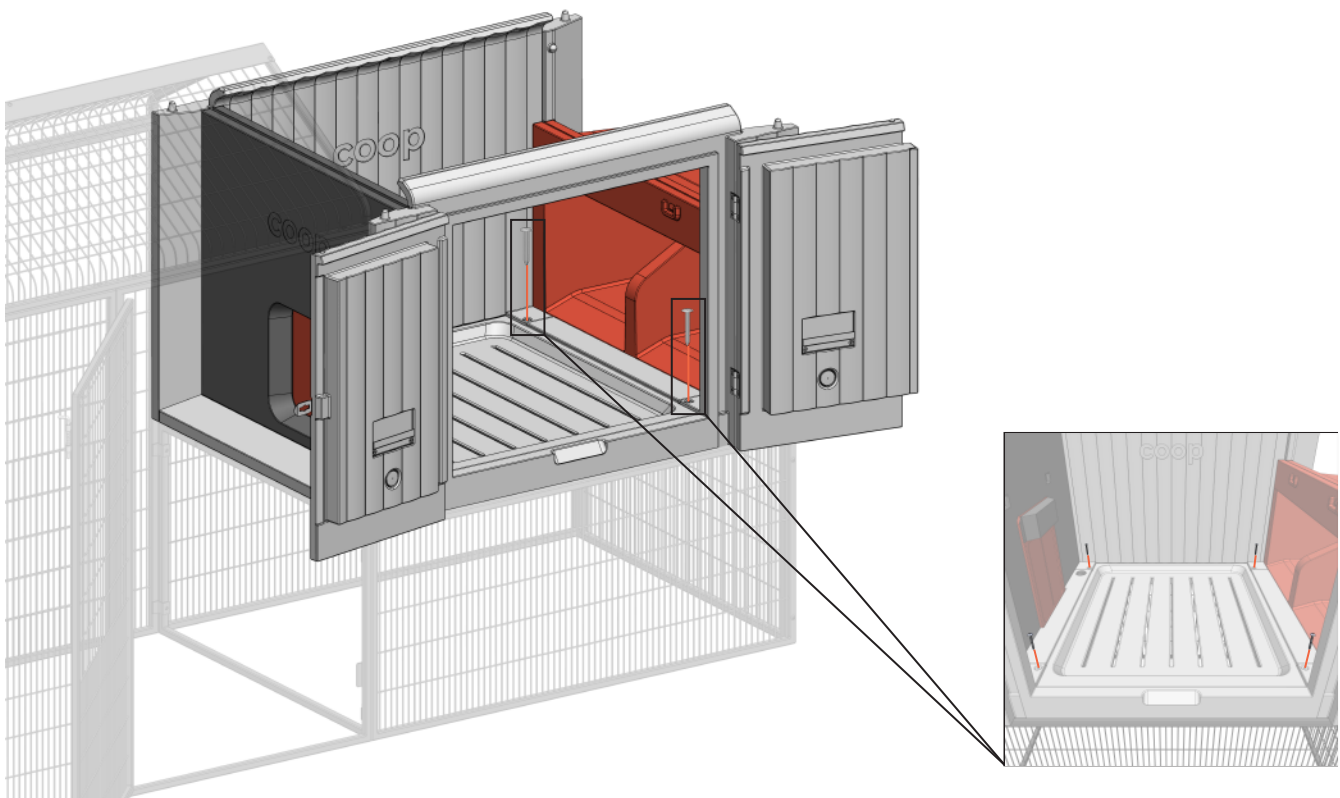

- Insert four 1-1/2" long silver screws into the circle marker in each corner of the Coop.
- Tighten the screws firmly, ensuring the Wall Panels are securely fastened with the Floor Panel.

## step #7

### what you need



Front Window

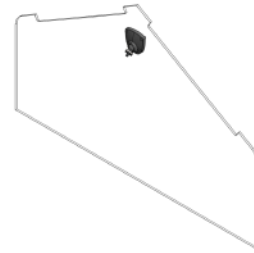

Rear Window

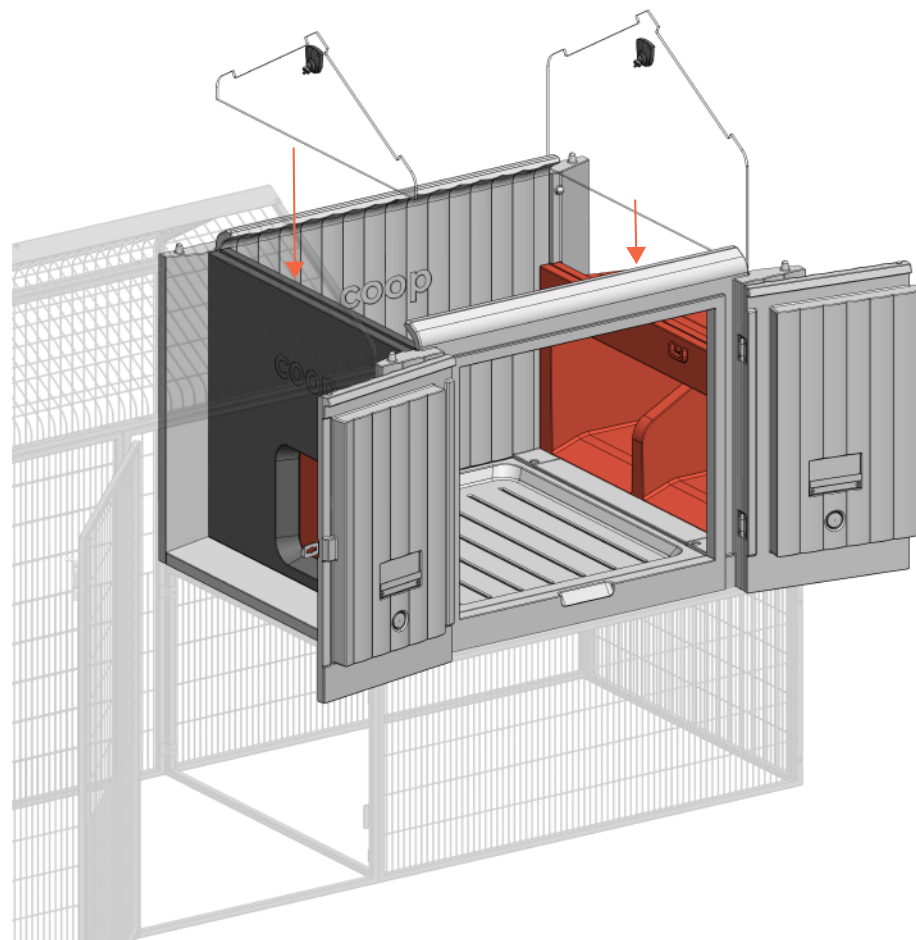

- Install the smaller Front Window by sliding it vertically into the recessed slot on the Front Panel. **Ensure that the camera mount is facing out.**
- Insert the Rear Window by sliding it vertically from the top into the recessed slot on the Nesting Box. **Ensure that the camera mount faces the interior of the Coop.**

## step #8

### what you need

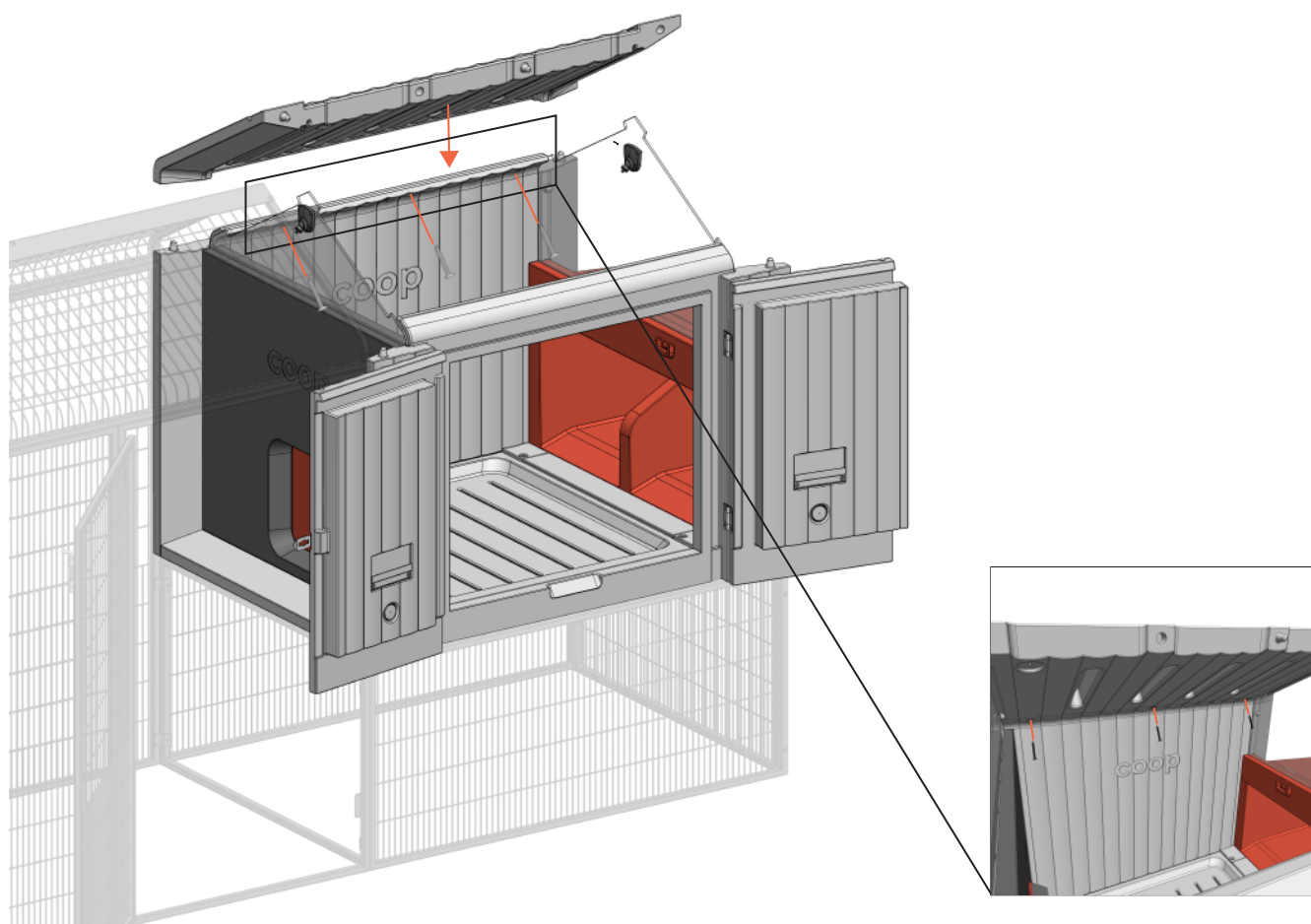
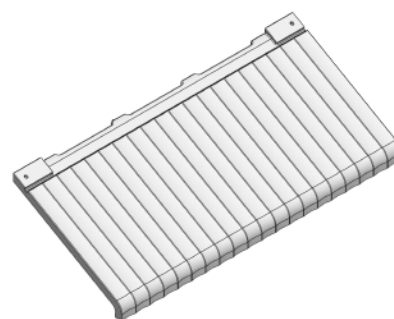

**Note: The Roof Panels are identical. It does not matter which Panel goes on which side.**

- Place one Roof Panel onto the top of the Coop, ensuring the windows slide into the recessed slots.
- Hold the Roof Panel in place with your assembly partner applying pressure from the top outside the Coop, and secure with three 1-1/2" long silver screws from the inside.

## step #9

### what you need



x3

1-1/2" Silver Screws

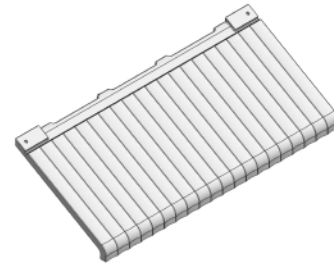

Right Roof Panel

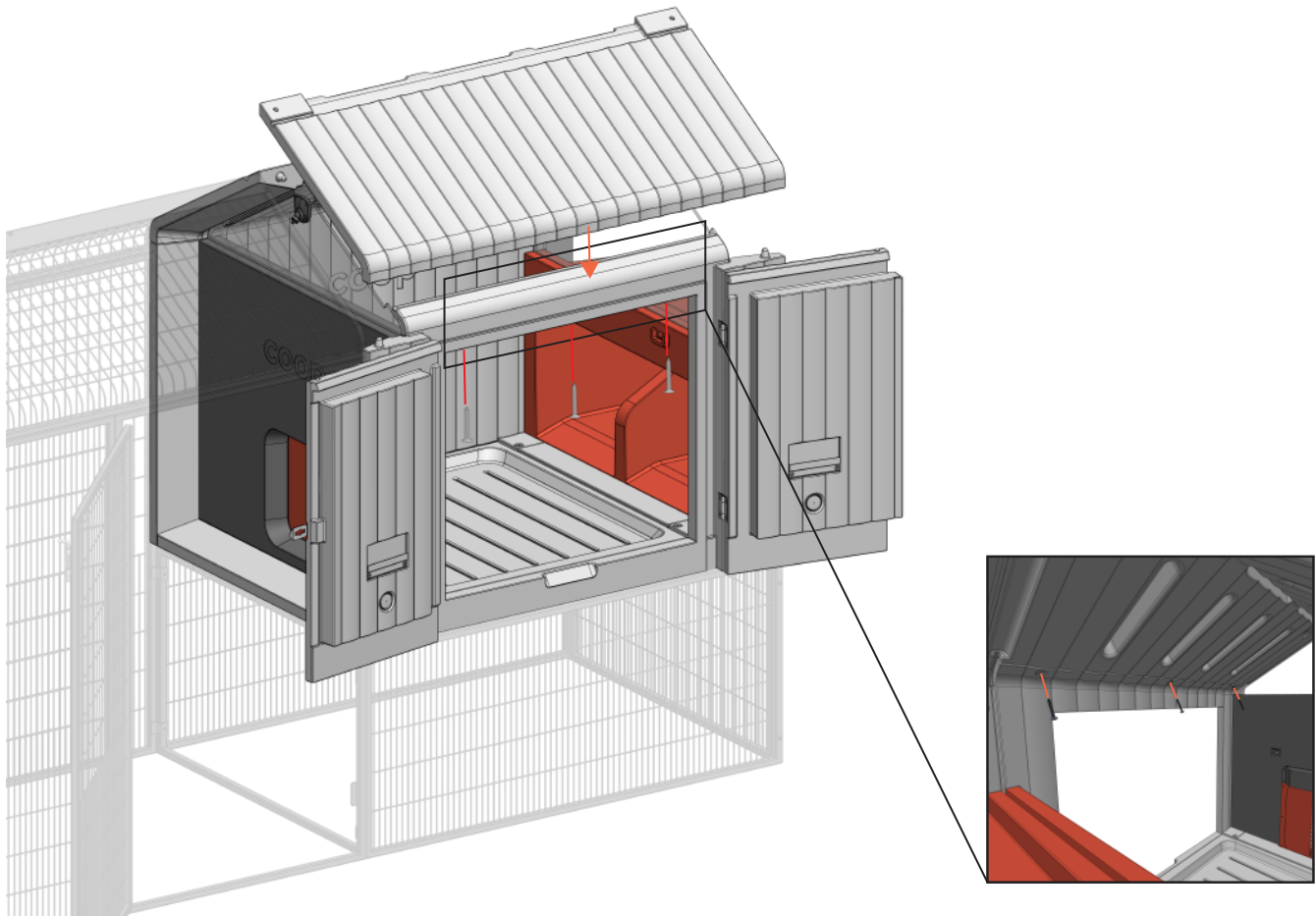

- Place the second Roof Panel on top of the Coop, ensuring the windows slide into the recessed slots.
- Slightly lift the top section of the Right Roof Panel and slide pegs into recesses.
- Insert three 1-1/2" long silver screws to connect.
- Ensure all screws are tightened securely.



## step #10

### what you need



Roof Cap

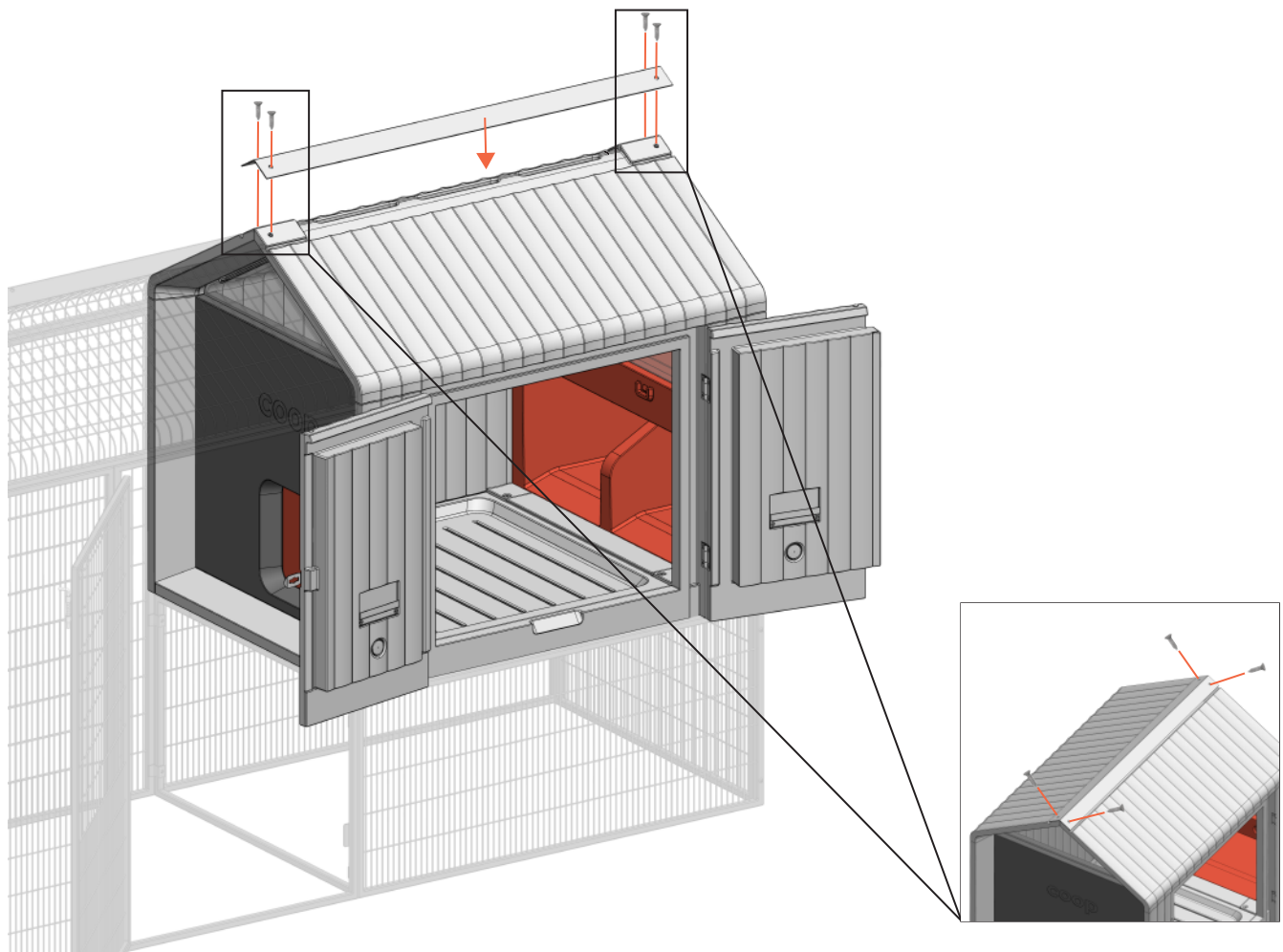

- Place the Roof Cap on top of the coop, aligning with the Roof Panels and edges.
- Secure with four 3/4" short silver screws, connecting the Roof Cap to both Roof Panels.
- Tighten the screws firmly into place. Do not overtighten as this can strip plastic.



# step #11

## what you need

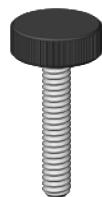

Thumb Screw

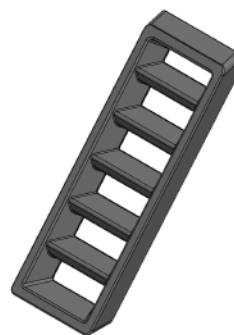

Ladder

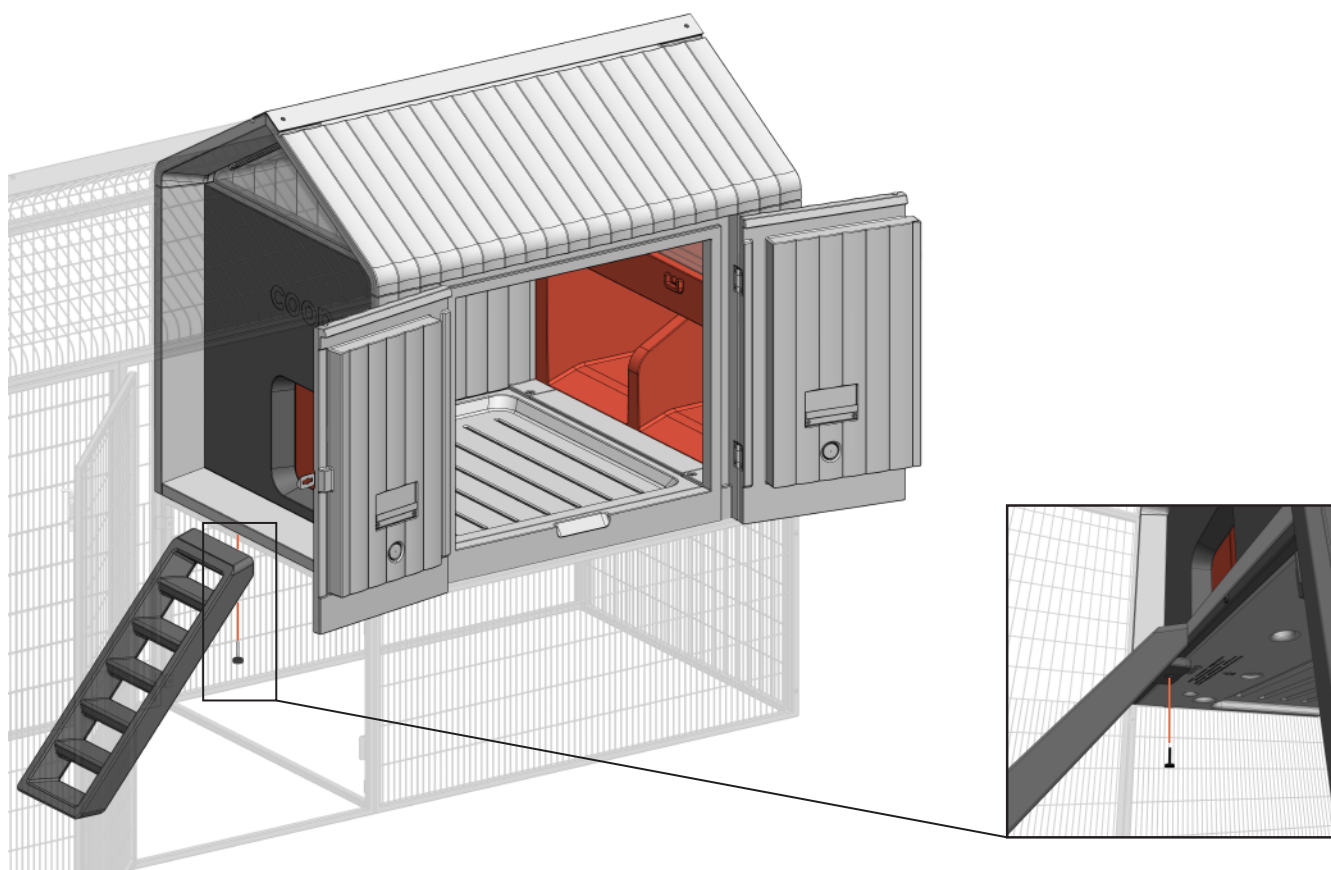

- Pretend you're a chicken and step into the Run.
- Using one Thumb Screw, connect the Ladder to the metal frame from the bottom, tightening securely into place.

## step #12

### what you need



Two Roosting Bars

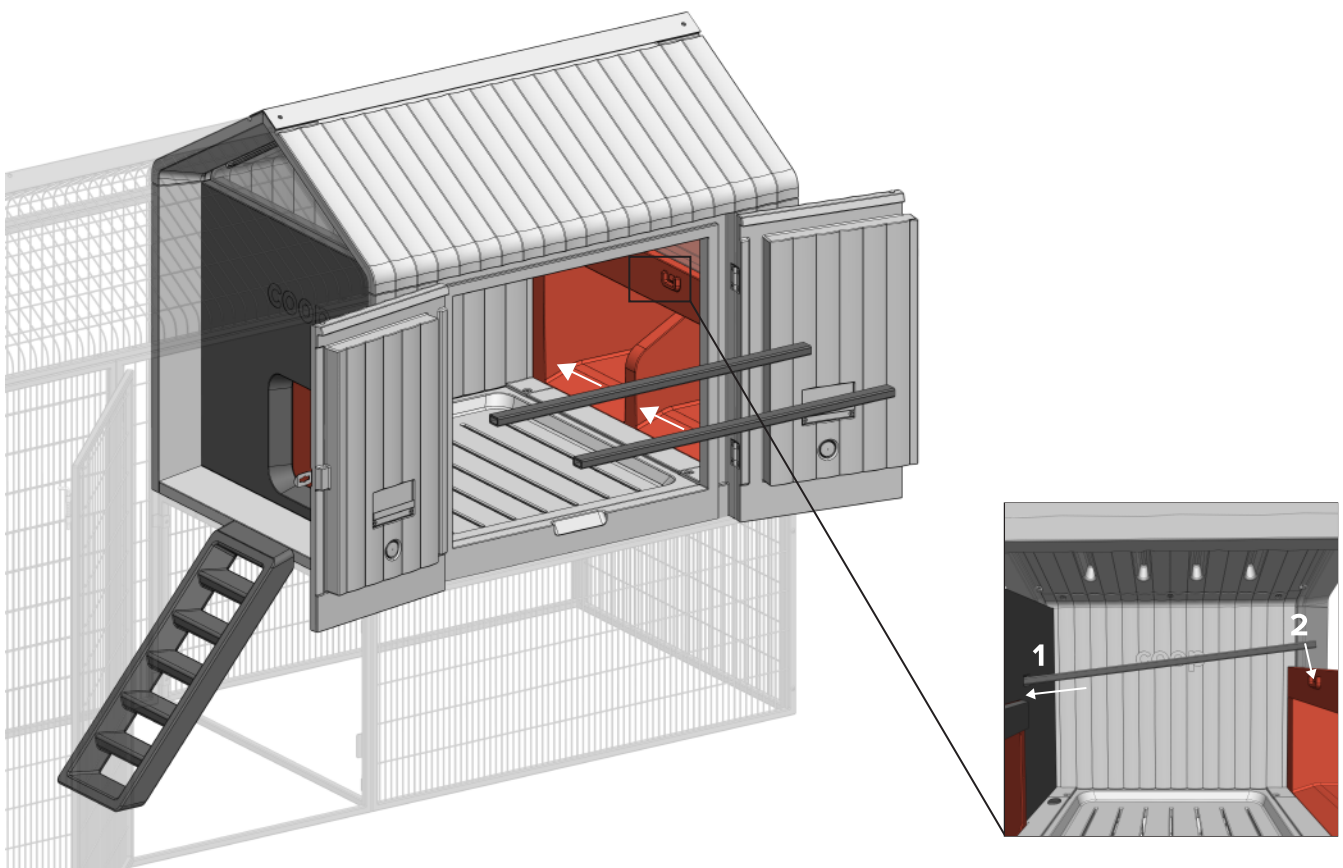

- Using access from Swing Doors, slide in each Roosting Bar from left (recesses closest to Automatic Door) to right (into the u-shaped clamp closest to the Nesting Box).
- Check to see if your Roosting Bars match the diagram and feel secure. This ensures the chickens have a comfortable and safe place to rest.
-

## step #13

### what you need

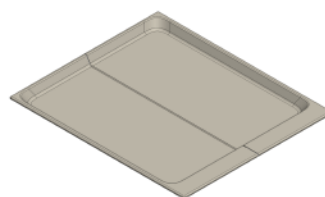

Compostable Litter Tray

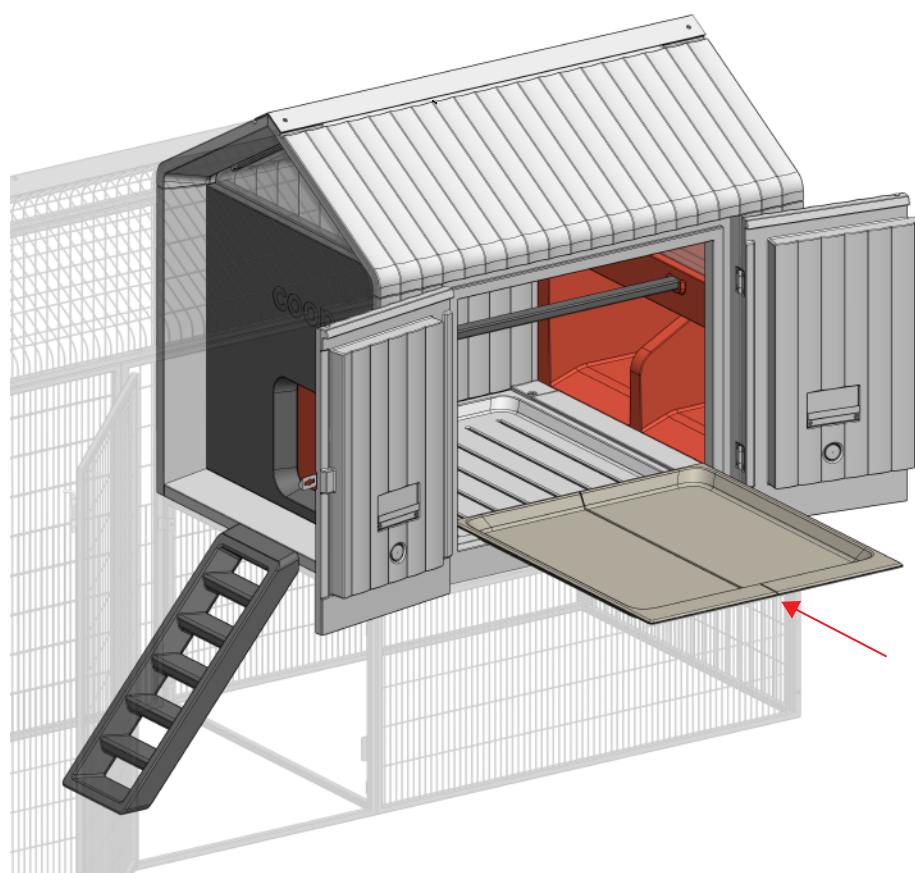

- Slide the tray into the designated recessed area on the floor of the Coop, with “Bwok-Bwok!” closest to you.
- Ensure the tray fits securely and is positioned correctly within the coop.

# placement of waterer and feeder

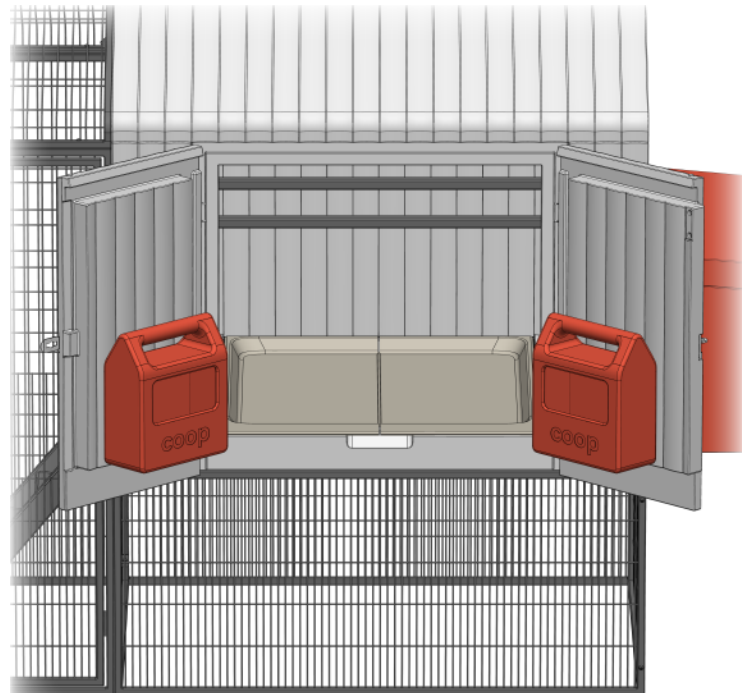
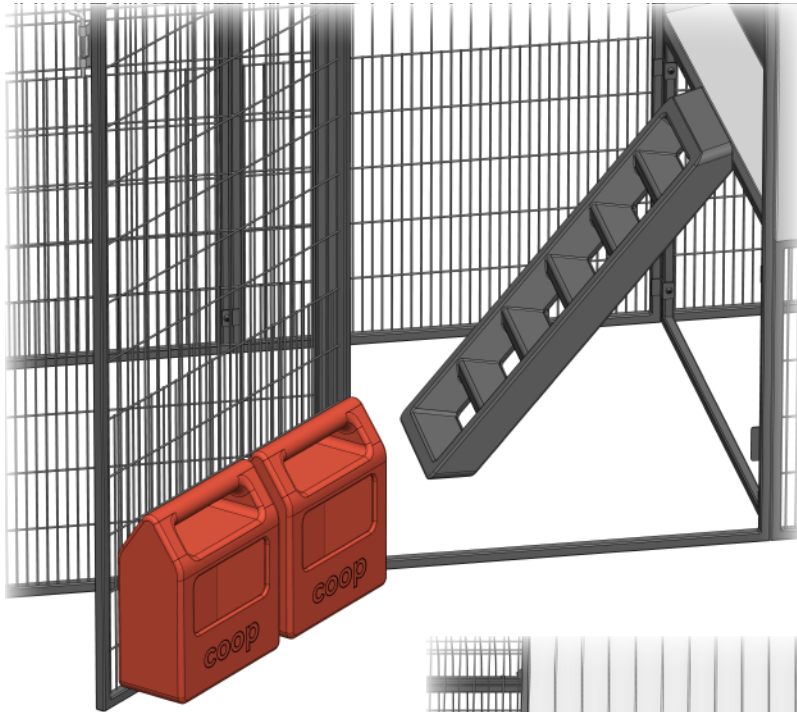

- Mount the waterer and feeder either anywhere on the wire mesh of the Run, choosing a suitable location for easy access.
- Chickens prefer having access to food and water outside the coop during the day, so attach accordingly.

# automatic chicken door activation

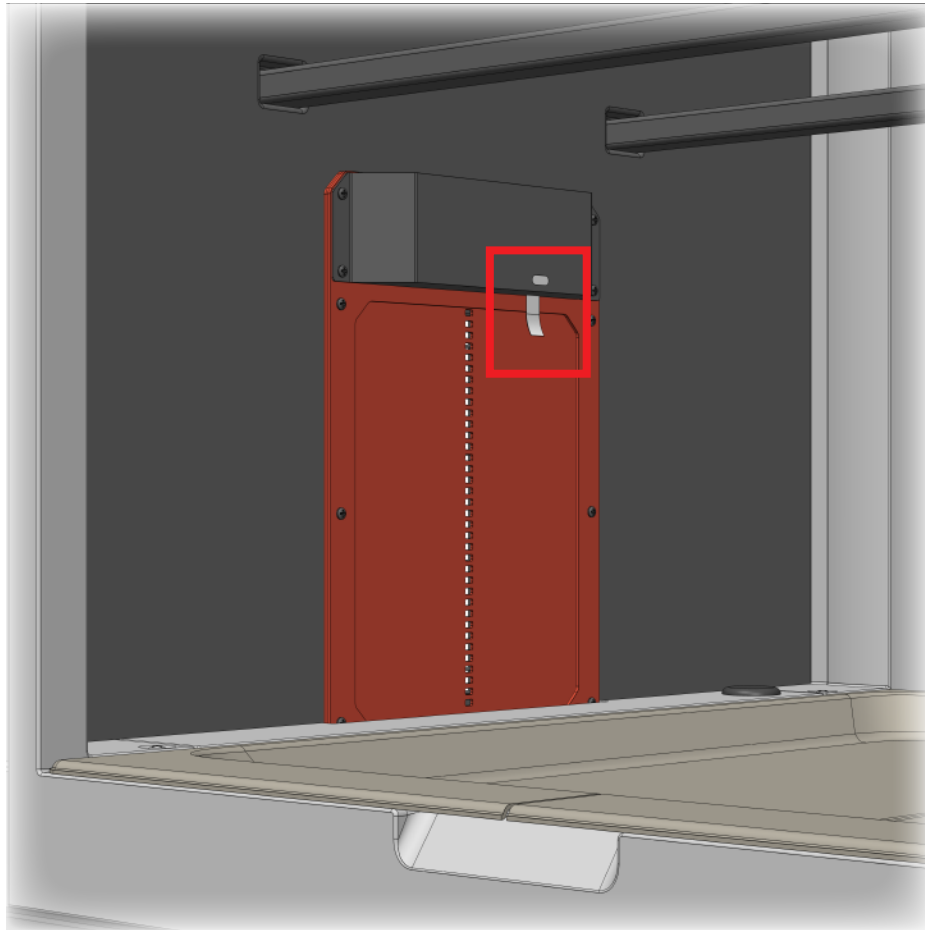

- To activate the Automatic Chicken Door, simply pull the plastic tab out of the black box at the top of the door. This will sync the pre-installed batteries, and activate the auto-open and close functions.
- Your Automatic Chicken Door will now open every morning at sunrise, and close every evening at sunset. The pre-installed batteries will last for a full year.
- You can find more information below about operating and trouble-shooting your Automatic Chicken Door.

# installing cameras

Download the Coop App from the App Store, and follow the in-app instructions to complete setup of your cameras.



Note: We're working hard on finishing our Android App, but in the meantime, all Android users can access our web-based version.

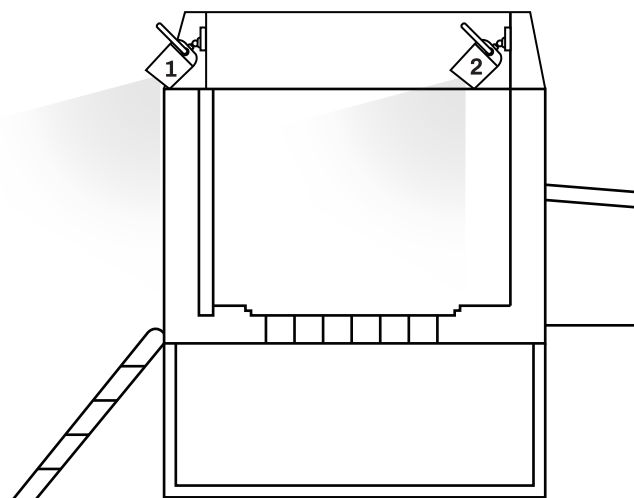

Once you've successfully completed your account setup and both cameras are online and streaming video, you can install them in your Coop.

The cameras are identical. You differentiate between external (Run Cam) and internal (Roost Cam) in the Coop App.

Simply screw into pre-installed mounts, turning clockwise until secure. Easily adjust the view by reversing if needed.

## **Assembly complete!**

**Congratulations, farmer! Fresh eggs daily await! We're so grateful you're part of our flock.**

# **Additional Camera & Door operating guides**

# Automatic Chicken Door



**operating details**



# door activation

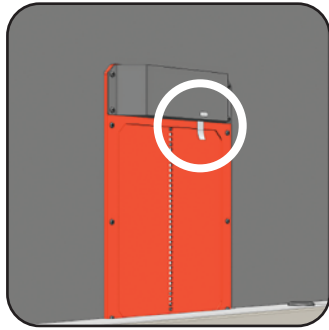

Simply pull the plastic tab from the black battery compartment. This will activate **FACTORY SETTINGS MODE**. Your door is now programmed to automatically open at sunrise and close at sunset. That's it!

The default **FACTORY SETTINGS MODE** is designed to work exceptionally well with chicken's behavior, mirroring their natural morning and evening patterns. 95% of farmers use this default mode. However, if you'd like to fine-tune your daily settings, scan the QR code on the back of this guide.

# manual commands

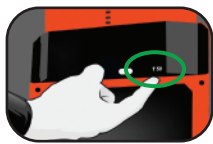

Should you need to open or close your Door outside of the automatic sunrise and sunset events, locate the button at the right bottom of black battery compartment. Press the button and use the below light indicator guide:

 **UP**

If you see GREEN LED after pressing the BUTTON, the door will go up.

 **DOWN**

If you see RED LED after pressing the BUTTON, the door will go down. To stop the door inbetween press the BUTTON again.

   **FACTORY RESET**

If you hold the button for 15 seconds the Door will reset to **FACTORY SETTINGS MODE**. LED will sequentially run through **green**, **red** and **blue** colors.

# LED status



A **blinking red light** after the door is fully opened or closed typically indicates the batteries are dead and need immediately replacing.

A blinking red light can also indicate that the door is unable to close because of dirt or debris. To troubleshoot, clean the door as instructed further.



A **blinking blue light** indicates the door is in preparing mode to open or close.

# battery replacement



**Step 1.** Locate and unscrew four screws, one in each corner of the black housing where the motor unit and batteries are located.

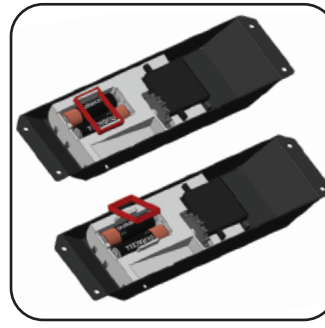

**Step 2.** Remove the square battery plate and old batteries. Replace with 2 AA alkaline batteries and re-attach the plate.

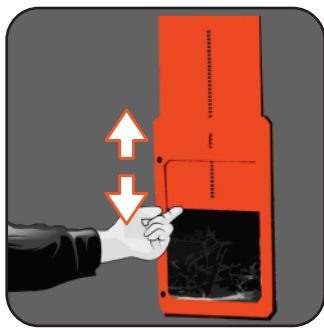

**Step 3.** Before re-attaching the motor unit, manually test the door to ensure it is opening and closing smoothly.

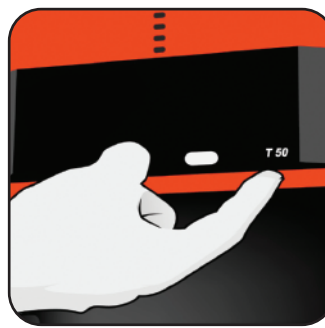

**Step 4.** Using the same four screws, screw the motor unit back into place. Press the button to confirm the door is opening and closing normally.

## DO



Regularly wipe and clean the Door with a cloth and warm water to remove dirt inside crevices. During the winter, ensure the door remains dry and no ice buildup occurs.



To keep your Door operating smoothly in harsh weather, replace the batteries with 2 AA alkaline yearly in December.

## DON'T



Don't use any lubricant (e.g. WD-40). Greas will damage the mechanics.



Don't use rechargeable batteries, as differences in voltage can impact Door functionality.



Never use a pressure washer directly on the Door or battery compartment as it can lead to electronics damage and potential short circuiting.



# CoopCam



**operating details**

# about coopcam

Your Run and Roost Cams are smart battery powered WiFi cameras that utilize the intelligence of our famous Albert Eggstein. Albert provides meaningful help day and night in taking care of your chickens - a 24/7 AI guardian. Precise predator detection, remote monitoring, egg alerts and more - Albert is always watching.

Some important notes:

- Your cameras come pre-charged in the boxes to about 50%. You can start using them right away, but ensure you charge to full capacity within the first two weeks.
- Coopcams perform best in temperatures between 14°F and 122°F (-10°C and 50°C), with humidity below 95%. They may not function as expected outside of this range.
- Cameras work with 2.4GHz Wi-Fi. Position your coop within 100-150 feet of your router when installing in your backyard. If you have trouble pairing your cameras, reach us at [help@coop.farm](mailto:help@coop.farm).

# camera structure

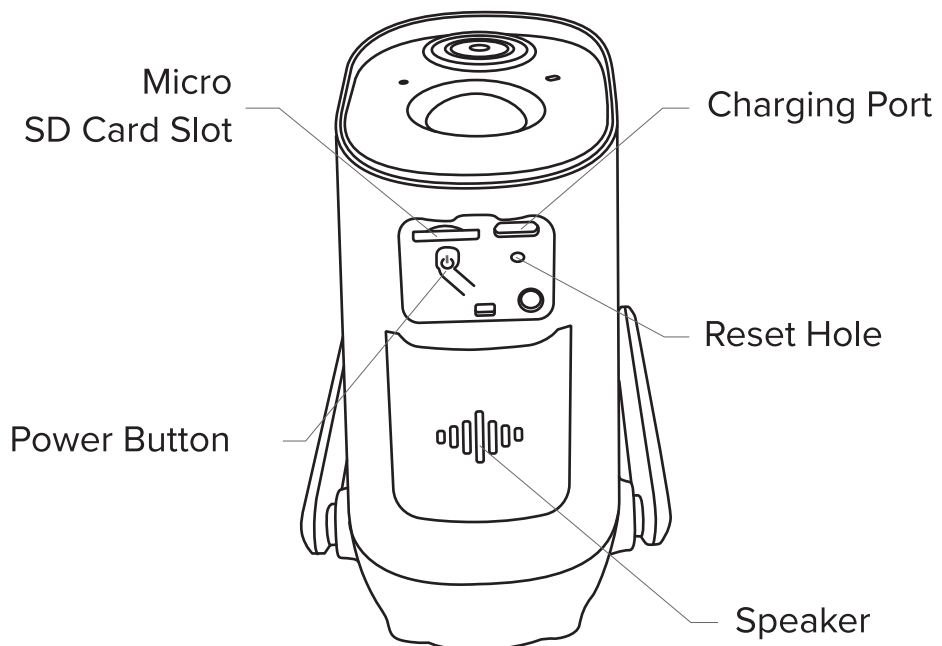
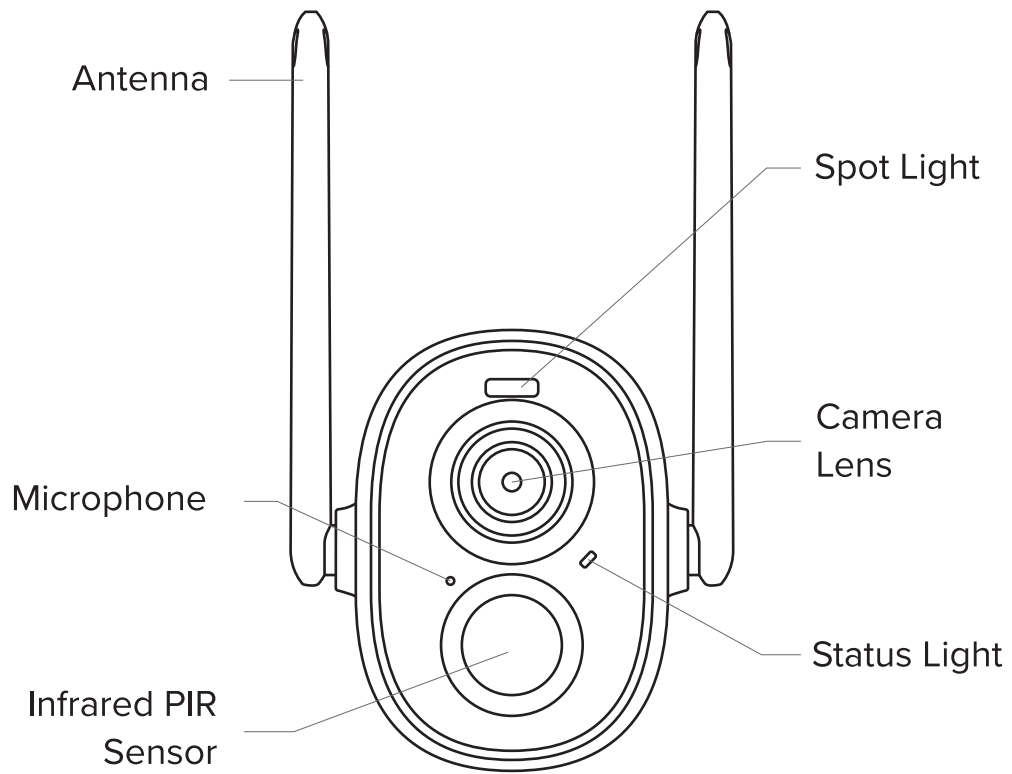

# turning the camera on & off

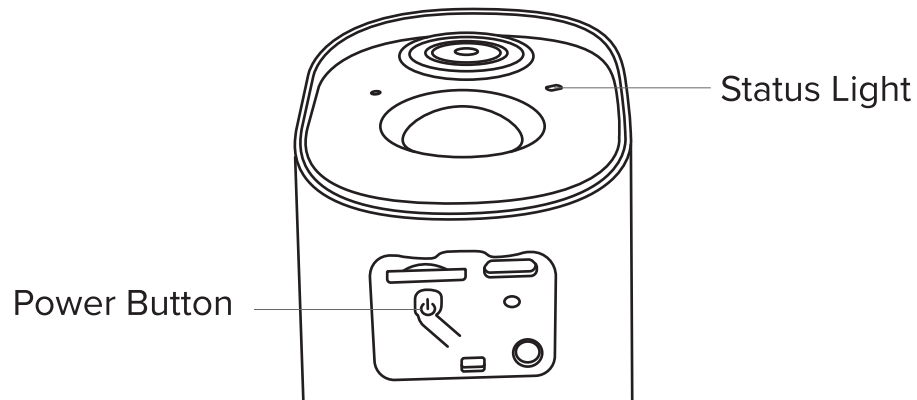

## **To turn on:**

Press and hold the power button for 3 seconds. Once the status light is solid blue, double-click the power button to enter the Wi-Fi pairing mode, and listen for a soft tone to indicate pairing mode activation.

## **To turn off:**

Press and hold the power button for 3 seconds, waiting for the status light to shut down.

# battery charging

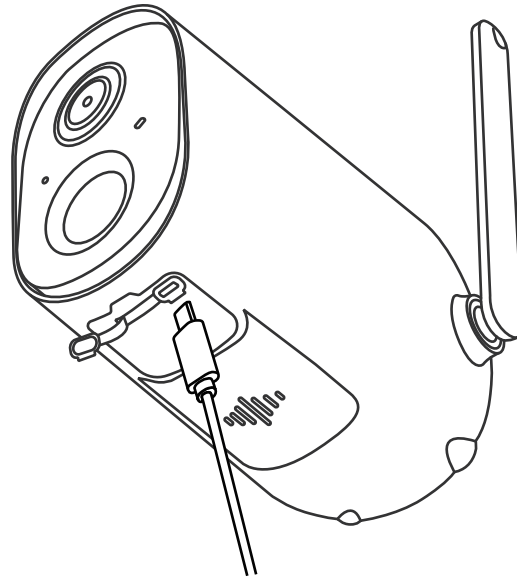

Easily charge your CoopCams with a micro-USB cable. Fully charge the camera batteries during the day to prevent interruptions to nighttime surveillance. Charging can take up to 14 hours depending on how depleted they are.

The status light will be yellow when charging and green when fully charged. Enjoy up to 30 days of battery life on a single full charge!

# status light

The CoopCams use LED status lights, located on the front panel, to show activity:

Status Light	Description
None	Offline or Standby
Blue Light	Online
Yellow Light	Charging mode
Green Light	Fully charged mode



# frequently asked questions

## **Q1: Will the camera show red lights when night vision is activated?**

The built-in infrared lamp LEDs make the camera only show some dim red lights when night vision is activated, but the image quality is still clear under no light environment.

## **Q2: What are the requirements for Wi-Fi?**

Please use a 2.4GHz wireless network. Most smart home products are only compatible with 2.4GHz wireless networks, not 5GHz. Make sure your Wi-Fi is set with a WPA2-PSK authentication method (meaning a password is required.)

## **Q3: How far should the camera be placed from the router?**

After months of testing, the Wi-Fi connection distance can normally reach up to 150 feet in the open area. However, this can depend on the strength of Wi-Fi and its surrounding environment. If the camera connection signal is weak or unstable, please relocate your structure closer to your router.

## **Q4: How to reset the camera to factory settings?**

Long press the power button for 3 seconds to restart it. If there is no response, you can remove the rubber plug at the bottom of the camera. Press the button in the reboot hole with a pin to restart the camera.

# FCC warning

NOTE: This camera equipment has been tested and found to comply with the limits for a Class B digital device, pursuant to part 15 of the FCC Rules. These limits are designed to provide reasonable protection against harmful interference in a residential installation. This equipment generates uses and can radiate radio frequency energy and, if not installed and used in accordance with the instructions, may cause harmful interference to radio communications. However, there is no guarantee that interference will not occur in a particular installation. If this equipment does cause harmful interference to radio or television reception, which can be determined by turning the equipment off and on, the user is encouraged to try to correct the interference by one or more of the following measures:

- Reorient or relocate the receiving antenna.
- Increase the separation between the equipment and receiver.
- Connect the equipment into an outlet on a circuit different from that to which the receiver is connected.
- Consult the dealer or an experienced radio/TV technician for help.

The antennas used for this transmitter must be installed to provide a separation distance of at least 20 cm from all persons and must not be co-located for operating in conjunction with any other antenna or transmitter.

FCC (USA) 15.9 prohibition against eavesdropping except for the operations of law enforcement officers conducted under lawful authority, no person shall use, either directly or indirectly, a device operated pursuant to the provision of this part for the purpose of overhearing or recording the private conversations of others unless such use is authorized by all parties engaging in the conversation. Changes or modifications not expressly approved by the party responsible for compliance could void the user's authority to operate the equipment.

FCC ID: 2AXBN-GC7  
Camera Mode: GC7  
Manufactured in P.R.C.

**farm your yard.™**

[www.coop.farm](http://www.coop.farm)

15807 Booth Circle, Volente, TX, USA 78641

(c) Coop, Inc. 2023

Model: CPBSV11

p/n 100-719 rev. October 2023

Designed in Texas, made in U.S.A.