

HELIOS®



Model: HS-1508PC
Helios 8 Outlet Optimized Power Distribution + Protection Unit

Introduction

The HELIOS HS-1508PC revolutionizes rackmount power with Optimized Non-Sacrificial Surge Suppression - no more degraded performance or sudden failures after a spike. This 1U powerhouse boasts 8 switched outlets; 6 Standard Current plus 2 High-Current outlets for demanding gear. 70d EMI/RFI noise filtering ensures pristine audio and video, while a display and intuitive LED indicators keep you informed. Plus, removable rack ears, rubber feet, and a right-angle power cord offer maximum flexibility.

Features

- 8 Switched Black Outlets (6 Standard Current + 2 High-Current)
- Optimized Non-Sacrificial Surge Suppression for Lasting Peace of Mind
- Crystal-Clear Audio and Video with 70dB EMI/RFI Noise Filtering on all Outlets
- Intuitive 1.9" LCD Display for Volts, Current, AMPS and Clear LED Indicators for Protected, Ground, Safe Voltage
- Front Outlet Power and Dimmer buttons
- Included Optional Rack Ears and Pre-Mounted Premium Rubber Feet
- 1U Rackmount Form Factor
- Right-Angle Plug 8 ft Power Cord for Convenient Placement
- 120V 15A Power Rating
- Overvoltage & Undervoltage Shut-Off Protection
- cULus Certified

Specifications

Model	HS-1508PC
Product Name	8 Outlet Rack Mount Power Distribution Unit
Color	Black Brushed aluminum
Total Outlets	8 (Rear Panel)
Standard Current - Switched	6 (Rear Panel)
High Current - Switched	2 (Rear Panel)
Outlet Color	Black
Input	Fixed Cord
AC Power Rating	120V, 15A
Power Cord	8 Ft, 14 Gauge
Power Cord Plug	Right Angle - Flat
Surge Protection Technology	Optimized Non-Sacrificial Surge Suppression
Form Factor	1U Rack or Shelf Mount - Detachable Rack Ears
EMI/RFI Noise Filtering	70 dB
LED INDICATOR	Protected, Ground, Safe Voltage
Power Button ON/OFF	Yes, switch for outlets
LCD display	1.9" LCD screen with white text
Overvoltage protection	Yes - Overvoltage & Undervoltage shut off
Circuit Breaker	Yes - 15A

Component Description

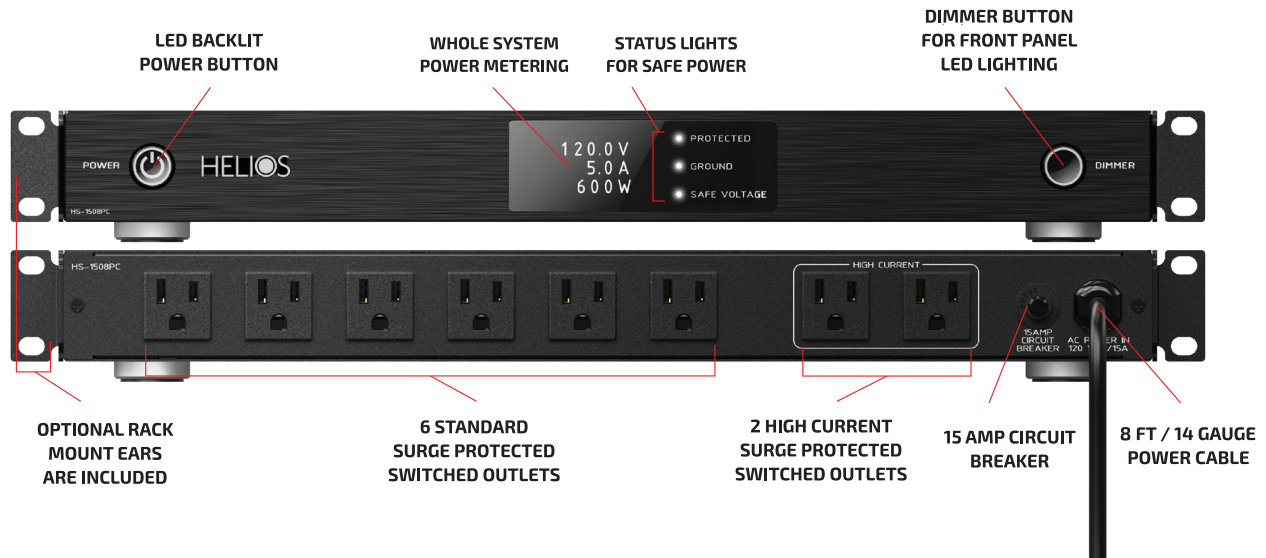

- A. LED Backlit Power Button
- B. Whole System Power Metering
- C. Status Lights for Safe Power
- D. Dimmer Button for Front Panel LED Lighting
- E. Optional Rack Mount Ears are Included
- F. 6 Standard Current Surge Protected Switched Outlets
- G. 2 High Current Surge Protected Switched Outlets
- H. 15 Amp Circuit Breaker
- I. 8FT – 14 Gauge Power Cable

LCD Screen

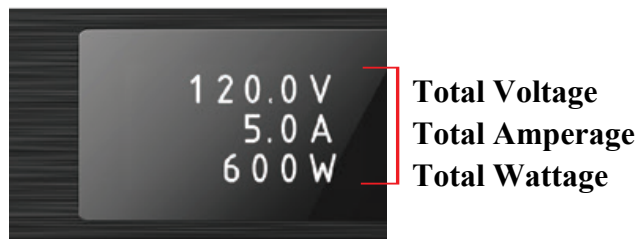

LED Indicators

Protected:

ON: Surge Protection is operational

OFF: Surge Protection is not operational (Do Not Use)

Ground:

ON: PDU is grounded correctly

OFF: PDU is not grounded correctly (Do Not Use)

Safe Voltage:

ON: Normal/Good Voltage is provided to the PDU from the service

OFF: Over/Under Voltage is provided to the PDU from the service

Installation

Rack Mount

1. Use the included thumb screws to attach the Rack Mount ears to the PDU near the face or rear of the PDU
2. Slide the PDU into the rack where you intend to mount it
3. Secure the PDU using the appropriate screws for your rack

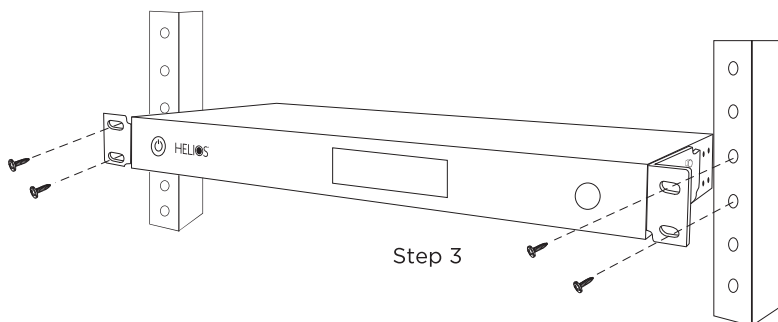
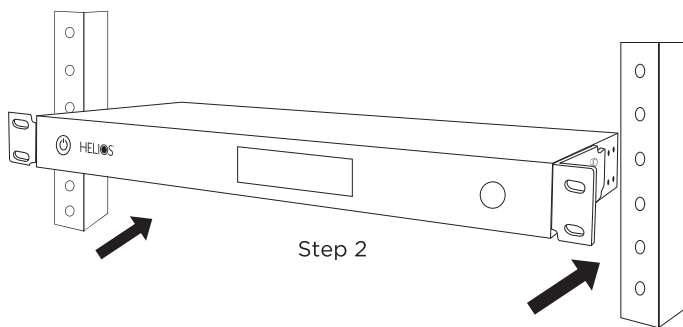
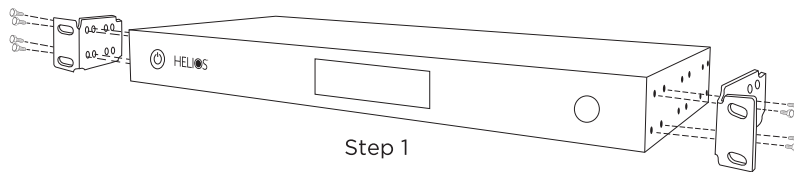

Surface Mount

1. There are multiple locations available for the Rack Ears to match to your application
2. Install appropriate surface mount screws (not included) through the Rack Mount ears into the desired surface

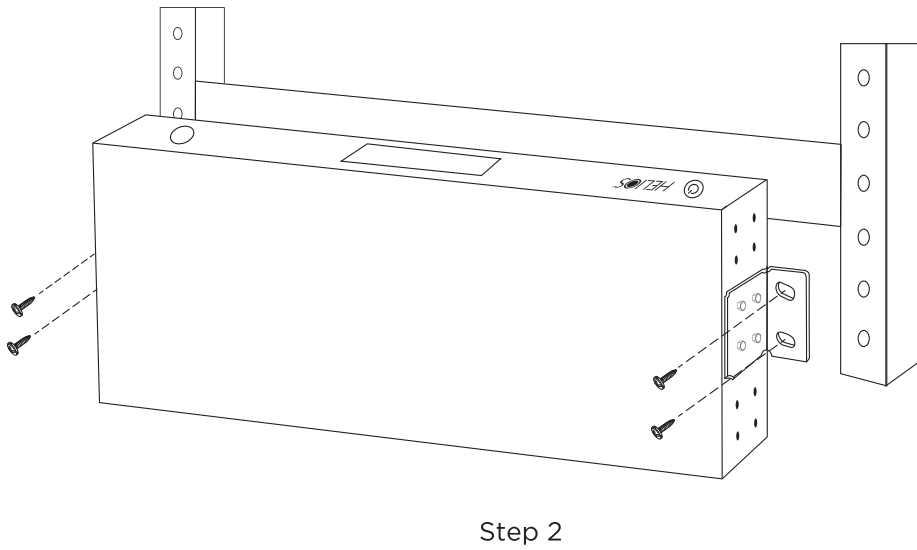
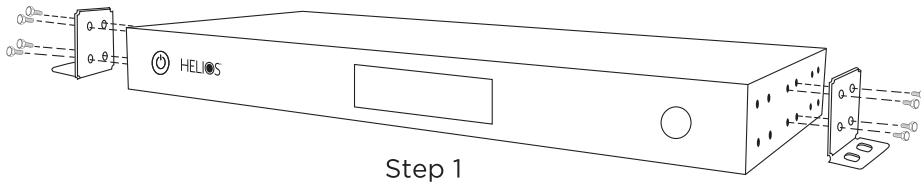

Shelf Mount

- 1. Slide the PDU onto shelf
- 2. Place PDU on Shelf

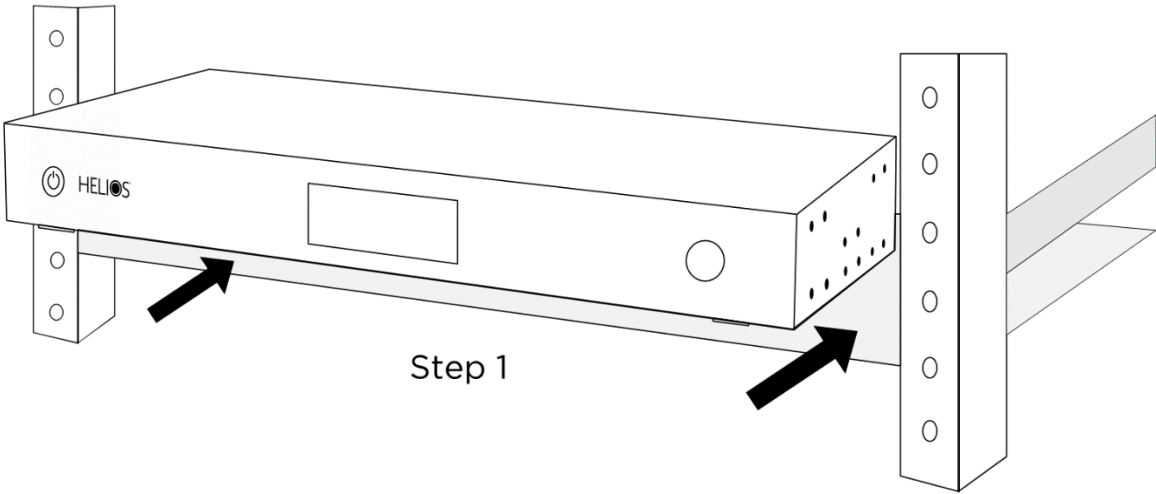

Step 1

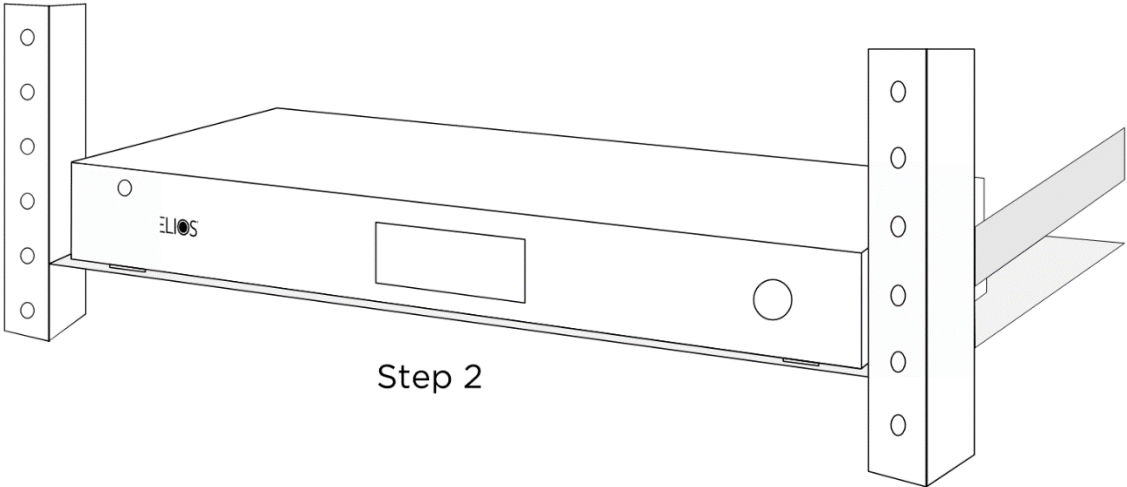

Step 2

Usage

Item	Function Description	
Boot up		During the boot up process, the Safe Voltage LED will Flash for 5 seconds. During this time the Power button will not function and the power to the outlets will remain off.
Safe voltage protection	Over Voltage	<p>When the input voltage is above 138VAC (+/-5VAC), the Safe Voltage LED flashes, and power to the outlets is turned off.</p> <p>Afterwards, when the input voltage lowers below 130VAC +/-5VAC, the Safe voltage LED flashes for 5 seconds then Safe Voltage LED is turned back on, and power to the outlets is turned on.</p> <p>For models with TFT LCD display, the content of LCD turns to red color. After input voltage is in safe range, the content of LCD turns to white color.</p>
	Under Voltage	<p>When the input voltage is below 88VAC (+/-5VAC), the Safe Voltage LED flashes, and power to the outlets is turned off.</p> <p>Afterwards, when the input voltage rises above 100VAC (+/-5VAC), the Safe Voltage LED flashes for 5 seconds then Safe Voltage LED is turned back on, and power to the outlets is turned on.</p> <p>For models with TFT LCD display, the content of LCD turns to red color. After input voltage is in safe range, the content of LCD turns to white color.</p>
Button	Dimmer	<p>When the dimmer button is pressed one time, the brightness increases by one level until 100%, if it is pressed again the brightness returns to 0%, and then repeats.</p> <p>There are 4 levels of brightness; 0%, 30%, 70%, or 100%. The factory default is 70%</p>
	POWER	If the outlets are off and the Power Button is pressed, the outlets will turn on. Conversely, if the outlets are on and the Power Button is pressed, the outlets will turn off.
Automatic memory		The current status of the LED Brightness and Outlet On or Off state will be automatically memorized after 10 seconds. If power is lost and then restored, the PDU will return to its previous state.
Factory default		<p>If necessary, a Factory Reset can be performed by pressing and holding the Dimmer button for 10 seconds to restore the original settings. After the setting is completed, all LEDs including the button LEDs will flash for 3 seconds.</p> <p>Factory default settings: Power On and Dimmer 70%</p>

Important Safety Instructions

Read and observe the following safety points at all times.

Notice

For indoor use only. Internal components are not sealed for protection from the environment. The device can only be used in a fixed location such as a telecommunication center, or a dedicated computer room. When you install the device, ensure that the protective earthing connection of the socket-outlet is verified by a qualified person. Suitable for installation in Information Technology Rooms to power ITE equipment such as Monitors, Computers, Etc. Only use brackets/attachments/accessories specified by the manufacturer. Do not place the device in an unstable position where it might fall and cause injuries. This equipment is not suitable for use in locations where children are likely to be present. Do not cover this device with a cloth. Do not install it on a carpet or rug. **There are no replaceable parts. Do not attempt to disassemble this unit for any reason.**

Caution

Potential injury

Do not use this product with extension cords, multi-outlet power strips, multi-outlet extenders, or UPS devices. The power capacity of these accessories can be overloaded by this product and may result in a risk of fire, or property damage. Do not exceed 15 Amps total draw

Exposure to Heat

Do not expose the PDU to direct sunlight or place it near wall heaters, space heaters, or in an enclosed space prone to temperature increase. Do not use the device in a confined, poorly-ventilated location; this can overheat the unit, possibly even causing a fire. If used in a small space other than an EIA-standard rack, ensure that there is adequate space around the device.

Proper Cleaning

In general, the only cleaning necessary for is light dusting. Unplug the PDU from the wall outlet before cleaning it. Do not use liquid or aerosol cleaners. To reduce the risk of electrical shock, unplug the HS-1508PC and allow it to cool before cleaning.

Warning

Power sources, grounding, and polarization

This plug is designed to be inserted into a NEMA 5-15 (three-prong grounded) outlet only. Do not force the plug into an outlet that is not designed to accept it. Never dismantle the plug or to alter the power cord, and do not attempt to defeat the grounding feature by using a 3-to-2 prong adapter. If you have questions about grounding, consult your local power company or a qualified electrician. This PDU requires a properly grounded outlet for safety. If you're not sure if your home's electrical wiring is properly grounded, have it checked by a qualified electrician. If a rooftop device such as a satellite dish connects to the PDU, ensure that the device's wires are also properly grounded.

Liquid: avoiding electrical shocks

Do not operate the PDU if liquid of any kind is spilled onto or inside the unit. Do not operate it near rain or water, even water that is contained (for example, bathtub or sink).

Power cord safety

Do not place the power cord near areas with heavy foot traffic (for example, hallways). Do not create a trip hazard with the power cord. If the power cord's protective jacket rips or frays, exposing the internal wiring or shielding, disconnect it from the power source and replace the power cord immediately. See the warranty section of the owner's manual for details.

No User-Serviceable Parts Inside

If the PDU is not operating properly, do not remove any part of the unit (cover, etc.) for repair. Unplug the unit and consult the warranty section of the owner's manual.

FCC Warning

WARNING!! Changes or modifications to this unit not expressly approved by the party responsible for compliance could void the user's authority to operate the equipment. This equipment has been tested and found to comply with the limits for a Class B Digital Device, pursuant to Part 15 of the FCC Rules. These limits are designed to provide reasonable protection against harmful interference in residential installation. This equipment generates, uses and can radiate radio frequency energy and, if not installed and used in accordance with the instruction manual, may cause harmful interference to radio communications. However, there is no guarantee that interference will not occur in a particular installation. If this equipment does cause harmful interference to radio or television reception, which can be determined by turning the equipment off and on, the user is encouraged to try to correct the interference by one or more of the following measures:

- Reorient or relocate the receiving antenna.
- Increase the separation between the equipment and receiver.
- Connect the equipment into an outlet on a circuit different from that to which the receiver is connected.
- Consult the dealer or an experienced radio/TV technician for help.

Notice: (1) An unshielded-type power cord is required in order to meet FCC emission limits and also to prevent interference to the nearby radio and television reception. It is essential that only the supplied power cord be used. (2) Use only shielded cables to connect I/O devices to this equipment.

Note: THE MANUFACTURER IS NOT RESPONSIBLE FOR ANY RADIO OR TV INTERFERENCE CAUSED BY UNAUTHORIZED MODIFICATIONS TO THIS EQUIPMENT. SUCH MODIFICATIONS COULD VOID THE USER'S AUTHORITY TO OPERATE THE EQUIPMENT.

The Class B digital apparatus meets all requirements of the Canadian Interference-Causing Equipment Regulation

Cet appareil numérique de la class B respecte toutes les exigences du Règlement sur le matériel brouilleur du Canada.

FCC Part 15B + ICES-003: Issue 7 Warning

This equipment has been tested and found to comply with the limits for a Class B digital device, pursuant to Part 15 of the FCC Rules. These limits are designed to provide reasonable protection against harmful interference in a residential installation. This equipment generates, uses and can radiate radio frequency energy and, if not installed and used in accordance with the instructions, may cause harmful interference to radio communications. However, there is no guarantee that interference will not occur in a particular installation. If this equipment does cause harmful interference to radio or television reception, which can be determined by turning the equipment off and on, the user is encouraged to try to correct the interference by one or more of the following measures:

- Reorient or relocate the receiving antenna.
- Increase the separation between the equipment and receiver.
- Connect the equipment into an outlet on a circuit different from that to which the receiver is connected.
- Consult the dealer or an experienced radio/TV technician for help.