

GARMIN®

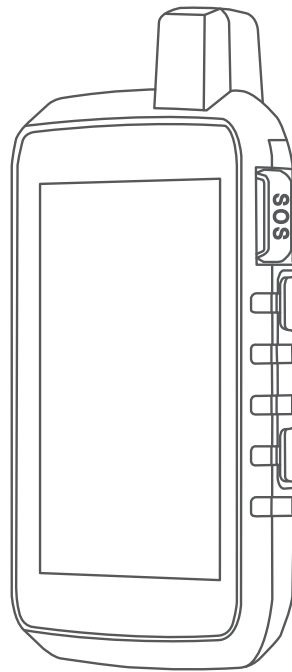

MONTANA® 700 SERIES

Owner's Manual

© 2020 Garmin Ltd. or its subsidiaries

All rights reserved. Under the copyright laws, this manual may not be copied, in whole or in part, without the written consent of Garmin. Garmin reserves the right to change or improve its products and to make changes in the content of this manual without obligation to notify any person or organization of such changes or improvements. Go to www.garmin.com for current updates and supplemental information concerning the use of this product.

Garmin®, the Garmin logo, ANT+®, Auto Lap®, AutoLocate®, City Navigator®, inReach®, Montana®, TracBack®, VIRB®, and Xero® are trademarks of Garmin Ltd. or its subsidiaries, registered in the USA and other countries. BaseCamp™, chirp™, Connect IQ™, Garmin Connect™, Garmin Explore™, Garmin Express™, Garmin HuntView™, Garmin Messenger™, Garmin Response™, and tempe™ are trademarks of Garmin Ltd. or its subsidiaries. These trademarks may not be used without the express permission of Garmin.

Android™ is a trademark of Google Inc. Apple®, iPhone®, and Mac® are trademarks of Apple Inc., registered in the U.S. and other countries. Applied Ballistics® is a registered trademark of Applied Ballistics, LLC. The BLUETOOTH® word mark and logos are owned by the Bluetooth SIG, Inc. and any use of such marks by Garmin is under license. iOS® is a registered trademark of Cisco Systems, Inc. used under license by Apple Inc. Iridium® is a registered trademark of Iridium Satellite LLC. microSD® and the microSDHC logo are trademarks of SD-3C, LLC. NMEA® is a registered trademark of the National Marine Electronics Association. Wi-Fi® is a registered trademark of Wi-Fi Alliance Corporation. Windows® is a registered trademark of Microsoft Corporation in the United States and other countries. Other trademarks and trade names are those of their respective owners.

This product is ANT+® certified. Go to www.thisisant.com/directory for a list of compatible products and apps.

Table of Contents

Introduction.....	1
Device Overviews.....	1
Montana 700i/710i/750i/760i Device Overview.....	1
Montana 700/710 Device Overview.....	2
Status LED.....	3
Installing the Lithium-ion Battery.....	4
Charging the Battery Pack.....	5
Charging the Device More Quickly.....	5
Long-Term Storage.....	5
Using the Power Button.....	6
Viewing the Status Page.....	6
Adjusting the Backlight.....	6
Using the Touchscreen.....	6
Locking the Touchscreen.....	6
Unlocking the Touchscreen.....	6
Activating the Device.....	7
Garmin Messenger App.....	7
Iridium Satellite Network.....	7
Acquiring Satellite Signals.....	8
Status Icons.....	8
inReach Features.....	8
Messages.....	8
Sending a Check-In Message.....	9
Sending a Text Message.....	9
Replying to a Message.....	9
Checking for Messages.....	9
Viewing Message Details.....	9
Navigating to a Message Location..	10
Including Location Coordinates in a Message.....	10
Deleting Messages.....	10
Messages Settings.....	10
inReach Tracking.....	10
Starting Tracking.....	10
Stopping Tracking.....	10
Sharing Your Tracking Page.....	11
inReach Tracking Settings.....	11
SOS.....	11
Initiating an SOS Rescue.....	12
Sending a Custom SOS Message....	12
Canceling an SOS Request.....	12
Sending a Test Message.....	13

Syncing inReach Data.....	13
Contacts.....	13
Adding a Contact.....	13
Editing a Contact.....	13
Deleting a Contact.....	13
Data Use and History.....	13
Viewing Plan Details.....	13
Viewing Data Use.....	14
Viewing the Main Pages.....	14
Map.....	14
Managing Maps.....	14
Navigating with the Map.....	14
Map Page Settings.....	14
Compass.....	15
Navigating with the Compass.....	15
Compass Settings.....	16
Trip Computer.....	17
Trip Computer Settings.....	18
Altimeter.....	18
Altimeter Plot Settings.....	18
Connected Features.....	19
Connected Feature Requirements.....	19
Pairing a Smartphone with Your Device.....	20
Phone Notifications.....	20
Connecting to a Wireless Network.....	20
Setting Up Wi-Fi Connectivity.....	20
Connect IQ Features.....	21
Downloading Connect IQ Features..	21
Downloading Connect IQ Features Using Your Computer.....	21
Garmin Explore.....	21
Wireless Headsets.....	21
Pairing a Wireless Headset with Your Device.....	21
Disconnecting or Removing a Wireless Headset.....	22
Navigation.....	22
Where To? Page.....	22
Navigating to a Destination.....	22
Finding an Address.....	22
Finding a Location Near Another Location.....	23
Waypoints.....	23

Saving Your Current Location as a Waypoint.....	23	Reversing a Course.....	33
Saving a Location on the Map as a Waypoint.....	23	Creating a Track or Route from a Saved Course.....	34
Navigating to a Waypoint.....	23	Deleting a Course.....	34
Finding a Saved Waypoint.....	24	Weather.....	34
Editing a Waypoint.....	24	Requesting an inReach Weather Forecast.....	34
Deleting a Waypoint.....	24	Updating an inReach Weather Forecast.....	35
Changing the Photo for a Waypoint.....	24	Deleting an inReach Weather Forecast.....	35
Increasing the Accuracy of a Waypoint Location.....	24	Viewing an Active Weather Forecast... ..	35
Projecting a Waypoint from a Saved Waypoint.....	25	Viewing an Active Weather Map.....	35
Moving a Waypoint on the Map.....	25	Adding an Active Weather Location.....	36
Finding a Location Near a Waypoint.....	25	Main Menu Applications.....	37
Setting a Waypoint Proximity Alarm.....	25	Customizing the Main Menu.....	38
Adding a Waypoint to a Route.....	26	Customizing and Sharing the Main Menu.....	39
Repositioning a Waypoint to Your Current Location.....	26	Garmin Adventures.....	39
Routes.....	26	Sending Files to and from BaseCamp.....	39
Creating a Route.....	26	Creating an Adventure.....	39
Creating a Route Using the Map.....	26	Starting an Adventure.....	40
Creating a Round-Trip Route.....	27	Setting an Alarm.....	40
Navigating a Saved Route.....	27	Starting the Countdown Timer.....	40
Editing a Route.....	28	Calculating the Size of an Area.....	40
Viewing a Route on the Map.....	28	Camera and Photos.....	40
Viewing the Elevation Plot of a Route.....	28	Taking a Photo.....	40
Reversing a Route.....	28	Viewing Photos.....	41
Deleting a Route.....	28	Dog Tracking.....	41
Recordings.....	28	Receiving Data From Your Handheld Dog Device.....	42
Recording Settings.....	29	Tracking Your Dogs.....	42
Viewing the Current Activity.....	30	Using the Flashlight.....	43
Navigating Using TracBack®.....	30	Geocaches.....	43
Saving the Current Activity.....	30	Registering Your Device at Geocaching.com.....	43
History.....	31	Downloading Geocaches Using a Computer.....	43
Courses.....	32	Geocache Searches.....	44
Creating a Course.....	32	Filtering the Geocache List.....	44
Creating a Course Using the Map....	32	Viewing Geocache Details.....	45
Navigating a Saved Course.....	32	Navigating to a Geocache.....	45
Editing a Course.....	33	Logging the Attempt.....	46
Viewing a Saved Course on the Map.....	33	chirp.....	46
Viewing the Elevation Plot of a Course.....	33		

- Removing Live Geocache Data from the Device..... 46
- Removing Your Device Registration From Geocaching.com..... 46
- Using the inReach Remote..... 47
- Marking and Starting Navigation to a Man Overboard Location..... 47
- Downloading Maps..... 48
 - Downloading TopoActive Maps..... 48
- Creating Map Sets..... 48
 - Editing a Map Set..... 49
 - Deleting a Map Set..... 49
- Selecting a Profile..... 49
- Setting a Proximity Alarm..... 49
 - Editing or Deleting a Proximity Alarm..... 49
 - Setting the Proximity Alarm Tones.. 49
 - Disabling All Proximity Alarms..... 50
- Satellite Page..... 50
 - GPS Satellite Settings..... 50
- Sending and Receiving Data Wirelessly..... 50
- Using the VIRB Remote..... 50

Customizing the Device..... 50

- Custom Data Fields and Dashboards.. 50
 - Enabling the Map Data Fields..... 51
 - Customizing the Data Fields..... 51
 - Customizing Dashboards..... 51
- Rotating the Screen..... 51
- Setup Menu..... 52
 - System Settings..... 53
 - Display Settings..... 54
 - Phone Settings..... 54
 - Bluetooth Audio Settings..... 54
 - Wi-Fi Settings..... 55
 - Routing Settings..... 55
 - Turning On Expedition Mode..... 55
 - Setting the Device Tones..... 55
 - Camera Settings..... 56
 - Geocaching Settings..... 56
 - Sensors Settings..... 56
 - Fitness Settings..... 57
 - Marine Settings..... 57
 - Menu Settings..... 57
 - Position Format Settings..... 58
 - Changing the Units of Measure..... 58

- Time Settings..... 58
- Accessibility Settings..... 58
- Profiles..... 59
- Resetting Data and Settings..... 60

Device Information..... 60

- Product Updates..... 60
 - Setting Up Garmin Express..... 60
 - Getting More Information..... 60
- Viewing E-label Regulatory and Compliance Information..... 61
- Installing AA Batteries..... 61
- Device Care..... 62
 - Cleaning the Device..... 62
 - Cleaning the USB Port..... 62
 - Cleaning the Touchscreen..... 62
- Data Management..... 62
 - File Types..... 62
 - Installing a Memory Card..... 63
 - Connecting the Device to Your Computer..... 63
 - Transferring Files to Your Device.... 64
 - Deleting Files..... 64
 - Using Garmin Connect..... 64
 - Disconnecting the USB Cable..... 64
- Specifications..... 65

Appendix..... 66

- Data Fields..... 66
- Optional Accessories..... 68
 - tempe..... 68
 - Tips for Pairing Wireless Sensors.... 69
- Troubleshooting..... 69
 - Maximizing Battery Life..... 69
 - Restarting the Device..... 69
 - My device is in the wrong language..... 69
- About Heart Rate Zones..... 69
 - Fitness Goals..... 70
 - Heart Rate Zone Calculations..... 70

Introduction

⚠ WARNING

See the *Important Safety and Product Information* guide in the product box for product warnings and other important information.

Device Overviews

Montana 700i/710i/750i/760i Device Overview

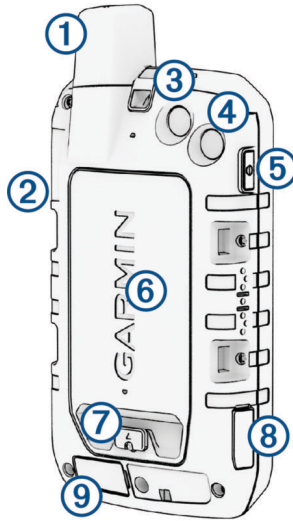

①	Iridium® and GNSS antenna
②	SOS button
③	Camera lens (Montana 750i/760i only)
④	Flashlight Camera flash (Montana 750i/760i only)
⑤	Power button I
⑥	microSD® card slot (under battery pack)
⑦	Battery pack D-ring
⑧	USB port (under weather cap)
⑨	External Iridium and GNSS antenna port (under weather cap)

Montana 700/710 Device Overview



①	GNSS antenna
②	Flashlight
③	Power button ⓘ
④	microSD card slot (under battery pack)
⑤	Battery pack D-ring
⑥	USB port (under weather cap)

Status LED

The status LED ① indicates the device status.

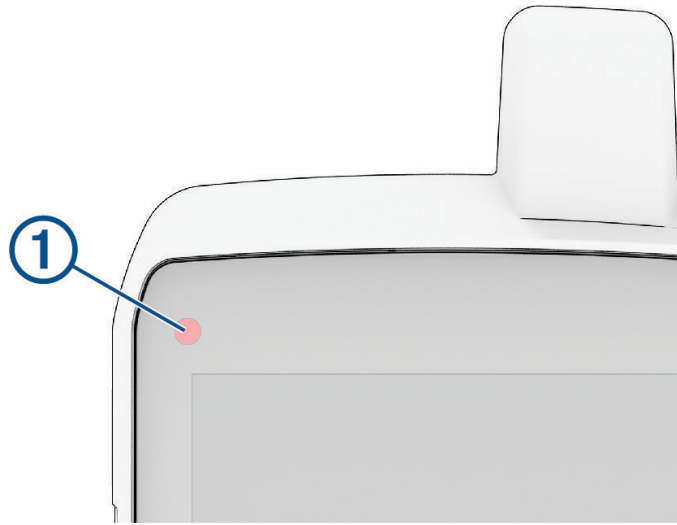

LED Activity	Status
Double flashing green	You have an unread inReach® message.
Flashing green	The device is in expedition mode. The screen is turned off to maximize battery life.
Flashing red	An inReach message failed to send.
	The device is below 10-percent battery power.
Alternating red and green flashes	The device is in SOS mode.

Installing the Lithium-ion Battery

- 1 Locate the Lithium-ion battery pack included in the product box.
- 2 Verify the gasket and battery compartment are free of debris.
- 3 Insert the battery pack into the back of the device.

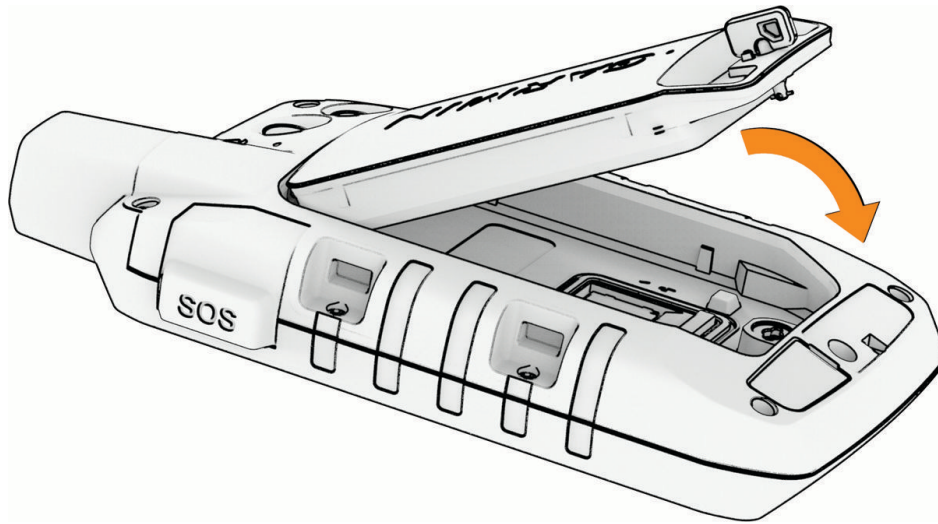

- 4 Turn the D-ring clockwise to secure the battery pack onto the device.
- 5 Press the D-ring flat against the back of the device.

You should leave the battery installed in the device to keep moisture and debris away from the battery contacts and microSD card slot.

Charging the Battery Pack

NOTICE

To prevent corrosion, thoroughly dry the USB port, the weather cap, and the surrounding area before charging or connecting to a computer.

Do not attempt to use the device to charge a battery that was not provided by Garmin®. Attempting to charge a battery that was not provided by Garmin can damage the device and void the warranty.

Before you can connect the USB cable to your device, you may need to remove optional mount accessories.

NOTE: The device does not charge when outside the approved temperature range (*Specifications, page 65*).

You can charge the battery using a standard wall outlet or a USB port on your computer.

- 1 Pull up the weather cap ① from the USB port ②.

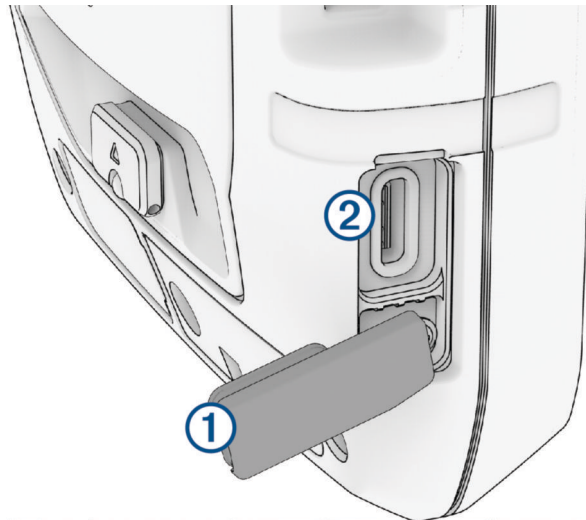

- 2 Plug the USB cable into the USB port on your device.
- 3 Plug the other end of the USB cable into an AC adapter (5 V minimum output power) or a computer USB port.
- 4 If necessary, plug the AC adapter into a standard wall outlet.

When you connect the device to a power source, the device turns on.

- 5 Charge the battery completely.

TIP: The battery gauge appears in the status bar.

Charging the Device More Quickly

- 1 Connect your device to an AC adapter.
- 2 Plug the AC adapter into a standard wall outlet.
- 3 Hold the power button until the battery gauge appears.
- 4 Hold the power button again until the screen turns off.
The device goes into a low power, battery charging mode.

- 5 Charge the device completely.





NOTE: You can view the battery gauge by pressing the power button to turn on the screen.

Long-Term Storage

When you do not plan to use the device for several months, you should charge the battery to at least 50% before you store the device. You should store the device in a cool, dry place with temperatures around the typical household level. After storage, you should fully recharge the device before using it.

Using the Power Button

By default, you can use the power button to turn the device on and off, turn off the screen, and open the status page. You can customize the power button functions (*Customizing the Power Button*, page 53).

- Press  to turn on the device.
- Press  to open the status page.
- Press  twice to turn off the screen.
TIP: You can press  to turn the screen back on.
- Hold  to turn off the device.

Viewing the Status Page

The status page displays the current activity recording, Bluetooth® and Wi-Fi® connection status, and provides quick access to frequently used functions such as marking waypoints, locking the touchscreen, and adjusting the backlight brightness.

Press  or swipe down from the top of the screen to open the status page.





Adjusting the Backlight

Extensive use of screen backlighting can significantly reduce battery life. You can adjust the backlight brightness to maximize the battery life.

NOTE: The backlight brightness may be limited when the remaining battery power is low.



- 1 Press  to open the status page.
- 2 Use the slider to adjust the backlight brightness.

Using the Touchscreen

- Tap the screen to select an item.
- Make each touchscreen selection a separate action.
- Select  to save your changes and close the page.
- Select  to close the page.
- Select  to return to the previous page.
- Select  to return to the main menu.
- Select  to view specific menu items for the page you are viewing.

Locking the Touchscreen

You can lock the screen to prevent inadvertent screen touches.

- 1 Press  to open the status page.
- 2 Select .

Unlocking the Touchscreen

Press .

Activating the Device

WARNING

Before you can use the inReach features of your Montana 700i/710i/750i/760i navigator, including messaging, SOS, tracking, and inReach Weather, you must have an active satellite subscription. Always test your device before you use it outdoors.

1 Select an option:

- From your phone, download the Garmin Messenger™ app, and follow the on-screen instructions to pair your device, create an account, and activate a service plan.
- From your computer, go to explore.garmin.com to create an account and activate a service plan.

NOTE: You must enter the device IMEI number and authorization code to complete the online portion of activation before you go outdoors.

2 Follow the on-screen instructions on your device.

3 If using a computer, go outdoors to an open area with a clear view of the sky, and point the antenna on the device toward the sky for optimal performance.

4 Wait while the device communicates with the Iridium satellite network.

NOTE: It may take up to 20 minutes to activate your device. The device must send and receive several messages, which takes longer than sending a single message during regular use. Your device should remain outdoors until activation completes.

Garmin Messenger App

WARNING

The inReach features of the Garmin Messenger app, including SOS, tracking, and inReach Weather, are not available without a connected inReach satellite communicator and an active satellite subscription. Always test the app outdoors before using it on a trip.

CAUTION

The non-satellite messaging features of the Garmin Messenger app alone should not be relied on as a primary method to obtain emergency assistance.

NOTICE

The app works over both the internet (using a wireless connection or cellular data on your phone) and the Iridium satellite network. If you are using cellular data, your paired phone must be equipped with a data plan and be in an area of network coverage where data is available. If you are in an area without network coverage, you must have an active satellite subscription for your inReach satellite communicator to use the Iridium satellite network.

You can use the app to message other Garmin Messenger app users, including friends and family without Garmin devices. Anyone can download the app and connect their phone, allowing them to communicate with other app users over the internet (no login is required). App users can also create group messaging threads with other SMS phone numbers. New members added to the group message can download the app to see what others are saying.

Messages sent using a wireless connection or cellular data on your phone do not incur data charges or additional charges on your satellite subscription. Messages received may incur charges if message delivery is attempted over both the Iridium satellite network and the internet. Standard text messaging rates for your cellular data plan apply.

You can download the Garmin Messenger app from the app store on your phone (garmin.com/messengerapp).

Iridium Satellite Network

Your device requires a clear view of the sky to transmit messages and track points over the Iridium satellite network. Without a clear view of the sky, your device attempts to send the information until it acquires satellite signals.

TIP: For the best connection with satellites, hold the device with the antenna pointed toward the sky.











Acquiring Satellite Signals

It may take 30 to 60 seconds to acquire satellite signals.

- 1 Go outdoors to an open area.
- 2 If necessary, turn on the device.
- 3 Wait while the device searches for satellites.
 - ? flashes while the device determines your GNSS location.
 - in the status bar shows the satellite signal strength.

When the device acquires satellite signals, it automatically starts recording your path as an activity.

Status Icons

	ANT+® sensor status
	GPS signal strength
	Charging battery
	Charging complete
	Bluetooth technology status
	Wi-Fi status
	Sending, receiving, or searching for inReach messages and tracking points
	Unread inReach messages
	inReach tracking status
	Touchscreen locked

inReach Features

⚠ WARNING

Before you can use the inReach features of your Montana 700i/710i/750i/760i device, including messaging, SOS, tracking, and inReach Weather, you must have an active satellite subscription. Always test your device before you use it outdoors.

Ensure you have a clear view of the sky when using the messaging, tracking, and SOS functions, because these features require satellite access to operate properly.

NOTICE

Some jurisdictions regulate or prohibit the use of satellite communications devices. It is the responsibility of the user to know and follow all applicable laws in the jurisdictions where the device is intended to be used.

Messages

Your Montana 700i/710i/750i/760i satellite communicator sends and receives messages using the Iridium satellite network. You can send messages to an SMS phone number, an email address, or another device that uses inReach technology. Each message you send includes your location details where allowed.

Sending a Check-In Message

Check-in messages have predefined text and predetermined recipients. Check-in messages must be set up on the Garmin Explore™ website at explore.garmin.com.

- 1 Select **inReach** > **Messages** > **Send Check-In**.
- 2 Choose a check-in message, and select **Send Message**.

Sending a Text Message

- 1 Select .
- 2 Select **inReach** > **Messages** > **New Message**.
- 3 Select an option:
 - To start with a pre-written message, select **Send Quick Text**.
NOTE: You can add and edit quick text messages on the Garmin Explore website.
 - To write a custom message, select **Type Message**.
- 4 Select **To** to choose recipients from your contacts list, or enter each recipient's contact information.
- 5 After you have finished your message, select **Send Message**.

Replying to a Message

- 1 Select .
- 2 Select **inReach** > **Messages**.
- 3 Select a conversation.
- 4 Select **Reply**.
- 5 Select an option:
 - To write a custom message, select **Type Message**.
 - To start with a pre-written message, select **Send Quick Text** and select a message.
- 6 When you have finished your message, select **Send Message**.

Checking for Messages

Your navigator automatically checks for messages every hour. When you send a message, it listens for replies for 10 minutes. When you are using the inReach tracking feature, it checks for messages at your tracking interval. You can manually force a message check by checking for messages, sending a message, or sending a track point. During a message check, your navigator connects to satellites and receives messages waiting to be sent to your device.

NOTE: Your navigator must have a clear view of the sky and be in view of a satellite during the listen interval to receive messages.

- 1 Select .
- 2 Select **inReach** > **inReach Utilities** > **Mail Check** > **Check Mailbox**.

Viewing Message Details

- 1 Select .
- 2 Select **inReach** > **Messages**.
- 3 Select a conversation.
- 4 Select a message.
- 5 Select the information tab.

Navigating to a Message Location

When you receive a message from another device with inReach technology, the message may include location information. For these messages, you can navigate to the location from which the message was sent.



- 1 Select .
- 2 Select **inReach > Messages**.
- 3 Select a conversation.
- 4 Select a message with location information.
- 5 Select the map tab.
- 6 Select **Go**.

Including Location Coordinates in a Message

If you are sending a message to a recipient who may not have internet access, you can include your location coordinates in the message. For example, if your recipient has an older model phone that does not support viewing maps or is outside of a mobile data coverage area and cannot view a web page.

- 1 Select .
- 2 Select **inReach > Messages > New Message > Send Location**.
- 3 Enter one or more recipients.
- 4 If necessary, enter a message.
- 5 Select **Send Message**.

Deleting Messages

- 1 Select .
- 2 Select **inReach > Messages**.
- 3 Select a conversation.
- 4 Select  **> Delete Thread**.

Messages Settings

Select . Select **Setup > Messages**.

Ring Until Read: Sets the navigator to ring until you read a new message. This feature is helpful if you are in a noisy environment.

Notifications: Alerts you to incoming inReach messages.

Show On Map: Displays inReach messages on the map.

inReach Tracking

You can use the tracking feature on your Montana 700i/710i/750i/760i device to record track points and transmit them over the Iridium satellite network at the specified send interval.

Track points appear on the Garmin Explore website.

Starting Tracking

- 1 Select .
- 2 Select **inReach > Tracking > Start Tracking**.
NOTE: Starting the Tracking feature also starts recording your path as an activity.

Stopping Tracking

- 1 Select .
- 2 Select **inReach > Tracking > Stop Tracking**.
NOTE: Stopping tracking also pauses your activity recording.

Sharing Your Tracking Page

You can share a link to a tracking webpage with other people. The system automatically adds text, including link information, to the end of your message.

- 1 Select .
- 2 Select **inReach > Tracking > Share With > OK**.
- 3 Select **To** to choose recipients from your contacts list, or enter each recipient's contact information.
- 4 Select **Send Message**.

inReach Tracking Settings

Select . Select **Setup > Tracking**.

Auto Track: Sets the navigator to start tracking when you turn it on.

Link with Recording: Links the track with the current activity recording.

Moving Interval: Sets the frequency at which the navigator records a track point and transmits it over the satellite network when you are moving. If you are on a professional plan, you can specify the interval when you are stationary.

SOS

WARNING

Before you can use the SOS function, you must have an active satellite subscription. Always test your device outdoors before using it on a trip.

Ensure you have a clear view of the sky when using the SOS function, because this feature requires satellite access to operate properly.

NOTICE

Some jurisdictions regulate or prohibit the use of satellite communications devices. It is the responsibility of the user to know and follow all applicable laws in the jurisdictions where the device is intended to be used.

During an emergency, you can use your Montana 700i/710i/750i/760i device to contact the Garmin ResponseSM center to request help. Pressing the SOS button sends a message to the Garmin Response team, and they notify the appropriate emergency responders of your situation. You can communicate with the Garmin Response team during your emergency while you wait for help to arrive. You should only use the SOS function in a real emergency situation.

Initiating an SOS Rescue

You can initiate an SOS rescue with the device turned on or off if the device has battery power.

- 1 Lift the protective cap ① from the **SOS** button ②.

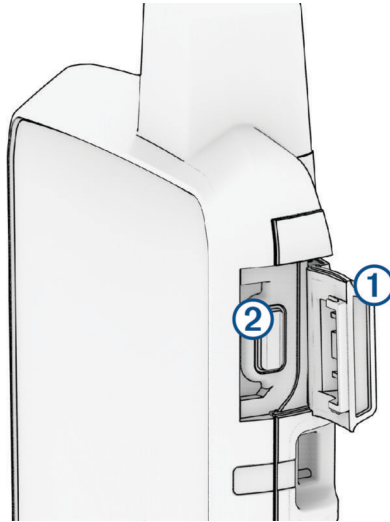

- 2 Press and hold the **SOS** button.

- 3 Wait for the SOS countdown.

The device sends a default message to the emergency response service with details about your location.

- 4 Reply to the confirmation message from the emergency response service.

Your reply lets the emergency response service know that you are capable of interacting with them during the rescue. If you do not reply, the emergency response service will still initiate a rescue.

For the first 10 minutes of your rescue, an updated location is sent to the emergency response service every minute. To conserve battery power after the first 10 minutes, an updated location is sent every 10 minutes.

TIP: You can also initiate an SOS rescue and interact with the Garmin Response team using the Garmin Messenger app. You must have an active satellite subscription to use the SOS feature in the app.

Sending a Custom SOS Message

After pressing the SOS button to initiate an SOS rescue, you can reply with a custom message using the SOS page.

- 1 Select 🏠.
- 2 Select **inReach > SOS > Reply**.
- 3 Select **Type Message** to compose a custom SOS message.
- 4 Select **Send Message**.

Your reply lets the emergency response service know that you are capable of interacting with them during the rescue.

Canceling an SOS Request

If you no longer need assistance, you can cancel an SOS request after it is sent to the emergency response service.

- 1 Lift the protective cap, and hold the **SOS** button.
- 2 Select **Cancel SOS**.
- 3 When prompted to confirm your cancellation request, select **Cancel SOS**.

Your device transmits the cancellation request. When you receive a confirmation message from the emergency response service, the device returns to normal operation.

Sending a Test Message

WARNING

You should send a test message outdoors before using the navigator on a trip to ensure your satellite subscription is active.

- 1 Select .
- 2 Select **inReach > inReach Utilities > Communications Test > Test.**
Wait while the navigator sends a test message. When you receive a confirmation message, your navigator is ready to use.

Syncing inReach Data

After you make changes to your data, such as plan changes, contacts, or check-in messages, you must sync your device using the app.

- 1 Open the paired Garmin Messenger or Garmin Explore app.
- 2 Wait while your data syncs.
TIP: You can check the connection status on the Device tab in the app.

Contacts

You can add, delete, and edit contacts on the Montana 700i/710i/750i/760i device.

Adding a Contact

- 1 Select **inReach > Contacts > New Contact.**
- 2 Select an item to edit.
- 3 Enter the new information.

Editing a Contact

- 1 Select **inReach > Contacts.**
- 2 Select a contact.
- 3 Select an item to edit.
- 4 Enter the new information.



Deleting a Contact

- 1 Select **inReach > Contacts.**
- 2 Select a contact.
- 3 Select  > **Delete Contact.**

Data Use and History



You can view plan details and data use on the Montana 700i/710i/750i/760i device.

Viewing Plan Details

- 1 Select .
- 2 Select **inReach > inReach Utilities.**
- 3 Select .

Viewing Data Use



You can view the number of messages, check-in messages, and track points sent during the current billing cycle. The data use counter resets automatically at the beginning of each billing cycle.

- 1 Select .
- 2 Select **inReach** > **inReach Utilities**.
- 3 Select .



Viewing the Main Pages

The information needed to operate this device is found on the main pages. Default pages include the main menu, map, compass, trip computer, and Where To? pages.

- Select the icons in the **Favorites** bar to scroll through the main pages.
- Hold an icon in the **Favorites** bar, and drag it to a new location to change the order of the icons or remove an icon.

TIP: You can also select **Setup** > **Menus** > **Favorites** to customize the Favorites bar. The  and  icons cannot be removed or changed.



Map

 represents your location on the map. As you travel,  moves and displays your path. Depending on your zoom level, waypoint names and symbols may appear on the map. You can zoom in on the map to see more detail. When you are navigating to a destination, your route is marked with a colored line on the map.

Managing Maps

- 1 Select .
- 2 Select **Setup** > **Map Manager**.
- 3 Select an option:
 - To download premium maps and activate your Outdoor Maps+ subscription for this device, select **Outdoor Maps+** ([Downloading Maps, page 48](#)).
 - To download TopoActive maps, select **TopoActive Maps** ([Downloading TopoActive Maps, page 48](#)).

Navigating with the Map

- 1 Begin navigating to a destination ([Navigating to a Destination, page 22](#)).
- 2 From the map, complete one or more actions:
 - Drag the map to view different areas.
 - Pinch or spread two fingers on the touchscreen to zoom in and out of the map.
 - Select  and  to zoom in and out of the map.
 - Double-tap the map to quickly zoom in.
 - Select a location on the map (represented by a pin), and select the information bar at the top of the screen to view information about the selected location.
 - Select  to select which map layers display on the map.

Map Page Settings

From the map, select .

Stop Navigation: Stops navigating the current route.

Map Setup: Enables you to open additional map settings ([Map Settings, page 15](#)).

Measure Distance: Allows you to measure the distance between multiple locations ([Measuring Distance on the Map, page 15](#)).

Restore Defaults: Restores the map to factory default settings.

Map Settings

From the map, select . Select **Map Setup**.

Map Manager: Shows the downloaded map versions. With an Outdoor Maps+ subscription, allows you to download additional maps ([Downloading Maps, page 48](#)).

Orientation: Adjusts how the map is shown on the page ([Changing the Map Orientation, page 15](#)).

Dashboard: Sets a dashboard to display on the map. Each dashboard shows different information about your route or your location.

NOTE: Your customized settings are remembered by the dashboard. Your settings are not lost when you change profiles ([Profiles, page 59](#)).

Guidance Text: Sets when the guidance text is shown on the map.

Advanced Setup: Allows you to customize advanced map settings ([Advanced Map Settings, page 15](#)).

Advanced Map Settings

From the map, select . Select **Map Setup > Advanced Setup**.

Auto Zoom: Automatically selects the appropriate zoom level for optimal use on your map. When Off is selected, you must zoom in or out manually.

Detail: Sets the amount of detail shown on the map. Showing more detail may cause the map to redraw more slowly.

Vehicle: Sets the position icon, which represents your position on the map. The default icon is a small blue triangle.

Zoom Levels: Adjusts the zoom level at which map items appear. The map items do not appear when the map zoom level is higher than the selected level.

Text Size: Sets the text size for map items.

Map Speed: Adjusts the speed at which the map is drawn. A faster map drawing speed decreases the battery life.

Changing the Map Orientation



- 1 From the map, select .
- 2 Select **Map Setup > Orientation**.
- 3 Select an option:
 - Select **North Up** to show north at the top of the page.
 - Select **Track Up** to show your current direction of travel at the top of the page.
 - Select **Automotive Mode** to show an automotive perspective with the direction of travel at the top.

Measuring Distance on the Map

You can measure the distance between two locations.

- 1 From the map, select a location.
- 2 Select  > **Measure Distance > Start > Use**.
- 3 Move the pin to another location on the map.

Compass

When navigating,  points to your destination, regardless of the direction you are moving. When  points toward the top of the electronic compass, you are traveling directly toward your destination. If  points any other direction, turn until it points toward the top of the compass.

Navigating with the Compass

When navigating to a destination,  points to your destination, regardless of the direction you are moving.

- 1 Begin navigating to a destination ([Navigating to a Destination, page 22](#)).
- 2 From the home screen, select **Compass**.
- 3 Turn until  points toward the top of the compass, and continue moving in that direction to the destination.

Compass Settings

From the compass, select .

Sight 'N Go: Allows you to point the device at an object in the distance, and navigate using the object as a reference point (*Navigating with Sight 'N Go*, page 16).

Stop Navigation: Stops navigation of the current route.

Change Dashboard: Changes the theme and information displayed on the dashboard.

Set Scale: Sets the scale for the distance between the dots on the course deviation indicator when navigating with Sight 'N Go.

Calibrate Compass: Allows you to calibrate the compass if you experience irregular compass behavior, for example, after moving long distances or after extreme temperature changes (*Calibrating the Compass*, page 16).

Heading Setup: Allows you to customize the compass heading settings (*Heading Settings*, page 17).

Lock Data Fields: Locks the data fields. You can unlock the data fields to customize them.

Restore Defaults: Restores the compass to factory default settings.

Navigating with Sight 'N Go



You can point the device at an object in the distance with the compass direction locked in, project the object as a waypoint, and navigate using the object as a reference point.

- 1 From the compass, select  > **Sight 'N Go**.
- 2 Point the device at an object.
- 3 Select **Lock Direction** > **Set Course**.
- 4 Navigate using the compass.

Projecting a Waypoint from Your Current Location

You can save a new waypoint by projecting the distance from your current location.

For example, if you would like to navigate to a location you observe on the other side of a river or stream, you can project a waypoint from your current location to the observed location, and then navigate to the new location after you cross the river or stream.

- 1 From the compass, select  > **Sight 'N Go**.
- 2 Point the device at the new location.
- 3 Select **Lock Direction** > **Project Waypoint**.
- 4 Select a unit of measure.
- 5 Enter the distance, and select .
- 6 Select **Save**.

Calibrating the Compass

Before you can calibrate the electronic compass, you must be outdoors, away from objects that influence magnetic fields, such as cars, buildings, or overhead power lines.

The device has a 3-axis electronic compass. You should calibrate the compass after moving long distances or experiencing temperature changes.

- 1 From the compass, select .
- 2 Select **Calibrate Compass** > **Start**.
- 3 Follow the on-screen instructions.

Heading Settings

From the compass, select  and select **Heading Setup**.

Display: Sets the type of directional heading shown on the compass.

North Reference: Sets the north reference used on the compass.

Go To Line (Pointer): Sets the behavior of the pointer that appears on the map. Bearing points in the direction of your destination. Course (CDI) shows your relationship to the course line leading to the destination.

Compass: Automatically switches from an electronic compass to a GPS compass when you are traveling at a higher rate of speed for a period of time.

Calibrate Compass: Allows you to calibrate the compass if you experience irregular compass behavior, for example, after moving long distances or after extreme temperature changes ([Calibrating the Compass](#), page 16).

Using the Course Pointer





The course pointer is most useful when you are navigating to your destination in a straight line, such as when you are navigating on water. It can help you navigate back to the course line when you go off-course to avoid obstacles or hazards.

1

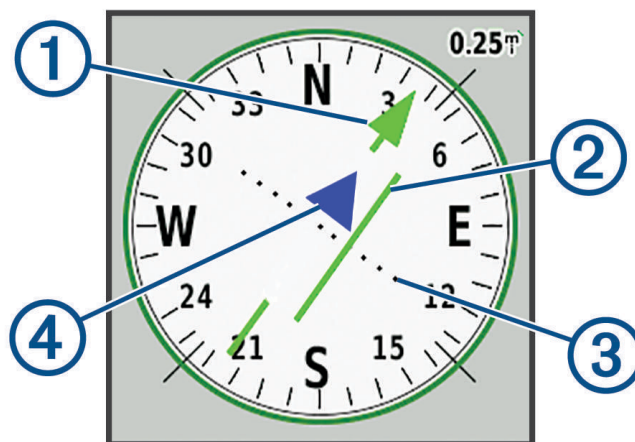
2 Select  to open the options menu.

3 Select **Heading Setup > Go To Line (Pointer) > Course (CDI)** to enable the course pointer.



	Course line pointer. Indicates the direction of the desired course line from your starting point to your next waypoint.
	Course deviation indicator (CDI). Indicates the location of the desired course line in relation to your location. If the CDI is aligned with the course line pointer, you are on course.
	Course deviation distance. The dots indicate your distance off course. The distance represented by each dot is indicated by the scale in the upper-right corner.
	To-and-from indicator. Indicates whether you are past the next waypoint.

Trip Computer

The trip computer displays your current speed, average speed, trip odometer, and other helpful statistics. You can customize the trip computer layout, dashboard, and data fields.

Trip Computer Settings

From the trip computer, select .

Reset: Resets all the trip computer values to zero. For accurate information, reset the trip information before beginning a trip.

Change Dashboard: Changes the theme and information displayed on the dashboard.

NOTE: Your customized settings are remembered by the dashboard. Your settings are not lost when you change profiles ([Profiles, page 59](#)).

Lock Data Fields: Locks the data fields. You can unlock the data fields to customize them.

Insert Page: Inserts an additional page of customizable data fields.

Remove Page: Removes an additional page of customizable data fields.

More Data: Adds additional data fields to the trip computer.

Less Data: Removes data fields from the trip computer.

Restore Defaults: Restores the trip computer to its factory default settings.

Altimeter

By default, the altimeter plot displays the elevation over the distance traveled. You can customize the altimeter settings ([Altimeter Settings, page 18](#)). You can select any point on the plot to view details about that point.

You can customize the favorites bar to add the altimeter page ([Customizing the Favorites Bar, page 58](#)).

Altimeter Plot Settings

From the altimeter, select .

Reset: Resets the altimeter data, including waypoint, track, and trip data.

Altimeter Setup: Enables you to open additional altimeter settings ([Altimeter Settings, page 18](#)).

Restore Defaults: Restores the altimeter to factory default settings.

Altimeter Settings

From the altimeter, select  > **Altimeter Setup**.

Auto Calibration: Once allows the altimeter to automatically calibrate one time when you start an activity. Continuous allows the altimeter to calibrate throughout the duration of your activity.

Barometer Mode: Variable Elevation allows the barometer to measure changes in elevation while you are moving. Fixed Elevation assumes the device is stationary at a fixed elevation, so the barometric pressure should only change due to weather.

Pressure Trending: Sets how the device records pressure data. Save Always records all pressure data, which can be helpful when you are watching for pressure fronts.

Plot Type: Records elevation changes over a period of time or distance, records barometric pressure over a period of time, or records ambient pressure changes over a period of time.

Calibrate Altimeter: Allows you to manually calibrate the barometric altimeter ([Calibrating the Barometric Altimeter, page 18](#)).

Calibrating the Barometric Altimeter

You can manually calibrate the barometric altimeter if you know the correct elevation or the correct barometric pressure.

- 1 Go to a location where the elevation or barometric pressure is known.
- 2 From the altimeter, select  > **Altimeter Setup** > **Calibrate Altimeter**.
- 3 Follow the on-screen instructions.

Connected Features

Connected features are available for your Montana device when you connect the device to a wireless network or a compatible phone using Bluetooth technology. Some features require you to install the Garmin Messenger app on your phone. Some features require you to install the Garmin Explore app on your phone. Go to garmin.com/apps for more information.

Garmin Messenger: The Garmin Messenger app allows you to compose and send messages using your phone, and to sync contacts and check-in messages with your device.

Garmin Explore: The Garmin Explore app syncs and shares waypoints, courses, and collections with your device. You can also download maps to your phone for offline access.

Bluetooth sensors: Allows you to connect Bluetooth compatible sensors, such as a heart rate monitor.

Connect IQ™: Allows you to extend your device features with widgets, data fields, and apps using the Connect IQ app.

EPO Downloads: Allows you to download an extended prediction orbit file to quickly locate GPS satellites and reduce the time it takes to get an initial GPS fix using the Garmin Explore app or when connected to a Wi-Fi network.

Outdoor Maps+: Allows you to download free satellite imagery or premium map data using an Outdoor Maps+ subscription when connected to a Wi-Fi network.

Live Geocache Data: Provides paid or subscription-free services to view live geocache data from www.geocaching.com using the Garmin Explore app or when connected to a Wi-Fi network.

Tracking: Allows you to record track points and transmit them over the Iridium satellite network. You can invite contacts to follow along by sending them an inReach message from the field. This feature allows your contacts to view your live data on a tracking webpage.

Phone notifications: Displays phone notifications and messages on your Montana device using the Garmin Explore app.

Software Updates: Allows you to receive updates for your device software using the Garmin Explore app or when connected to a Wi-Fi network.

Active Weather: Allows you to view current weather conditions and weather forecasts using the Garmin Explore app or when connected to a Wi-Fi network.

inReach Weather: Allows you to receive weather information through your inReach subscription. You can request a weather forecast.

Connected Feature Requirements

Some features require a phone and a Garmin app on your phone.

Feature	Connected to a Paired Phone	Connected to a Wi-Fi Network
Activity uploads to Garmin Connect™	Yes	Yes
Software updates	Yes	Yes
EPO downloads	Yes	Yes
Live geocache data	Yes	Yes
Weather	Yes	Yes
Phone notifications	Yes ¹	No
Connect IQ	Yes	No
Outdoor Maps+	Yes ²	Yes ³

¹ The device receives phone notifications from a paired iOS® phone directly, and through the Garmin Connect app on an Android™ phone.

² Required to activate your subscription.

³ Required to download maps.

Pairing a Smartphone with Your Device

- 1 Bring your compatible smartphone within 10 m (33 ft.) of your device.
- 2 On your compatible smartphone, enable Bluetooth technology, and download and open the Garmin Explore or Garmin Connect app.
- 3 On your Montana device, select **Setup > Pair Phone > Pair**.
- 4 From the app, select the devices option and follow the on-screen instructions to pair your device.

Phone Notifications

Phone notifications require a compatible smartphone to be within Bluetooth range and paired with the device. When your phone receives messages, it sends notifications to your device.

Viewing Phone Notifications

Before you can view notifications, you must pair your device with your compatible phone.

- 1 Press **I** or swipe down from the top of the screen to open the status page.
- 2 Select **Notifications**.
- 3 Select a notification.

Hiding Notifications

Notifications are enabled by default when you pair your device with a compatible phone. You can hide notifications so they do not appear on your device screen.

- 1 Select **Setup > Phone**.
- 2 Select **Notifications** to turn off notifications on the device.

Managing Notifications

You can use your compatible phone to manage notifications that appear on your Montana device.

Select an option:

- If you are using an iPhone®, go to the iOS notifications settings, and select the notifications to show on your phone and device.

NOTE: All notifications that you enable on your iPhone also appear on your device.

- If you are using an Android phone, from the Garmin Connect app, select **••• > Settings > Smart Notifications > App Notifications**, and select the notifications that you want to appear on your device.

Connecting to a Wireless Network

- 1 Select **Setup > Wi-Fi**.
- 2 If necessary, select the toggle switch to enable Wi-Fi technology.
- 3 Select **Add Network**.
- 4 Select an option:
 - To select a broadcast wireless network, select a wireless network from the list and enter the password, if necessary.
 - To select a non-broadcast wireless network, select **≡ > Add Network**, and enter the network SSID and password.

The device stores the network information and connects automatically when you return to this location.

Setting Up Wi-Fi Connectivity

Before you can use Wi-Fi features, you must set up the Wi-Fi connection using the Garmin Express™ application.

- 1 Go to garmin.com/express, and download the Garmin Express application.
- 2 Select the device.
- 3 Select **Tools > Utilities**.
- 4 Follow the on-screen instructions to set up Wi-Fi connectivity with the Garmin Express application.

Connect IQ Features

You can add Connect IQ features to your device from Garmin and other providers using the Connect IQ app. You can customize your device with data fields, widgets, and apps.

Data Fields: Allow you to download new data fields that present sensor, activity, and history data in new ways. You can add Connect IQ data fields to built-in features and pages.

Widgets: Provide information at a glance, including sensor data and notifications.

Apps: Add interactive features to your device, such as new outdoor and fitness activity types.

Downloading Connect IQ Features

Before you can download features from the Connect IQ app, you must pair your Montana device with your smartphone (*Pairing a Smartphone with Your Device*, page 20).

- 1 From the app store on your smartphone, install and open the Connect IQ app.
- 2 If necessary, select your device.
- 3 Select a Connect IQ feature.
- 4 Follow the on-screen instructions.

Downloading Connect IQ Features Using Your Computer

- 1 Connect the device to your computer using a USB cable.
- 2 Go to apps.garmin.com, and sign in.
- 3 Select a Connect IQ feature, and download it.
- 4 Follow the on-screen instructions.

Garmin Explore

The Garmin Explore website and app allow you to create courses, waypoints, and collections, plan trips, sync tracks, upload activities, and use cloud storage. They offer advanced planning both online and offline, allowing you to share and sync data with your compatible Garmin device. You can use the app to download maps for offline access, and then navigate anywhere without using your cellular service.

You can download the Garmin Explore app from the app store on your phone, or you can go to explore.garmin.com.

Wireless Headsets

Your device can send audio navigation prompts to a Bluetooth enabled wireless headset.

Pairing a Wireless Headset with Your Device

Before you can receive navigation prompts through your headset, you must pair your device with a compatible headset with Bluetooth technology.

NOTE: Only one headset can be active at a time.

- 1 Place your headset and your Montana device within 10 m (33 ft.) of each other.
- 2 On your headset, enable Bluetooth technology and make it visible to other Bluetooth devices.
- 3 On your Montana device, select **Setup > Bluetooth Audio > Audio Device > Add Device**.
A list of nearby Bluetooth devices appears.
- 4 Select your headset from the list.

Your device sends navigation prompts to your headset as you navigate a route.

Disconnecting or Removing a Wireless Headset

- 1 Select **Setup** > **Bluetooth Audio** > **Audio Device**.
- 2 Select your headset.
- 3 Select an option:
 - To temporarily disconnect a headset without deleting it from the paired devices list, select **Disconnect Device**.
 - To delete a headset from the paired devices list, select **Remove**.

Navigation



You can use the GPS navigation features on your device to navigate a saved activity, route, or course.

- Your device records your path as an activity. Activities use corridor navigation. When navigating a saved activity, it cannot be recalculated ([Recordings, page 28](#)).
- A route is a sequence of waypoints or locations that leads you to your destination. If you depart from the original route, the device recalculates the route and provides new directions ([Routes, page 26](#)).
- A course can have multiple destinations, and can be created point to point or on routable roads. When navigating a saved course, you can choose to navigate using the direct path with no map adjustments or recalculations, or following roads and trails with recalculations as needed. You can convert saved activities and routes to courses ([Courses, page 32](#)).

Where To? Page

You can use the  page to find a destination to navigate to. Not all Where To? categories are available in all areas and maps.

Navigating to a Destination

- 1 Select .
- 2 Select a category.
- 3 If necessary, select  > **Spell Search**, and enter the destination name or part of the name.
- 4 Select a destination.
- 5 Select **Go**.
- 6 If necessary, select the activity type.
- 7 If necessary, select the route calculation method.
Your route appears as a colored line on the map.
- 8 Navigate using the map ([Navigating with the Map, page 14](#)) or compass ([Navigating with the Compass, page 15](#)).

Stopping Navigation

From the map or compass, select  > **Stop Navigation**.

Finding an Address

You can use the preloaded City Navigator® maps on the Montana 700i/710i/750i/760i device to search for addresses.

You can purchase City Navigator maps for the Montana 700/710 device. See [Optional Maps, page 23](#) for more information.

- 1 Select  > **Addresses**.
- 2 Select **Search Area**, and select an option:
 - Select **Enter City/Postal Code**, and enter the city or postal code.
 - Select **Enter State/Province**, and enter the state or province.
- 3 Select **Number**, and enter the house number.
- 4 Select **Street Name**, and enter the street.

Navigating a Driving Route

Before you can navigate street routes, you must have City Navigator maps or other maps with street routes installed.

- 1 Select **Profile Change > Driving**.
- 2 Select a destination.
- 3 Navigate using the map.

Turns appear in the text bar along the top of the map. Audible tones signal turns in the route.

Optional Maps



You can use additional maps with the device, such as Outdoor Maps+, City Navigator, and Garmin HuntView™ Plus detailed maps. Detailed maps may contain additional points of interest, such as restaurants or marine services. For more information, go to buy.garmin.com or contact your Garmin dealer.

Showing and Hiding Map Data

If you have multiple maps installed on your device, you can choose the map data to show on the map.

- 1 From the map, select .
- 2 Select the map layer to show or hide the map data.

Finding a Location Near Another Location

- 1 Select .
- 2 Select  to open the options menu.
- 3 Select **Search Near**, and select an option.
- 4 Select a location.

Waypoints

Waypoints are locations you record and store in the device. Waypoints can mark where you are, where you are going, or where you have been.

Saving Your Current Location as a Waypoint

- 1 Select **Mark Waypoint**.
- 2 If necessary, select a field to edit information about the waypoint, such as the name or location.
- 3 Select **Save**.

Saving a Location on the Map as a Waypoint

You can save a location on the map as a waypoint.



- 1
- 2 Tap the screen to select a location.
- 3 Select the information bar at the top of the screen.
- 4 Select  to open the options menu.
- 5 Select **Save as Waypoint**.

Navigating to a Waypoint



- 1 Select  > **Waypoints**.
- 2 Select a waypoint.
- 3 Select **Go**.

By default, your route to the waypoint appears as a straight, colored line on the map.

Finding a Saved Waypoint

- 1 Select .
- 2 Select **Waypoint Manager**.
- 3 Select  to open the options menu.
- 4 If necessary, select an option:
 - Select **Spell Search** to search using the name of the waypoint.
 - Select **Select Symbol** to search using the symbol of the waypoint.
 - Select **Search Near** to search near a recently found location, another waypoint, your current location, or a point on the map.
 - Select **Sort** to view the list of waypoints based on nearest distance or alphabetical order.
- 5 Select a waypoint from the list.



Editing a Waypoint

- 1 Select .
- 2 Select **Waypoint Manager**.
- 3 Select a saved waypoint.
- 4 Select an item to edit, such as the name or location.
- 5 Enter the new information, and select .

Deleting a Waypoint

- 1 Select **Waypoint Manager** >  > **Delete**.
- 2 Select an option:
 - To delete one waypoint, select a waypoint.
 - To delete multiple waypoints, select multiple waypoints.
 - To delete all waypoints, select **Select All**.
- 3 Select **Delete**.

Changing the Photo for a Waypoint

- 1 Select .
- 2 Select **Waypoint Manager**.
- 3 Select a waypoint.
- 4 Select  to open the options menu.
- 5 Select **Change Photo**.
- 6 Select a photo.
- 7 Select **Use**.

Increasing the Accuracy of a Waypoint Location





You can refine the accuracy of a waypoint location by averaging the location data. When averaging, the device takes several GPS readings at the same location and uses the average value to provide more accuracy.

- 1 Select **Waypoint Manager**.
- 2 Select a waypoint.
- 3 Select  > **Average Location**.
- 4 Move to the waypoint location.
- 5 Select **Start**.
- 6 Follow the on-screen instructions.
- 7 When the confidence status bar reaches 100%, select **Save**.



For best results, collect four to eight samples for the waypoint, waiting at least 90 minutes between samples.

Projecting a Waypoint from a Saved Waypoint



You can save a new waypoint by projecting the distance and bearing from a saved waypoint to a new location.

- 1 Select .
- 2 Select **Waypoint Manager**.
- 3 Select a waypoint.
- 4 Select  to open the options menu.
- 5 Select **Project Waypoint**.
- 6 Enter the bearing, and select .
- 7 Select a unit of measure.
- 8 Enter the distance, and select .
- 9 Select **Save**.

Moving a Waypoint on the Map

- 1 Select .
- 2 Select **Waypoint Manager**.
- 3 Select a waypoint.
- 4 Select  to open the options menu.
- 5 Select **Move Waypoint**.
- 6 Tap the screen to select a new location on the map.
- 7 Select **Move**.



Finding a Location Near a Waypoint

- 1 Select .
- 2 Select **Waypoint Manager**.
- 3 Select a waypoint.
- 4 Select  to open the options menu.
- 5 Select **Find Near Here**.
- 6 Select a category.

The list displays locations near the selected waypoint.



Setting a Waypoint Proximity Alarm

You can add a proximity alarm for a waypoint. Proximity alarms alert you when you are within a specified range of a particular location.

- 1 Select .
- 2 Select **Waypoint Manager**.
- 3 Select a waypoint.
- 4 Select  to open the options menu.
- 5 Select **Set Proximity**.
- 6 Enter the radius.



When you enter an area with a proximity alarm, the device sounds a tone.

Adding a Waypoint to a Route

- 1 Select .
- 2 Select **Waypoint Manager**.
- 3 Select a waypoint.
- 4 Select  to open the options menu.
- 5 Select **Add to Route**.
- 6 Select a route.

Repositioning a Waypoint to Your Current Location

You can change the position of a waypoint. For example, if you move your vehicle, you can change the location to your current position.

- 1 Select .
- 2 Select **Waypoint Manager**.
- 3 Select a waypoint.
- 4 Select  to open the options menu.
- 5 Select **Reposition Here**.

The waypoint location changes to your current location.



Routes

A route is a sequence of waypoints or locations that leads you to your final destination. Routes are saved as GPX files on the device.

Creating a Route

- 1 Select **Route Planner > Create Route > Add Point**.
- 2 Select a category.
- 3 Select the first point in the route.
- 4 Select **Add**.
- 5 Select **Add Point** to add additional points to the route.
- 6 Select **Done**.
- 7 Edit the route name if necessary, and select  to save the route.

Creating a Route Using the Map

- 1 Select **Route Planner > Create Route > Add Point > Use Map**.
- 2 Select a point on the map.
- 3 Select **Add**.
- 4 Move the map, and select additional points on the map to add to the route.
- 5 Select  **> Done**.
- 6 Edit the route name if necessary, and select  to save the route.

Creating a Round-Trip Route

The device can create a round-trip route based on a specified distance and a starting location.

- 1 Select  > **Round-Trip Routing**.
- 2 Select **Distance**, and enter the total distance for the route.
- 3 Select **Start Location**.
- 4 Select an option:
 - Select **Current Location**.
NOTE: If the device cannot acquire satellite signals to determine your current location, the device prompts you to use the last known location or to select the location on the map.
 - Select **Use Map** to select a location on the map.
- 5 If necessary, select **Activity** to change the activity type for route calculation.
- 6 Select **Search**.
The device creates up to three courses.
TIP: You can select Search again to generate different routes.
- 7 Select a route to view it on the map.
- 8 Select **Go**.

Navigating a Saved Route

- 1 Select .
- 2 Select **Routes**.
- 3 Select a route.
- 4 Select **Go**.
By default, your route appears as a straight, colored line on the map.

Adding Points to a Route

- 1 While navigating a route, select a location on the map.
- 2 Select the information bar at the top of the screen.
- 3 Select **Go**.
- 4 Select an option:
 - To add the point as an intermediate destination in the current route, select **Add as Via Point**.
 - To change the current route destination to the new point, select **Set as New Destination**.

Viewing the Active Route

- 1 Begin navigating a route ([Navigating a Saved Route, page 27](#)).
- 2 Select .
- 3 Select **Active Route**.
You may need to add this application to the home screen before you can select it ([Customizing the Main Menu, page 38](#)).
- 4 Select a point in the route to view additional details.

Editing a Route

- 1 Select **Route Planner**.
- 2 Select a route.
- 3 Select the route name to edit it (optional).
- 4 Select **Edit Route**.
- 5 Select a point.
- 6 Select an option:
 - To view the point on the map, select **Review**.
 - To change the order of the points on the route, select **Move Up** or **Move Down**.
 - To insert an additional point on the route, select **Insert Before**.
The additional point is inserted before the point you are editing.
 - To remove the point from the route, select **Remove**.
- 7 Select **Done** to save the route.

Viewing a Route on the Map

- 1 Select .
- 2 Select **Route Planner**.
- 3 Select a route.
- 4 Select the map tab.



Viewing the Elevation Plot of a Route

The elevation plot displays the elevations for a route based on your route setting. If your navigator is configured for direct routing, the elevation plot displays the straight-line elevations between route points. If your navigator is configured for on-road routing, the elevation plot displays the elevations along the roads included in your route.



- 1 Select .
- 2 Select **Route Planner**.
- 3 Select a route.
- 4 Select the elevation plot tab.

Reversing a Route

You can switch the start and end points of your route to navigate the route in reverse.

- 1 Select .
- 2 Select **Route Planner**.
- 3 Select a route.
- 4 Select  to open the options menu.
- 5 Select **Reverse Route**.

Deleting a Route

- 1 Select .
- 2 Select **Route Planner**.
- 3 Select a route.
- 4 Select  to open the options menu.
- 5 Select **Delete**.

Recordings

Your device records your path as an activity. Activities contain information about points along your recorded path, including time and location for each point. Activities are saved as FIT files on the device.

Recording Settings

Select . Select **Setup > Recording**.

Record Method: Sets the recording method. The Auto option records points at a variable rate to create an optimum representation of your path. You can also record points at specific time or distance intervals.

Interval: Sets the recording rate. Recording points more frequently creates a more-detailed path, but fills the recording log faster.

Auto Pause: Sets the device to stop recording your path when you are not moving.

Auto Start: Sets the device to start a new recording automatically when the previous recording ends.

Activity Type: Sets the default activity type for the device.

Advanced Setup: Allows you to customize additional recording settings ([Advanced Recording Settings, page 29](#)).

Advanced Recording Settings

Select . Select **Setup > Recording > Advanced Setup**.

Output Format: Sets the device to save the recording as a FIT or a GPX and FIT file ([File Types, page 62](#)). The FIT option records your activity with fitness information that is tailored for the Garmin Connect application and can be used for navigation. The FIT and GPX option records your activity as both a traditional track that can be viewed on the map and used for navigation, and as an activity with fitness information.

Auto Save: Sets an automated schedule to save your recordings. This helps organize your trips and save memory space ([Auto Save Settings, page 29](#)).

Trip Recording: Sets a trip recording option.

Recorded Data Reset: Sets a reset option. The Activity and Trip option resets the recording and trip data when you finish the active recording. The Prompted option prompts you to select the data to reset.

Auto Save Settings

Select . Select **Setup > Recording > Advanced Setup > Auto Save**.

When Full: Automatically saves the current recording and starts a new one when the current recording is near 20,000 track points.

Auto: Automatically saves the current recording based on its length and the number of track points taken.

Daily: Automatically saves the previous day's recording and starts a new one when you turn on the device on a new day.

Weekly: Automatically saves the previous week's recording and starts a new one when you turn on the device on a new week.





Never: Never saves the current recording automatically.

When the current recording nears 20,000 track points, the device filters the active track to remove redundant points while retaining the shape and history of the recording. Unfiltered points are saved in a temporary GPX and FIT file that is saved or discarded when the recording stops.

NOTE: When importing FIT activities or GPX tracks with more than 20,000 track points, the device filters the line to fit in the device memory and improve map drawing performance, while retaining the shape and history of the recording. The FIT and GPX files retain all of their original track points.





Viewing the Current Activity

By default, the device automatically starts recording your path as an activity when it is turned on and has acquired satellite signals. You can pause and start recording manually.

- 1 Select  to open the status page.
- 2 Select **Activity Recording**.
- 3 Select an option:
 - To control the current activity recording, select .
 - To view data fields for the activity, select .
 - To view the current activity on the map, select .
 - To view the elevation plot for the current activity, select .



Customizing Your Activity Log

You can customize how your device displays and records activities.





- 1 Select  to open the status page.
- 2 Select **Activity Recording** > .
- 3 Select an option:
 - To change the color of the activity line on the map, select **Color**.
 - To display a line on the map indicating your activity, select **Shown On Map**.
- 4 Select  > **Activities Setup** > **Record Method**.
- 5 Select an option:
 - To record activities at a variable rate that creates an optimum representation of your activities, select **Auto**.
 - To record activities at a specified distance, select **Distance**.
 - To record activities at a specified time, select **Time**.
- 6 Select **Interval**.
- 7 Complete an action:
 - If you selected **Auto** for the **Record Method**, select an option to record activities more or less often.
NOTE: Using the **Most Often** interval provides the most activity detail, but fills up the device memory quicker.
 - If you selected **Distance** or **Time** for the **Record Method**, enter a value, and select .

Navigating Using TracBack



While navigating, you can navigate back to the beginning of your activity. This can be helpful when finding your way back to camp or the trail head.

- 1 Select  to open the status page.
- 2 Select **Activity Recording** >  > **TracBack**.
- 3 Navigate using the map or the compass.

Saving the Current Activity

- 1 Select  to open the status page.
- 2 Select **Activity Recording** > .
- 3 Select an option:
 - Select  to save the entire activity.
 - Select  > **Save Portion**, and select a portion.

Clearing the Current Activity

- 1 Select  to open the status page.
- 2 Select **Activity Recording**.
- 3 Select  >  > **Clear**.

History

History includes date, time, distance, calories, average speed or pace, ascent, descent, and optional wireless sensor information.

NOTE: History is not recorded while the timer is stopped or paused.

When the device memory is full, a message appears. The device does not automatically delete or overwrite your history. You can upload your history to Garmin Connect periodically to keep track of all your activity data ([Using Garmin Connect, page 64](#)).



Viewing Activity Information

- 1 Select **Recorded Activities**.
- 2 Select an activity.
- 3 Select .

Viewing the Elevation Plot of an Activity

- 1 Select **Recorded Activities**.
- 2 Select an activity.
- 3 Select .

Saving a Location from an Activity

- 1 Select **Recorded Activities**.
- 2 Select an activity.
- 3 Select .
- 4 Select a location in the activity.
- 5 Select the location information at the top of the map.
Information about the location appears.
- 6 Select  > **Save as Waypoint**.

Creating a Track from a Saved Activity

You can create a track from a saved activity. This allows you to share your track wirelessly with other compatible Garmin devices.

- 1 Select **Recorded Activities**.
- 2 Select an activity.
- 3 Select  > **Save as Track**.

Reversing an Activity

You can switch the start and end points of your activity to navigate the activity in reverse.

- 1 Select **Recorded Activities**.
- 2 Select an activity.
- 3 Select  > **Copy Reversed**.

Navigating a Saved Activity

- 1 Select  > **Recorded Activities**.
- 2 Select an activity.
- 3 Select **Go**.



Deleting a Saved Activity

- 1 Select **Recorded Activities**.
- 2 Select an activity.
- 3 Select  > **Delete**.



Courses

A course can have multiple destinations, and can be navigated point to point or on routable roads. Courses are saved as FIT files on the device.

Creating a Course

- 1 Select .
- 2 Select **Course Planner > Create Course**.
- 3 Select a course creation method:
 - To create a course with no map adjustments or recalculations, select **Direct Path**.
 - To create a course that adjusts to follow map data and recalculates as needed, select **Roads & Trails**.
- 4 Select **Get Started > Add Point**.
- 5 Select a category.
- 6 Select the first point in the course.
- 7 Select **Add**.
- 8 Select **Add Point** to add additional points to the course.
- 9 Select **Done**.
- 10 Edit the course name if necessary, and select  to save the course.

Creating a Course Using the Map

- 1 Select .
- 2 Select **Course Planner > Create Course**.
- 3 Select a course creation method:
 - To create a course with no map adjustments or recalculations, select **Direct Path**.
 - To create a course that adjusts to follow map data and recalculates as needed, select **Roads & Trails**.
- 4 Select **Get Started > Add Point > Use Map**.
- 5 Select a point on the map.
- 6 Select **Add**.
- 7 Move the map, and select additional points on the map to add to the course.
- 8 Select **Done**.
- 9 Edit the course name if necessary, and select  to save the course.

Navigating a Saved Course

- 1 Select  > **Courses**.
- 2 Select a course.
- 3 Select **Go**.

By default, your route appears as a straight, colored line on the map.

Editing a Course

- 1 Select **Course Planner**.
- 2 Select a course.
- 3 Select a field to edit, such as the name of the course or the course color.
- 4 Select **Edit Course**.
- 5 Select a point.
- 6 Select an option:
 - To view the point on the map, select **Review**.
 - To edit the name of the point, select **Edit Name**.
 - To edit the symbol used to represent the point, select **Edit Icon**.
 - To change the order of the points on the course, select **Move Up** or **Move Down**.
 - To insert an additional point on the course, select **Insert Before**.
The additional point is inserted before the point you are editing.
 - To receive an alert when you arrive at the point, select **Alert on Arrival**.
Points with alerts are generally destinations on your course. Points without alerts are used as shaping points on the course but are not destinations.
 - To remove the point from the course, select **Remove**.
- 7 Select **Done** to save the course.

Viewing a Saved Course on the Map

- 1 Select .
- 2 Select **Course Planner**.
- 3 Select a course.
- 4 Select the map tab.



Viewing the Elevation Plot of a Course

The elevation plot displays the elevations for a course based on your routing settings. If your navigator is configured for direct routing, the elevation plot displays the straight-line elevations between course points. If your navigator is configured for on-road routing, the elevation plot displays the elevations along the roads included in your course.

- 1 Select .
- 2 Select **Course Planner**.
- 3 Select a course.
- 4 Select the elevation plot tab.



Reversing a Course

You can switch the start and end points of your course to navigate the course in reverse.



- 1 Select .
- 2 Select **Course Planner**.
- 3 Select a course.
- 4 Select  to open the options menu.
- 5 Select **Reverse Course**.

Creating a Track or Route from a Saved Course

You can create a track or route from a saved course. The tracks or routes can be navigated using Garmin devices that do not support course navigation.

- 1 Select .
- 2 Select **Course Planner**.
- 3 Select a course.
- 4 Select  to open the options menu.
- 5 Select **Save as Track** or **Save as Route**.

Deleting a Course

- 1 Select .
- 2 Select **Course Planner**.
- 3 Select a course.
- 4 Select  to open the options menu.
- 5 Select **Delete**.

Weather

Active Weather: While your Montana device is connected to your smartphone or to a Wi-Fi network and has an active internet connection, it can receive detailed weather information from the internet. This feature provides hourly and daily forecasts and live graphical weather maps.

inReach Weather: You can receive weather information through your inReach subscription. Your device can send an inReach message to request weather forecasts for your current location or a new location, such as a saved waypoint. Weather forecasts incur data charges or additional charges on your inReach subscription.

Requesting an inReach Weather Forecast

For the best results, you should ensure your navigator has a clear view of the sky when you request an inReach weather forecast.

Your navigator can send a message to request a weather forecast using your inReach subscription. You can receive weather forecasts for your current location, a waypoint, GPS coordinates, or a location you choose on the map. Weather forecasts incur data charges or additional charges on your inReach subscription.

- 1 Select .
- 2 Select **inReach > inReach Weather > New Forecast**.
By default, the navigator requests weather for your current location.
- 3 If necessary, select **Location** to request a weather forecast for an alternate location.
- 4 Select **Get Forecast**.

The navigator sends a request for the forecast. It may take several minutes to receive the weather forecast data.

NOTE: A marine forecast will be included for locations on an ocean or other large body of water, if available. If you are unable to get a marine forecast, select a location further from the shore.

After the navigator finishes downloading the data, you can view the forecast at any time until all the information in the forecast has expired. You can also update the forecast at any time ([Updating an inReach Weather Forecast, page 35](#)).

Updating an inReach Weather Forecast



You can update an inReach weather forecast that has expired or contains outdated information. Updating a forecast incurs the same data charges or additional charges as requesting a forecast.

- 1 Select .
- 2 Select **inReach > inReach Weather**.
- 3 Select a location with an outdated weather forecast.
- 4 Select **Update Forecast > Get Forecast**.

The navigator requests an updated forecast. If you update the My Location forecast, the navigator requests an updated forecast for your current location. It may take several minutes to receive the updated weather forecast data.

Deleting an inReach Weather Forecast

You can delete an expired forecast or a forecast for a location that you no longer need.

- 1 Select .
- 2 Select **inReach > inReach Weather**.
- 3 Select a weather location.
NOTE: You cannot delete the My Location forecast.
- 4 Select  to open the options menu.
- 5 Select **Delete**.





Viewing an Active Weather Forecast

While your Montana navigator is connected to your phone or to a Wi-Fi network and has an active internet connection, it can receive detailed weather information from the internet.





- 1 Select .
- 2 Select **Active Weather**.
The navigator automatically downloads a weather forecast for your current location.
- 3 Select a day to view an hourly forecast, if available.
- 4 Select a time interval to view detailed weather information.

Viewing an Active Weather Map

While your navigator is connected to a phone or Wi-Fi network with internet access, you can view a live weather map showing weather information.

- 1 Select **Active Weather**.
- 2 Select an option:
NOTE: Some options may not be available in all areas.
 - To view the weather forecast for your location, select .
 - To view a weather radar, select .
 - To view cloud coverage, select .
 - To view temperatures, select .
 - To view wind speeds and directions, select .

The selected data appears on the map. The device may take a few moments to load the weather map data.

- 3 Select an option:
 - To zoom in or out on the map, select  or .
 - To view the weather in a time-lapse loop, select .
 - NOTE:** Select  to stop time-lapse mode.
 - To view different areas, drag the map.

Adding an Active Weather Location

You can add a weather location to view active weather for waypoints, GPS coordinates, or other locations.

- 1 View an active weather forecast.
- 2 Select  to open the options menu.
- 3 Select **Manage Locations > New Location**.
- 4 Select a location.

TIP: The Weather Locations option allows you to quickly select a location for which you have previously requested an inReach weather forecast.

- 5 Select **Use**.
 - 6 Edit the location name if necessary, and select .
- The navigator downloads a forecast for the selected location.

Switching the Active Weather Location

You can quickly switch between forecasts for active weather locations you have previously added.

- 1 View an active weather forecast.
- 2 Select  to open the options menu.
- 3 Select **Manage Locations**.
- 4 Select a location from the list.

TIP: The My Location option always downloads a forecast for your current location.

- 5 Select **Use**.
- The navigator downloads the most recent forecast for the selected location.

Deleting an Active Weather Location

- 1 View an active weather forecast.
 - 2 Select  to open the options menu.
 - 3 Select **Manage Locations**.
 - 4 Select a location from the list.
- NOTE:** You cannot delete the My Location forecast.
- 5 Select **Delete**.

Main Menu Applications

Select .

NOTE: Some applications do not appear in the main menu by default. You may need to add applications to the main menu before you can select them ([Customizing the Main Menu, page 38](#)).

Active Route: Displays your active route and all upcoming waypoints ([Routes, page 26](#)).

Active Weather: Displays the current temperature, temperature forecast, weather forecast, weather radar, cloud cover, and wind conditions ([Viewing an Active Weather Forecast, page 35](#)).

Adventures: Displays a list of adventures from the BaseCamp™ application ([Garmin Adventures, page 39](#)).

Alarm Clock: Sets an audible alarm. If you are not currently using the device, you can set the device to turn on at a specific time ([Setting an Alarm, page 40](#)).

Altimeter: Displays the elevation over distance traveled ([Altimeter, page 18](#)).

Area Calculation: Allows you to calculate the size of an area ([Calculating the Size of an Area, page 40](#)).

Calculator: Displays a calculator.

Calendar: Displays a calendar.

Camera: Allows you to take photos with the camera ([Taking a Photo, page 40](#)).

NOTE: The camera is available only on the Montana 750i/760i navigator.

Collections Manager: Displays collections synced from your Garmin Explore account.

Compass: Displays the compass ([Compass, page 15](#)).

Connect IQ: Displays a list of installed Connect IQ apps ([Connect IQ Features, page 21](#)).

Contacts: Allows you to add, edit, and delete contacts for inReach messages ([inReach Features, page 8](#)).

NOTE: inReach features are available only on the Montana 700i/710i/750i/760i navigator.

Course Planner: Displays a list of saved courses and allows you to create new courses ([Courses, page 32](#)).

DogTrack: Allows you to see information transmitted from a handheld dog tracking device on your Montana navigator ([Dog Tracking, page 41](#)).

Flashlight: Turns on the flashlight ([Using the Flashlight, page 43](#)).

Geocaching: Displays a list of downloaded geocaches ([Geocaches, page 43](#)).

Hunt and Fish: Displays the predicted best dates and times for hunting and fishing at your current location.

inReach: Provides access to inReach features, including messaging, SOS, tracking, and inReach Weather ([inReach Features, page 8](#)).

NOTE: inReach features are available only on the Montana 700i/710i/750i/760i navigator.

inReach Remote: Allows you to send messages using your paired inReach satellite communicator ([Using the inReach Remote, page 47](#)).

NOTE: The inReach Remote feature is available only on the Montana 700/710 navigator.

inReach Utilities: Allows you to view details about your inReach subscription, check mail, and test the device ([inReach Features, page 8](#)).

NOTE: inReach features are available only on the Montana 700i/710i/750i/760i navigator.

inReach Weather: Allows you to request weather forecasts using your inReach subscription ([inReach Features, page 8](#)).

NOTE: inReach features are available only on the Montana 700i/710i/750i/760i navigator.

Man Overboard: Allows you to save a man overboard (MOB) location and navigate back to it ([Marking and Starting Navigation to a Man Overboard Location, page 47](#)).

Map: Displays the map ([Map, page 14](#)).

Map Manager: Shows the downloaded map versions and allows you to organize maps into map sets ([Creating Map Sets, page 48](#)). With an Outdoor Maps+ subscription, allows you to download additional maps ([Downloading Maps, page 48](#)).

Mark Waypoint: Saves your current location as a waypoint.

Messages: Allows you to send a check-in or text message over the Iridium satellite network ([inReach Features, page 8](#)).

NOTE: inReach features are available only on the Montana 700i/710i/750i/760i navigator.

Music Control: Allows you to control music on your phone using your paired Montana navigator.

Notifications: Alerts you to incoming calls, texts, social network updates, and more, based on your smartphone notification settings ([Phone Notifications, page 20](#)).

Photo Viewer: Displays saved photos ([Viewing Photos, page 41](#)).

Profile Change: Allows you to change the device profile to customize your settings and data fields for a particular activity or trip ([Selecting a Profile, page 49](#)).

Proximity Alarms: Allows you to set alerts to sound within range of particular locations ([Setting a Proximity Alarm, page 49](#)).

Recorded Activities: Displays your current activity and a list of recorded activities ([Recordings, page 28](#)).

Recording Controls: Allows you to view details about the current activity and control the current activity recording ([Viewing the Current Activity, page 30](#)).

Route Planner: Displays a list of saved routes and allows you to create new routes ([Creating a Route, page 26](#)).

Satellite: Displays your current GPS satellite information ([Satellite Page, page 50](#)).

Saved Tracks: Displays a list of saved tracks ([Creating a Track from a Saved Activity, page 31](#)).

Setup: Allows you to customize the device using the setup menu tools ([Setup Menu, page 52](#)).

Share Wirelessly: Allows you to wirelessly transfer files to another compatible Garmin device ([Sending and Receiving Data Wirelessly, page 50](#)).

Sight 'N Go: Allows you to point the device at an object in the distance, and navigate using the object as a reference point ([Navigating with Sight 'N Go, page 16](#)).

SOS: Allows you to initiate an SOS rescue ([inReach Features, page 8](#)).

NOTE: inReach features are available only on the Montana 700i/710i/750i/760i navigator.

Stopwatch: Allows you to use a timer, mark a lap, and time laps.

Sun and Moon: Displays sunrise and sunset times, along with the moon phase, based on your GPS position.

Trip Computer: Displays the trip computer ([Trip Computer, page 17](#)).

Tracking: Allows you to record track points and transmit them over the Iridium satellite network ([inReach Features, page 8](#)).

NOTE: inReach features are available only on the Montana 700i/710i/750i/760i navigator.

VIRB Remote: Provides camera controls when you have a VIRB® camera paired with your Montana navigator ([Using the VIRB Remote, page 50](#)).

Waypoint Averaging: Allows you to refine a waypoint location for more accuracy ([Increasing the Accuracy of a Waypoint Location, page 24](#)).



Waypoint Manager: Displays all waypoints saved to the device ([Waypoints, page 23](#)).

Where To?: Allows you to find a destination to navigate to ([Where To? Page, page 22](#)).

XERO Locations: Displays laser location information when you have a compatible Xero® device paired with your Montana navigator.

Customizing the Main Menu

You can add, remove, and change the order of items in the main menu.

- Hold any icon in the main menu, and drag it to a new location.
- Hold any icon in the main menu, and drag it to  to remove it from the main menu.
- Select **Add Page**, select a tab, and select an item to add to the main menu.
- Select  > **Change Item Order**, select an item, and follow the on-screen instructions to change the order, add, or remove the item from the main menu.

Customizing and Sharing the Main Menu

You can customize the main menu, save your customization as a new profile, and share the profile with other Montana devices. This allows you to display the same main menu settings on multiple devices. This can be useful if you share multiple devices with other users in your organization.

- 1 Customize the main menu by adding, moving, and deleting items as needed (*Customizing the Main Menu, page 38*).
- 2 Create a new profile (*Creating a Custom Profile, page 59*).
The new profile is created with a default name and number. For example, Profile 10. Your main menu customizations are saved to the new profile.
- 3 Change the name of your new profile to something easily recognizable (*Editing a Profile Name, page 59*).
- 4 Connect the device to your computer using the USB cable (*Connecting the Device to Your Computer, page 63*).
- 5 On your computer, open the file browser, and open the **Garmin > Profiles** folder.
- 6 Copy the .gpf file with the recognizable profile name to your computer.
- 7 Connect the next Montana device to your computer, and copy the .gpf file to the **Garmin > Profiles** folder.
- 8 On the Montana device, select **Profile Change** from the main menu to select the new profile (*Selecting a Profile, page 49*).
- 9 Repeat steps 5 through 8 for each additional Montana device.

Garmin Adventures

You can group related items together as an adventure. For example, you can create an adventure for your latest hiking trip. The adventure could contain the track log of the trip, photos of the trip, and geocaches you hunted. You can use BaseCamp to create and manage your adventures. For more information, go to garmin.com/basecamp.

Sending Files to and from BaseCamp

- 1 Open BaseCamp.
- 2 Connect the device to your computer.
- 3 Select an option:
 - Select an item from a connected device and drag it to My Collection or to a list.
 - Select an item from My Collection or a list and drag it to a connected device.

Creating an Adventure

Before you can create an adventure and send it to your device, you must download BaseCamp to your computer and transfer a track from your device to your computer (*Sending Files to and from BaseCamp, page 39*).

- 1 Open BaseCamp.
- 2 Select **File > New > Garmin Adventure**.
- 3 Select a track, and select **Next**.
- 4 If necessary, add items from BaseCamp.
- 5 Complete the required fields to name and describe the adventure.
- 6 If you want to change the cover photo for the adventure, select **Change**, and select a different photo.
- 7 Select **Finish**.

Starting an Adventure

Before you can start an adventure, you must send an adventure from BaseCamp to your navigator (*Sending Files to and from BaseCamp, page 39*).

When you start a saved adventure, the navigator follows the saved track and displays shortcuts to related information along the track, such as photos and waypoints.

1 Select .

2 Select **Adventures**.

NOTE: You may need to add this application to the main menu before you can select it (*Customizing the Main Menu, page 38*).

3 Select an adventure.

4 Select **Start**.

Setting an Alarm

1 Select **Alarm Clock**.

NOTE: You may need to add this application to the main menu before you can select it (*Customizing the Main Menu, page 38*).

2 Select  and  to set the time.

3 Select **Turn Alarm On > OK**.

The alarm sounds at the selected time. If the device is off at the alarm time, the device turns on and sounds the alarm.

Starting the Countdown Timer

1 Select **Alarm Clock >  > Timer**.

NOTE: You may need to add this application to the main menu before you can select it (*Customizing the Main Menu, page 38*).

2 Select  and  to set the time.

3 Select **Start Timer**.

Calculating the Size of an Area

1 Select .

2 Select **Area Calculation > Start**.

NOTE: You may need to add this application to the main menu before you can select it (*Customizing the Main Menu, page 38*).

3 Walk around the perimeter of the area you want to calculate.

4 Select **Calculate** when finished.

Camera and Photos

You can take photos with your Montana 750i/760i device. If enabled, the geographic location is automatically saved in the photo information. You can navigate to the location.

Taking a Photo

1 Select **Camera**.

2 Turn the device horizontally or vertically to change the orientation of the photo.

3 If necessary, select  to turn on the flash.

TIP: You can select Auto to use the flash only when the camera detects a low-light scene.

4 Select  to take a photo.

Viewing Photos

You can view photos you took with the camera and photos you transferred to the device.

- 1 Select **Photo Viewer**.
- 2 Select a photo.

Sorting Photos

- 1 Select **Photo Viewer** >  > **Sort Photos**.
- 2 Select an option:
 - Select **Most Recently**.
 - Select **Near A Location**, and select a location.
 - Select **On A Specific Date**, and enter a date.

Viewing the Location of a Photo

- 1 Select **Photo Viewer**.
- 2 Select a photo.
- 3 Select  > **View Map**.

Viewing Photo Information

- 1 Select **Photo Viewer**.
- 2 Select a photo.
- 3 Select  > **View Information**.

Navigating to a Photo

- 1 Select **Photo Viewer**.
- 2 Select a photo.
- 3 Select  > **View Information** > **Go**.

Deleting a Photo

- 1 Select **Photo Viewer**.
- 2 Select a photo.
- 3 Select  > **Delete Photo** > **Delete**.

Viewing a Slideshow

- 1 Select **Photo Viewer**.
- 2 Select a photo.
- 3 Select  > **View Slideshow**.

Dog Tracking

The dog tracking features allow you to see information transmitted from your compatible handheld dog tracking device on your Montana device. You can navigate to your dogs, view their current status and location, and view their distance from the handheld device.

Receiving Data From Your Handheld Dog Device

Before you can receive data, you must enable broadcasting on your compatible handheld dog tracking device. See the owner's manual for your handheld dog tracking device for more information.





- 1 Place your handheld dog tracking device within 3 m (10 ft.) of your Montana device.
TIP: Your Montana device receives data from one compatible device at a time. Stay more than 3 m (10 ft.) away from other devices or disable broadcasting on devices from which you do not want to receive data.
- 2 On your Montana device, select **DogTrack**.
NOTE: You may need to add this application to the main menu before you can select it ([Customizing the Main Menu, page 38](#)).
- 3 If necessary, select **Yes** to enable the dog tracking feature.
- 4 Select **Status > Search For New**.
A list of nearby devices appears.
- 5 Select your dog tracking device from the list.
The devices connect and synchronize automatically.

Tracking Your Dogs

- 1 Select **DogTrack**.
The dogs connected to your handheld device appear on the screen.
- 2 Select a dog.
The dog's location and track log appear on the map.
- 3 Select **Go** to navigate to your dog.

Dog Status Icons

Icons on the dog list page indicate the status and location of your dogs.

	Sitting
	Running
	On point
	Treed
	Unknown ⁴

⁴ The unknown status icon indicates the collar has not acquired a satellite signal and the handheld device cannot determine the location of the dog.

Using the Flashlight

WARNING

This device may have a flashlight that can be programmed to flash at various intervals. Consult your physician if you have epilepsy or are sensitive to bright or flashing lights.

NOTE: Using the flashlight can reduce battery life. You can reduce the brightness or flash frequency to extend the life of the battery.

1 Select .

2 Select **Flashlight** > .

NOTE: You may need to add this application to the main menu before you can select it (*Customizing the Main Menu*, page 38).

3 If necessary, use the brightness slider to adjust the brightness.

4 If necessary, select a different flash type.

0	No strobe, constant beam.
1 through 9	Number of strobes per second.
SOS	Emergency strobe. NOTE: Wi-Fi, Bluetooth, and ANT+ connections are disabled in SOS mode.

Geocaches

Geocaching is a treasure hunting activity in which players hide or search for hidden caches using clues and GPS coordinates.

Registering Your Device at Geocaching.com

You can register your device at www.geocaching.com to search for a list of nearby geocaches, or to search live information for millions of geocaches.

1 Connect to a wireless network (*Connecting to a Wireless Network*, page 20) or to the Garmin Connect app (*Pairing a Smartphone with Your Device*, page 20).

2 Select .

3 Select **Setup** > **Geocaching** > **Register Device**.

An activation code appears.

4 Follow the on-screen instructions.

Connecting to Geocaching.com

After you register, you can view geocaches from www.geocaching.com on your device while connected wirelessly.

- Connect to the Garmin Connect app.
- Connect to a Wi-Fi network.

Downloading Geocaches Using a Computer

You can load geocaches manually onto your device using a computer (*Transferring Files to Your Device*, page 64). You can place the geocache files into a GPX file and import them into the GPX folder on the device. With a premium membership to geocaching.com, you can use the "lists" feature to load a large group of geocaches onto your device as a single GPX file.

1 Connect the device to your computer using a USB cable.

2 Go to www.geocaching.com.

3 If necessary, create an account.

4 Sign in.

5 Follow the instructions at geocaching.com to find and download geocaches to your device.

Geocache Searches

You can search the geocaches loaded on your device.

If you are connected to www.geocaching.com, you can search live geocache data and download geocaches.



NOTE: You can download detailed information for more than three geocaches per day with a premium membership. Go to www.geocaching.com for more information.

Searching for a Geocache

You can search the geocaches loaded on your navigator.

If you are connected to www.geocaching.com, you can search live geocache data and download geocaches.

NOTE: You can download detailed information for a limited number of geocaches per day. You can purchase a premium subscription to download more. Go to www.geocaching.com for more information.



- 1 Select .
- 2 Select **Geocaching** > .
- 3 Select  to open the options menu.
- 4 Select an option:
 - To search the geocaches loaded on your navigator by name, select **Spell Search**, and enter a search term.
 - To search for geocaches near you or near another location, select **Search Near**, and select a location.
If you are connected to www.geocaching.com, the search results include live geocache data obtained by **GC Live Download**.
 - To search for live geocaches by code, select **GC Live Download** > **GC Code**, and enter the geocache code.
This feature allows you to download a specific geocache from www.geocaching.com when you know the geocache code.

- 5 Select a geocache.

The geocache details appear.

NOTE: If you selected a live geocache and you are connected, the navigator downloads the full geocache details to the internal storage, if necessary.





Searching for a Geocache on the Map

- 1 Select **Geocaching**.
 - 2 Select .
- If you are connected to www.geocaching.com, you can select  to refresh live geocaches near your location on the map.
- 3 Select  to filter the results (optional).
 - 4 Select a geocache.

The geocache details appear. If you selected a live geocache and you are connected, the device downloads the full geocache details to the internal storage.



Filtering the Geocache List

You can filter your geocache list based on certain factors, such as the level of difficulty.

- 1 Select .
- 2 Select **Geocaching** > .
- 3 Select  to open the options menu.
- 4 Select **Filter**, and select one or more options:
 - To filter by a geocache category, such as puzzle or event, select **Type**.
 - To filter by the physical size of the geocache container, select **Cache Size**.
 - To filter by **Unattempted**, **Did Not Find**, or **Found** geocaches, select **Status**.
 - To filter by the difficulty level of finding the geocache, or the difficulty of the terrain, select a level from 1 to 5.
- 5 Select  to view the filtered geocache list.

Saving a Custom Geocache Filter

You can create and save custom filters for geocaches based on specific factors.

- 1 Select .
- 2 Select **Setup** > **Geocaching** > **Filter Setup** > **Create Filter**.
- 3 Select items to filter.
- 4 Select .

By default, the new filter is saved automatically as Filter followed by a number. For example, Filter 2. You can edit the geocache filter to change the name ([Editing a Custom Geocache Filter, page 45](#)).

Editing a Custom Geocache Filter



- 1 Select .
- 2 Select **Setup** > **Geocaching** > **Filter Setup**.
- 3 Select a filter.
- 4 Select an item to edit.

Applying a Custom Filter to a Geocache List

After you create a filter, you can apply it to the geocache list.

- 1 Select **Geocaching** >  >  >  > **Apply a Saved Filter**.
- 2 Select a filter.

Viewing Geocache Details

- 1 Select .
- 2 Select **Geocaching**.
- 3 Select a geocache.
- 4 Select  to open the options menu.
- 5 Select **Review Point**.
The geocache description and logs appear.

Navigating to a Geocache

- 1 Select .
- 2 Select **Geocaching**.
- 3 Select a geocache.
- 4 Select **Go**.



Using Hints and Clues to find a Geocache

You can use hints or clues, such as a description or coordinates, to help you find a geocache.

- 1 While navigating to a geocache, select **Geocaching**.
- 2 Select an option:
 - To view details about the geocache, select **Description**.
 - To view a clue about a geocache location, select **Hint**.
 - To view latitude and longitude for a geocache, select **Coordinates**.
 - To view feedback about the geocache from previous searchers, select **Logs**.
 - To turn chirp™ searching on, select **chirp**.

Logging the Attempt

After you have attempted to find a geocache, you can log your results. You can verify some geocaches at www.geocaching.com.

- 1 Select .
- 2 Select **Geocaching > Log**.
- 3 Select **Found, Did Not Find, Needs Repair, or Unattempted**.
- 4 Select an option:
 - To stop logging, select .
 - To begin navigation to the geocache nearest you, select **Find Next Closest**.
 - To enter a comment about looking for the cache or about the cache itself, select **Edit Comment**, enter a comment, and select .

If you are signed in to www.geocaching.com, the log uploads to your www.geocaching.com account automatically.

chirp

A chirp is a small Garmin accessory that is programmed and left in a geocache. You can use your device to find a chirp in a geocache.

Enabling chirp Searching

- 1 Select .
- 2 Select **Setup > Geocaching > chirp Setup**.
- 3 Select **chirp Searching > On**.

Finding a Geocache with a chirp

- 1 With chirp searching enabled, navigate to a geocache.

When you are within approximately 10 m (33 ft.) of the geocache that contains a chirp, details about the chirp appear.
- 2 Select **Show Details**.
- 3 If necessary, select **Go** to navigate to the next stage of the geocache.

Removing Live Geocache Data from the Device

You can remove live geocache data to show only geocaches manually loaded on the device using a computer.

- 1 Select .
- 2 Select **Setup > Geocaching > Geocaching Live > Remove Live Data**.

Live geocaching data is removed from the device and no longer appears in the geocache list.



Removing Your Device Registration From Geocaching.com

If you transfer ownership of your device, you can remove your device registration from the geocaching website.

- 1 Select .
- 2 Select **Setup > Geocaching > Geocaching Live > Unregister Device**.

Using the inReach Remote

The inReach remote function allows you to control a compatible inReach satellite communicator using your Montana 700/710 navigator.

- 1 Turn on the inReach satellite communicator.
- 2 On your Montana 700/710 navigator, select **inReach Remote**.
NOTE: You may need to add this application to the main menu before you can select it (*Customizing the Main Menu, page 38*).
- 3 If necessary, select **Yes**.
- 4 Wait while the Montana 700/710 navigator connects to your inReach satellite communicator.
- 5 Select an option:
 - To send a check-in message, select **Send Check-In**, and select a message from the list.
 - To send a text message, select **New Message**, select the message contacts, and enter the message text or select a quick text option.
 - To send an SOS message, select  > **Yes**.
NOTE: You should only use the SOS function in a real emergency situation.
 - To view the timer and distance traveled, select .

Marking and Starting Navigation to a Man Overboard Location

Before you can save a man overboard (MOB) location and navigate back to it, you must add the Man Overboard application (*Customizing the Main Menu, page 38*).

- 1 Select .
- 2 Select **Man Overboard > Start**.
The map opens, showing the route to the MOB location. By default, the route appears as a magenta line.
- 3 Navigate using the map (*Navigating with the Map, page 14*) or compass (*Navigating with the Compass, page 15*).

Downloading Maps

Before you can download maps to your device, you must connect to a wireless network ([Connecting to a Wireless Network, page 20](#)).

- 1 Select **Map Manager > Outdoor Maps+**.

NOTE: You may need to add this application to the main menu before you can select it ([Customizing the Main Menu, page 38](#)).

- 2 Select an option:

- To download free satellite map data without a subscription, select **Add Satellite Imagery**.
- To download premium maps and activate your Outdoor Maps+ subscription for this device, select **Check Subscription > Add**.

NOTE: Go to garmin.com/outdoormaps for information about purchasing a subscription.

- 3 Select  > **Layer Information** to view details about the map layers (optional).



- 4 Select **Add**.

- 5 Select an option:

- Select **Use Map** to download an area directly from the map.
- Select a search area from the available categories.
- Select  > **Search Near** to search for a location near another location.

- 6 Select **Add**.

- 7 From the map, complete one or more actions:

- Drag the map to view different areas.
- Pinch or spread two fingers on the touchscreen to zoom in and out of the map.
- Select  and  to zoom in and out of the map.
- Double-tap the map to quickly zoom in.

- 8 Select the information bar at the top of the screen.

- 9 Select **Name** to edit the name of the map download.

- 10 Select a toggle switch to enable or disable map layers.

An estimated download size appears for the map. You should verify your device has enough available storage space for the map.

TIP: You can tap the name of a map layer for more information about the map data.

- 11 Select  > **Download**.

Downloading TopoActive Maps

Before you can download maps to your device, you must connect to a wireless network ([Connecting to a Wireless Network, page 20](#)).

- 1 Select **Map Manager > TopoActive Maps > Add**.

NOTE: You may need to add this application to the main menu before you can select it ([Customizing the Main Menu, page 38](#)).

- 2 Select a map.

- 3 Select **Download**.

Creating Map Sets

If you have multiple maps installed on your device, you can organize them into map sets and choose which map sets to show on the device.

- 1 Select **Map Manager > Map Sets > Create Map Set**.

- 2 Enter a name for the map set.

- 3 Select maps to add to the map set.

- 4 Select the toggle switch to show or hide the map set.

Editing a Map Set

- 1 Select **Map Manager > Map Sets**.
- 2 Select a map set.
- 3 Select an option:
 - To add or remove maps from the map set, select **Edit**.
 - To change the order of the map sets, select **Move Up** or **Move Down**.
 - To edit the name of the map set, select **Rename**.

Deleting a Map Set

- 1 Select **Map Manager > Map Sets**.
- 2 Select a map set.
- 3 Select **Delete**.

Selecting a Profile

When you change activities, you can change the setup of the device by changing the profile.

- 1 Select .
- 2 Select **Profile Change**.
NOTE: You may need to add this application to the main menu before you can select it ([Customizing the Main Menu, page 38](#)).
- 3 Select a profile.

Setting a Proximity Alarm

Proximity alarms alert you when you are within a specified range of a particular location.

- 1 Select .
- 2 Select **Proximity Alarms > Create Alarm**.
NOTE: You may need to add this application to the main menu before you can select it ([Customizing the Main Menu, page 38](#)).
- 3 Select a category.
- 4 Select a location.
- 5 Select **Use**.
- 6 Enter a radius.

When you enter an area with a proximity alarm, the device sounds a tone.

Editing or Deleting a Proximity Alarm

- 1 Select .
- 2 Select **Proximity Alarms**.
- 3 Select an alarm.
- 4 Select an option:
 - To edit the radius, select **Change Radius**.
 - To view the alarm on a map, select **View Map**.
 - To delete the alarm, select **Delete**.

Setting the Proximity Alarm Tones

You can customize tones for proximity alarms.

- 1 Select **Proximity Alarms >  > Alarm Tones Setup**.
- 2 Select a tone for each audible alarm type.

Disabling All Proximity Alarms

Select **Proximity Alarms** >  > **Disable All Alarms**.

Satellite Page

The satellite page shows your current location, GPS accuracy, satellite locations, and signal strength.

GPS Satellite Settings

Select . Select **Satellite**. Select  to open the options menu.

Use With GPS On: Allows you to turn the GPS on.

Track Up: Indicates whether satellites are shown with their rings oriented with north toward the top of the screen, or oriented with your current track toward the top of the screen.

Single Color: Allows you to select whether the satellite page is displayed in multicolor or single color format.

Set Location On Map: Allows you to mark your current location on the map. You can use this location to create routes or search for saved locations.

AutoLocate Position: Calculates your GPS position using the Garmin AutoLocate® feature.

Satellite Setup: Sets the satellite system options ([Satellite Settings, page 53](#)).

Sending and Receiving Data Wirelessly

Before you can share data wirelessly, you must be within 3 m (10 ft.) of a compatible Garmin device.



Your navigator can send and receive data wirelessly when connected with a compatible Garmin device using ANT+ technology. You can share waypoints, geocaches, routes, tracks, and more.

- 1 Select .
- 2 Select **Share Wirelessly**.
- 3 Select an option:
 - Select **Send**, and select a type of data.
 - Select **Receive** to receive data from another device. The other compatible device must be attempting to send data.
- 4 Follow the on-screen instructions.

Using the VIRB Remote

Before you can use the VIRB remote function, you must enable the remote setting on your VIRB camera. See the *VIRB Series Owner's Manual* for more information.

The VIRB remote function allows you to control your VIRB camera using your navigator.

- 1 Turn on your VIRB camera.
- 2 On your Montana navigator, select **VIRB Remote**.
NOTE: You may need to add this application to the main menu before you can select it ([Customizing the Main Menu, page 38](#)).
- 3 Wait while the navigator connects to your VIRB camera.
- 4 Select an option:
 - To record video, select .
 - To take a photograph, select .



Customizing the Device

Custom Data Fields and Dashboards

Data fields display information about your location or other specified data. Dashboards are a custom grouping of data that can be helpful to a specific or general task, such as geocaching.

Enabling the Map Data Fields

You can show custom data fields on the map.

- 1 From the map, select  > **Map Setup** > **Dashboard**.
- 2 Select **Large Data Field**, **Small Data Fields**, or **Corner Data Fields**.
- 3 If necessary, on the map, select  at the top of the screen to show the data fields.



Customizing the Data Fields

Before you can change the map data fields, you must enable them ([Enabling the Map Data Fields, page 51](#)).

You can customize the data fields and dashboards of the map, compass, trip computer, and altimeter pages.

- 1 From a page that displays data fields, select a data field.
- 2 Select a data field category and a data field.

Customizing Dashboards

- 1 Select a page.
- 2 Select an option:
 - From the map, select  > **Map Setup** > **Dashboard**.
 - From the compass or trip computer, select  > **Change Dashboard**.
- 3 Select a dashboard.

Rotating the Screen

Rotate your device to view in horizontal (landscape) or vertical (portrait) mode.

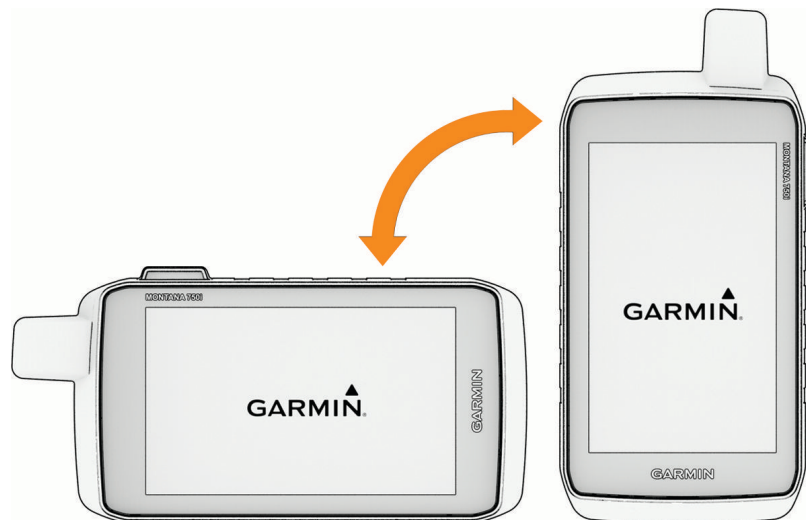

NOTE: While using the inReach features of your Montana 700i/710i/750i/760i device, you should use the device in vertical (portrait) mode, with the antenna pointed toward the sky.

Setup Menu

Select . Select **Setup**.

System: Allows you to customize system settings ([System Settings, page 53](#)).

Display: Adjusts the backlight and display settings ([Display Settings, page 54](#)).

Phone: Allows you to enable Bluetooth technology, pair a phone with your device ([Pairing a Smartphone with Your Device, page 20](#)), and customize phone settings ([Phone Settings, page 54](#)).

Bluetooth Audio: Pairs your device to an audio device ([Bluetooth Audio Settings, page 54](#)).

Wi-Fi: Allows you to connect to wireless networks ([Wi-Fi Settings, page 55](#)).

Tracking: Allows you to customize the inReach tracking settings on your Montana 700i/710i/750i/760i device ([inReach Tracking Settings, page 11](#)).

Messages: Allows you to customize the settings for inReach messages on your Montana 700i/710i/750i/760i device ([Messages Settings, page 10](#)).

Map: Sets the map appearance ([Map Settings, page 15](#)).

Recording: Allows you to customize activity recording settings ([Recording Settings, page 29](#)).

Routing: Allows you to customize how the device calculates routes for each activity ([Routing Settings, page 55](#)).

Expedition Mode: Allows you to customize settings for turning on expedition mode ([Turning On Expedition Mode, page 55](#)).

Waypoints: Allows you to enter a custom prefix for automatically named waypoints.

Tones: Sets the device sounds, such as alarm tones and alerts ([Setting the Device Tones, page 55](#)).

Heading: Allows you to customize the compass heading settings ([Heading Settings, page 17](#)).

Altimeter: Allows you to customize the altimeter settings ([Altimeter Settings, page 18](#)).

Camera: Adjusts the camera settings on your Montana 750i/760i device ([Camera Settings, page 56](#)).

Geocaching: Allows you to customize your geocache settings ([Geocaching Settings, page 56](#)).

Sensors: Pairs wireless sensors with your device ([Sensors Settings, page 56](#)).

Fitness: Allows you to customize settings for recording fitness activities ([Fitness Settings, page 57](#)).

Marine: Sets the appearance of marine data on the map ([Marine Settings, page 57](#)).

Menus: Allows you to customize the device menus ([Menu Settings, page 57](#)).

Position Format: Sets the geographical position format and datum options ([Position Format Settings, page 58](#)).

Units: Sets the units of measure used on the device ([Changing the Units of Measure, page 58](#)).

Time: Adjusts the time settings ([Time Settings, page 58](#)).

Accessibility: Adjusts the accessibility settings ([Accessibility Settings, page 58](#)).

Profiles: Allows you to customize and create new activity profiles ([Profiles, page 59](#)).

Reset: Allows you to reset user data and settings ([Resetting Data and Settings, page 60](#)).

About: Displays device information, such as the unit ID, software version, regulatory information, and license agreement ([Viewing E-label Regulatory and Compliance Information, page 61](#)).

System Settings

Select **Setup > System**.

Satellite: Allows you to adjust the satellite system settings ([Satellite Settings, page 53](#)).

Language: Sets the text language on the device and the language for voice prompts.

NOTE: Changing the text language does not change the language of user-entered data or map data.

Power Key: Allows you to assign shortcuts to the power key ([Customizing the Power Button, page 53](#)).

Advanced Setup: Sets the power mode when connected to or disconnected from external power and sets the communication interface mode ([Interface Settings, page 54](#)).

RINEX Logging: Enables the device to write Receiver Independent Exchange Format (RINEX) data to a system file. RINEX is a data interchange format for raw satellite navigation system data.

Battery Type: Sets the battery type for the Montana 700/710 device.

NOTE: This setting only appears when the optional AA battery pack is installed in the Montana 700/710 device.

Satellite Settings

Select **Setup > System > Satellite**.

Satellite System: Allows you to set the satellite system to GPS, GPS and another satellite system ([GPS and Other Satellite Systems, page 53](#)), or Demo Mode (GPS off).

WAAS/EGNOS: Sets the satellite system to Wide Area Augmentation System/European Geostationary Navigation Overlay Service (WAAS/EGNOS). For more information about WAAS, go to garmin.com/aboutGPS.

GPS and Other Satellite Systems

Using GPS and another satellite system together offers increased performance in challenging environments and faster position acquisition than using GPS only. However, using multiple systems can reduce battery life more quickly than using GPS only.

Your device can use these Global Navigation Satellite Systems (GNSS). Some satellite systems may not be available for all device models.

NOTE: You can view satellite locations and available satellite systems on the satellite page ([Satellite Page, page 50](#)).

GPS: A satellite constellation built by the United States.

GLONASS: A satellite constellation built by Russia.

GALILEO: A satellite constellation built by the European Space Agency.

Customizing the Power Button

You can customize the power button to provide quick access to menus, applications, or other device functions.

- 1 Select **Setup > System > Power Key**.
- 2 Select **Single Tap** or **Double Tap**.
- 3 Select an option.

Interface Settings

Select **Setup > System > Advanced Setup > Interface**.

NOTE: Not all settings are available for all product models.

Garmin Spanner: Allows you to use the device USB port with most NMEA 0183-compliant mapping programs by creating a virtual serial port.

Garmin: Sets the device to use a Garmin proprietary format to exchange waypoint, route, and track data with a computer.

NMEA In/Out: Sets the device to use standard NMEA 0183 output and input.

Text Out: Provides simple ASCII text output of location and velocity information.

MTP: Sets the device to use Media Transfer Protocol (MTP) to access the file system on the device instead of mass storage mode.

NOTE: The Montana 710/710i/760i navigators only support MTP file transfer mode.

Display Settings

Select **Setup > Display**.

Backlight Timeout: Sets the length of time before the backlight turns off.

Orientation Lock: Locks the screen orientation in portrait or landscape mode, or allows the screen to change orientation automatically based on the device orientation.

Auto Lock Screen: Sets the screen to lock automatically.

Battery Save: Saves the battery power and prolongs the battery life by turning off the screen when the backlight times out ([Turning On Battery Save Mode, page 54](#)).

Appearance: Sets the displayed accent colors for day and night ([Appearance Settings, page 54](#)).

Turning On Battery Save Mode

You can use battery save mode to prolong the battery life.

Select **Setup > Display > Battery Save > On**.

In battery save mode, the screen shuts off when the backlight times out. You can select **ⓘ** to turn on the screen, and you can double tap **ⓘ** to view the status page.

Appearance Settings

Select **Setup > Display > Appearance**.

Mode: Sets a light background, a dark background, or automatically switches between the two based on the sunrise and sunset time for your current location.

Day Color: Sets the color for the selections made when in day mode.

Night Color: Sets the color for the selections made when in night mode.

Landscape Controls: Places the controls on the left or right side of the screen when in landscape mode.

Phone Settings

Select . Select **Setup > Phone**.

Status: Enables Bluetooth technology, and shows the current connection status.

Notifications: Shows or hides phone notifications.

Forget Phone: Removes the connected phone. This option is available only after a phone is paired.

Bluetooth Audio Settings

Select . Select **Setup > Bluetooth Audio**.

Audio Device: Allows you to pair a wireless headset with your device ([Pairing a Wireless Headset with Your Device, page 21](#)).

Wi-Fi Settings

Select . Select **Setup > Wi-Fi**.

Wi-Fi: Enables wireless internet technology.

Add Network: Allows you to scan for and connect to a wireless internet network.

Routing Settings

The available routing settings vary based on whether Direct Routing is enabled or disabled.

Select . Select **Setup > Routing**.

Direct Routing: Enables or disables direct routing. Direct routing calculates the most direct route possible to the destination.

Activity: Sets an activity while routing. The navigator calculates routes optimized for the type of activity you are doing.

Course Navigation Method: Sets the method used to calculate courses and routes. The Direct Path option is used for point-to-point navigation without recalculation. The Roads & Trails option adjusts the course to follow map data, recalculating as needed. The Prompted option enables a prompt to select the course navigation method each time you navigate a course.

Course Alerts: Enables or disables course alerts. The navigator alerts you when you go off course, and then alerts you when you navigate back on course.

Popularity Routing: Calculates routes based on the most popular runs and rides from Garmin Connect.

Route Transitions: Sets how the navigator routes from one point on the route to the next. This setting is available only for some activities. The Distance option routes you to the next point on the route when you are within a specified distance of your current point.

Advanced Setup: Allows you to customize additional routing settings ([Advanced Routing Settings, page 55](#)).

Advanced Routing Settings

Select . Select **Setup > Routing > Advanced Setup**.

Lock On Road: Locks the blue triangle, which represents your position on the map, onto the nearest road. This is most useful when driving or navigating on roads.

Calculation Method: Sets the method used to calculate your route.

Off Route Recalculation: Sets recalculation preferences when navigating away from an active route.

Avoidance Setup: Sets the types of roads, terrain, and transportation methods to avoid while navigating.

Turning On Expedition Mode

You can use expedition mode to prolong the battery life. In expedition mode, the screen shuts off, the device enters low power mode, and the device collects fewer GPS track points.

1 Select .

2 Select **Setup > Expedition Mode**.

3 Select an option:

- To enable the device to prompt you to turn on expedition mode when you turn off the device, select **Prompted**.
- To automatically turn on expedition mode after two minutes of inactivity, select **Auto**.
- To never turn on expedition mode, select **Never**.

Setting the Device Tones

You can customize tones for messages, turn warnings, and alarms.

1 Select **Setup > Tones > Tones > On**.

2 Select a tone for each audible type.

Camera Settings

Select **Setup** > **Camera**.

Save Photos To: Sets the photo storage location.

Camera Instructions: Displays brief instructions about taking photos.

Geocaching Settings

Select . Select **Setup** > **Geocaching**.

Geocaching Live: Allows you to remove live geocache data from your device and remove your device registration from geocaching.com (*Removing Live Geocache Data from the Device, page 46, Removing Your Device Registration From Geocaching.com, page 46*).

Geocache Style: Sets the device to display the geocache list using names or codes.

chirp Setup: Allows you to enable chirp searching and program a chirp accessory (*chirp, page 46*).

Filter Setup: Allows you to create and save custom filters for geocaches (*Saving a Custom Geocache Filter, page 45*).

Found Geocaches: Allows you to edit the number of geocaches found. This number automatically increases when you log a find (*Logging the Attempt, page 46*).

Geocache Proximity Alarm: Allows you to set an alert to sound when you are within a specified range of a geocache.

Sensors Settings

Select . Select **Setup** > **Sensors**.

Fitness: Allows you to pair fitness accessories, including a heart rate monitor or speed and cadence sensors.

Tempe Sensor: Allows you to pair a tempe™ temperature sensor.

XERO: Allows you to enable or disable your sharing status and make sharing public or private.

NOTE: You can share your location from a compatible Xero device.

DogTrack: Allows you to receive data from a compatible handheld dog tracking device (*Dog Tracking, page 41*).

Applied Ballistics: You can use Applied Ballistics® devices, such as rangefinders or wind sensors, and view additional ballistics information on your navigator.

inReach Remote: Allows you to enable or disable the inReach remote function and device verification for your Montana 700i/710i/750i/760i device.

NOTE: You can pair a compatible Garmin device and use it to remotely send messages from your Montana 700i/710i/750i/760i device.

Pairing Your Wireless Sensors

Before you can pair, you must put on the heart rate monitor or install the sensor.

Your navigator can be paired with wireless sensors using ANT+ or Bluetooth technology. For example, you can connect a heart rate monitor with your navigator. For more information about compatibility and purchasing optional sensors, go to buy.garmin.com.

1 Bring the navigator within 3 m (10 ft.) of the sensor.

NOTE: Stay 10 m (33 ft.) away from other sensors while pairing.

2 Select .

3 Select **Setup** > **Sensors**.

4 Select your sensor type.

5 Select **Search For New**.

When the sensor is paired with your navigator, the sensor status changes from Searching to Connected.

Fitness Settings

Select . Select **Setup > Fitness**.



Auto Lap: Sets the navigator to automatically mark the lap at a specific distance.

User: Sets your user profile information. The navigator uses this information to calculate accurate training data in Garmin Connect.

HR Zones: Sets the five heart rate zones and your maximum heart rate for fitness activities.

Marking Laps by Distance

You can use the Auto Lap[®] feature to automatically mark the lap at a specific distance. This feature is helpful for comparing your performance over different parts of an activity.

- 1 Select .
- 2 Select **Setup > Fitness > Auto Lap**.
- 3 Enter a value, and select .

Setting Your Fitness User Profile

The device uses information that you enter about yourself to calculate accurate data. You can modify the following user profile information: gender, age, weight, height, and lifetime athlete ([About Lifetime Athletes, page 57](#)).

- 1 Select **Setup > Fitness > User**.
- 2 Modify the settings.

About Lifetime Athletes

A lifetime athlete is an individual who has trained intensely for many years (with the exception of minor injuries) and has a resting heart rate of 60 beats per minute (bpm) or less.

Marine Settings



Select . Select **Setup > Marine**.

Marine Chart Mode: Sets the type of chart the device uses when displaying marine data. Nautical displays various map features in different colors so the marine POIs are more readable and so the map reflects the drawing scheme of paper charts. Fishing (requires marine maps) displays a detailed view of bottom contours and depth soundings and simplifies map presentation for optimal use while fishing.

Appearance: Sets the appearance of marine navigation aids on the map.

Marine Alarm Setup: Sets alarms for when you exceed a specified drift distance while anchored, when you are off course by a specified distance, and when you enter water of a specific depth ([Setting Up Marine Alarms, page 57](#)).

Setting Up Marine Alarms

- 1 Select .
- 2 Select **Setup > Marine > Marine Alarm Setup**.
- 3 Select an alarm type.
- 4 Enter a distance, and select .

Menu Settings

Select . Select **Setup > Menus**.

Menu Style: Changes the appearance of the main menu.

Main Menu: Allows you to move, add, and delete items in the main menu ([Customizing the Main Menu, page 38](#)).

Favorites: Allows you to move, add, and delete the items in the favorites bar ([Customizing the Favorites Bar, page 58](#)).

Setup: Changes the order of items in the setup menu.

Find: Changes the order of items in the find menu.

Customizing the Favorites Bar

You can add, remove, and change the order of items in the favorites bar.

- Hold any icon in the favorites bar, and drag it to a new location.
- Select **Setup > Menus > Favorites**, and select an item to change the order or remove it from the favorites bar.
- To add a new item to the favorites bar, remove an existing item from the favorites bar, and select **Add Page**.

Position Format Settings

NOTE: You should not change the position format or the map datum coordinate system unless you are using a map or chart that specifies a different position format.

Select . Select **Setup > Position Format**.

Position Format: Sets the position format in which a location reading appears.

Map Datum: Sets the coordinate system on which the map is structured.

Map Spheroid: Shows the coordinate system the device is using. The default coordinate system is WGS 84.

Changing the Units of Measure

- 1 Select .
- 2 Select **Setup > Units**.
- 3 Select an option:
 - To change the unit of measure for speed and distance, select **Speed/Distance**.
 - To change the unit of measure for vertical speed, select **Vertical Speed**.
 - To change the unit of measure for elevation, select **Elevation > Elevation**.
 - To change the unit of measure for depth, select **Elevation > Depth**.
 - To change the unit of measure for temperature, select **Temperature**.
 - To change the unit of measure for pressure, select **Pressure**.
- 4 Select a unit of measure.

Time Settings

Select . Select **Setup > Time**.

Time Format: Sets the device to show time in a 12-hour or 24-hour format.

Time Zone: Sets the time zone for the device. The Automatic option sets the time zone automatically based on your GPS position.

Daylight Saving Time: Sets the device to use daylight saving time.

Accessibility Settings

Select **Setup > Accessibility**.

Touch Sensitivity: Sets the touchscreen sensitivity (*Setting the Touchscreen Sensitivity, page 58*).

Review Text Size: Adjusts the size of the text.

Scroll Controls: Adds scroll arrows to the screen when a menu, list, or grid is scrollable.

Setting the Touchscreen Sensitivity

You can adjust the touchscreen sensitivity to suit your activity.

- 1 Select **Setup > Accessibility > Touch Sensitivity**.
- 2 Select an option.

TIP: You can test the touchscreen settings with and without gloves based on your activity.

Profiles

Profiles are a collection of settings that optimize your device based on how you are using it. For example, the settings and views are different when you use the device for hunting than when geocaching.

When you are using a profile and you change settings, such as data fields or units of measurement, the changes are saved automatically as part of the profile.

Creating a Custom Profile

If none of the preloaded profiles fit the needs of your activity or trip, you can create a custom profile with its own unique settings and data fields.

1 Select .

2 Select **Setup > Profiles > Create Profile > OK**.

The new profile is created with a default name and number. For example, Profile 10. The new profile becomes the active profile.

3 Select the new profile.

4 Select an option:

- Customize the default profile name ([Editing a Profile Name, page 59](#)).
- Customize your settings as necessary ([Setup Menu, page 52](#)).
- Customize the data fields as necessary ([Customizing the Data Fields, page 51](#)).

Any changes you make to the settings and data fields are automatically saved to the active profile.

Editing a Profile Name

1 Select .

2 Select **Setup > Profiles**.

3 Select a profile.

4 Select **Edit Name**.

5 Enter the new name.

Deleting a Profile

NOTE: You cannot delete a profile while it is in use.

1 Select .

2 Select **Setup > Profiles**.

3 Select a profile.

4 Select **Delete**.

Setting the Mount Profiles

You can assign a profile to be used for each of the mounting options.

1 Select **Setup > Profiles >  > Set Mount Profiles**.

2 Select a mounting option.

3 Select a profile.

Resetting Data and Settings

- 1 Select .
- 2 Select **Setup > Reset**.
- 3 Select an option:
 - To reset data specific to a trip, such as distance and averages, select **Reset Trip Data**.
 - To delete all saved waypoints, select **Delete All Waypoints**.
 - To clear the data recorded since you started your current activity, select **Clear Current Activity**.
NOTE: The device continues to record new data for the current activity.
 - To reset only the settings for your current activity profile to the factory default values, select **Reset Profile Settings**.
 - To reset all device settings and profiles to the factory default values, select **Reset All Settings**.
NOTE: Resetting all settings clears all geocaching activity from your device. It does not remove your saved user data, such as tracks and waypoints.
 - To remove all saved user data and reset all settings on the device to the factory default values, select **Delete All**.
NOTE: Deleting all settings removes your personal data, history, and saved user data, including tracks and waypoints.

Restoring Default Page Settings

- 1 Open a page for which you will restore the settings.
- 2 Select  > **Restore Defaults**.

Device Information

Product Updates

On your computer, install Garmin Express (www.garmin.com/express). On your smartphone, you can install the Garmin Explore app to upload your waypoints, routes, tracks, and activities.

Garmin Express provides easy access to these services for Garmin devices:

- Software updates
- Map updates
- Product registration

Setting Up Garmin Express

- 1 Connect the device to your computer using a USB cable.
- 2 Go to garmin.com/express.
- 3 Follow the on-screen instructions.

Getting More Information

You can find more information about this product on the Garmin website.

- Go to support.garmin.com for additional manuals, articles, and software updates.
- Go to buy.garmin.com, or contact your Garmin dealer for information about optional accessories and replacement parts.

Viewing E-label Regulatory and Compliance Information

The label for this device is provided electronically. The e-label may provide regulatory information, such as identification numbers provided by the FCC or regional compliance markings, the IMEI number, as well as applicable product and licensing information.

- 1 Select .
- 2 Select **Setup**.
- 3 Select **About**.

Installing AA Batteries

Instead of the included lithium-ion battery pack (*Installing the Lithium-ion Battery, page 4*), you can use three AA batteries with an optional AA battery pack (not included). This is useful when you are on the trail and cannot charge the lithium-ion battery pack. Garmin recommends lithium AA batteries for best results.

NOTE: The optional AA battery pack is compatible with the Montana 700/710 device only.

- 1 Turn the D-ring counterclockwise to remove the lithium-ion battery pack from the Montana 700/710 device.
- 2 Slide the latch to open the AA battery pack.

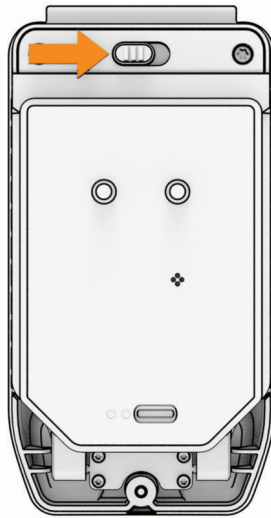

- 3 Insert three AA batteries, observing polarity, and close the battery pack.

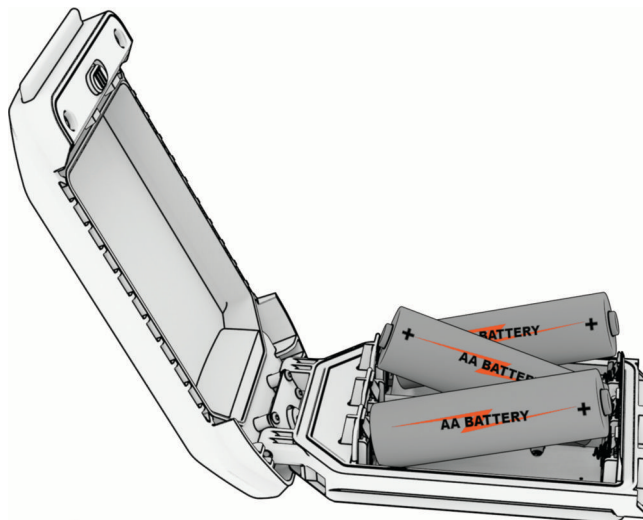

- 4 Insert the AA battery pack into the back of the device, turn the D-ring clockwise, and press the D-ring flat against the back of the device.
- 5 Hold .

- 6 Select **Setup > System > Battery Type**.
- 7 Select **Alkaline, Lithium, NiMH, or Precharged NiMH**.

NOTICE

To prevent corrosion, remove the batteries from the battery pack when not in use, and store the battery pack in a dry location.

Device Care

NOTICE

Do not store the device where prolonged exposure to extreme temperatures can occur, because it can cause permanent damage.

Never use a hard or sharp object to operate the touchscreen, or damage may result.

Avoid chemical cleaners, solvents, sunscreen, and insect repellents that can damage plastic components and finishes.

Secure the weather cap tightly to prevent damage to the USB port.

Secure the weather cap tightly to prevent damage to the external antenna port.

Avoid extreme shock and harsh treatment, because it can degrade the life of the product.

Cleaning the Device

- 1 Wipe the device using a cloth dampened with a mild detergent solution.
- 2 Wipe it dry.

After cleaning, allow the device to dry completely.

Cleaning the USB Port

- 1 Turn off the device and disconnect the device from power.
- 2 Clean the USB port using a soft, clean, lint-free cloth or cotton swab.
NOTE: If necessary, you can lightly dampen the cloth or cotton swab with isopropyl alcohol.
- 3 Allow the device to dry completely before you connect it to power.

Cleaning the Touchscreen

- 1 Use a soft, clean, lint-free cloth.
- 2 If necessary, lightly dampen the cloth with water.
- 3 If using a dampened cloth, turn off the device and disconnect the device from power.
- 4 Gently wipe the screen with the cloth.

Data Management

NOTE: The device is not compatible with Windows® 95, 98, Me, Windows NT®, and Mac® OS 10.3 and earlier.

File Types

The handheld device supports these file types:

- Files from Garmin Explore.
- GPX route, track, and waypoint files.
- GPX geocache files (*Downloading Geocaches Using a Computer, page 43*).
- FIT courses, activities, and locations (waypoints).
- JPEG photo files.
- GPI custom POI files from the Garmin POI Loader. Go to www.garmin.com/products/poiloader.

Installing a Memory Card

⚠ WARNING

Do not use a sharp object to remove user-replaceable batteries.

You can install a microSD memory card, up to 32 GB, in the handheld device for additional storage or pre-loaded maps.

- 1 Turn the D-ring counter-clockwise, and pull up to remove the battery pack.
- 2 Slide the card holder ① to  and lift up.
- 3 Place the memory card with the gold contacts facing down.

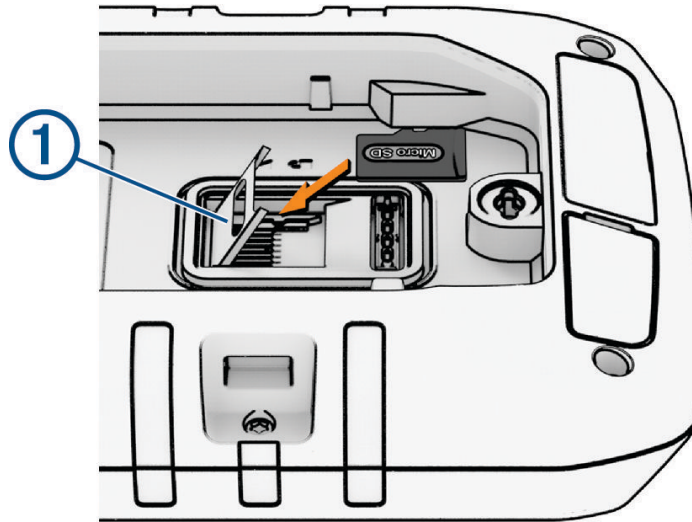

- 4 Close the card holder.
- 5 Slide the card holder to  to lock it.
- 6 Replace the battery pack.

Connecting the Device to Your Computer

NOTICE

To prevent corrosion, thoroughly dry the USB port, the weather cap, and the surrounding area before charging or connecting to a computer.

- 1 Pull up the weather cap from the USB port.
- 2 Plug one end of the cable into the USB port on the device.
- 3 Plug the other end of the cable into a computer USB port.

Your device and memory card (optional) appear as removable drives in My Computer on Windows computers and as mounted volumes on Mac computers.

Transferring Files to Your Device

- 1 Connect the device to your computer.

On Windows computers, the device appears as a removable drive or a portable device, and the memory card may appear as a second removable drive. On Mac computers, the device and memory card appear as mounted volumes.

NOTE: Some computers with multiple network drives may not display device drives properly. See your operating system documentation to learn how to map the drive.

- 2 On your computer, open the file browser.
- 3 Select a file.
- 4 Select **Edit > Copy**.
- 5 Open the portable device, drive, or volume for the device or memory card.
- 6 Browse to a folder.
- 7 Select **Edit > Paste**.

The file appears in the list of files in the device memory or on the memory card.

Deleting Files

NOTICE

If you do not know the purpose of a file, do not delete it. Your device memory contains important system files that should not be deleted.

- 1 Open the **Garmin** drive or volume.
- 2 If necessary, open a folder or volume.
- 3 Select a file.
- 4 Press the **Delete** key on your keyboard.

Using Garmin Connect

- 1 Connect the device to your computer using the USB cable.
- 2 Go to connect.garmin.com.
- 3 Follow the on-screen instructions.

Disconnecting the USB Cable

If your device is connected to your computer as a removable drive or volume, you must safely disconnect your device from your computer to avoid data loss. If your device is connected to your Windows computer as a portable device, it is not necessary to safely disconnect the device.

- 1 Complete an action:
 - For Windows computers, select the **Safely Remove Hardware** icon in the system tray, and select your device.
 - For Apple® computers, select the device, and select **File > Eject**.
- 2 Disconnect the cable from your computer.

Specifications

Montana 700i/710i/750i/760i battery type	Rechargeable lithium-ion battery
Montana 700/710 battery type	Rechargeable lithium-ion battery or three AA batteries (NiMH, alkaline, or lithium). Lithium recommended. NOTE: The optional AA battery pack is not included.
Montana 710i/760i battery life	Up to 24 hr. in GPS mode, with a text message or location sent every 10 min. Up to 432 hr. in expedition mode Up to 384 hr. in expedition mode, with a text message or location sent every 30 min. Up to 1 yr. when powered off NOTE: Battery life estimates are with full sky view and can be significantly impacted by obstructions or tree cover.
Montana 700i/750i battery life	Up to 18 hr. in GPS mode, with a text message or location sent every 10 min. Up to 330 hr. in expedition mode, with a text message or location sent every 30 min. Up to 1 yr. when powered off NOTE: Battery life estimates are with full sky view and can be significantly impacted by obstructions or tree cover.
Montana 700/710 battery life	Up to 18 hr. in GPS mode Up to 330 hr. in expedition mode Up to 1 yr. when powered off NOTE: Battery life estimates are with full sky view and can be significantly impacted by obstructions or tree cover.
Water rating	IEC 60529 IPX7 ⁵
Operating temperature range	From -20° to 60°C (from -4° to 140°F)
Montana 710/710i/760i charging temperature range	From -20° to 0°C (from -4° to 32°F) - Slow charging to full capacity From 0° to 45°C (from 32° to 113°F) - Full speed charging to full capacity From 45° to 60°C (from 113° to 140°F) - Full speed charging to reduced capacity (about 85%)
Montana 700/700i/750i charging temperature range	From 0° to 45°C (from 32° to 113°F) - Full speed charging to full capacity
Compass-safe distance	60 mm (2.36 in.)
Wireless frequencies	2.4 GHz @ 16.91 dBm nominal 1.6 GHz @ 31.7 dBm nominal
EU SAR	0.35 W/kg maximum 1.04 W/kg simultaneous

⁵ The device withstands incidental exposure to water of up to 1 m for up to 30 min. For more information, go to www.garmin.com/waterrating.

Appendix

Data Fields

Some data fields require you to be navigating or require wireless accessories to display data.

24 hr. Max. Temperature: The maximum temperature recorded in the last 24 hours from a compatible temperature sensor.

24 hr. Min. Temperature: The minimum temperature recorded in the last 24 hours from a compatible temperature sensor.

Accuracy of GPS: The margin of error for your exact location. For example, your GPS location is accurate to within +/- 3.65 m (12 ft.).

Activity Distance: The distance traveled for the current track or activity.

Alarm Timer: The current time of the countdown timer.

Ambient Pressure: The uncalibrated ambient pressure.

Ascent - Average: The average vertical distance of ascent since the last reset.

Ascent - Maximum: The maximum rate of ascent in feet per minute or meters per minute since the last reset.

Ascent - Total: The total elevation distance ascended during the activity or since the last reset.

Automotive Turn: The direction of the next turn in the route. You must be navigating for this data to appear.

Average Cadence: Cycling. The average cadence for the current activity.

Average HR %Max.: The average percentage of maximum heart rate for the current activity.

Average Lap: The average lap time for the current activity.

Avg. HR: The average heart rate for the current activity.

Barometer: The calibrated current pressure.

Battery Level: The remaining battery power.

Bearing: The direction from your current location to a destination. You must be navigating for this data to appear.

Cadence: Cycling. The number of revolutions of the crank arm. Your device must be connected to a cadence accessory for this data to appear.

Calories: The amount of total calories burned.

Compass Heading: The direction you are moving based on the compass.

Course: The direction from your starting location to a destination. Course can be viewed as a planned or set route. You must be navigating for this data to appear.

Current Lap: The stopwatch time for the current lap.

Date: The current day, month, and year.

Depth: The depth of the water. Your device must be connected to a NMEA® 0183 device capable of acquiring the water depth.

Descent - Average: The average vertical distance of descent since the last reset.

Descent - Maximum: The maximum rate of descent in meters per minute or feet per minute since the last reset.

Descent - Total: The total elevation distance descended during the activity or since the last reset.

Distance to Dest.: The remaining distance to the final destination. You must be navigating for this data to appear.

Distance to Next: The remaining distance to the next waypoint on the route. You must be navigating for this data to appear.

Elapsed Activity Time: The total time recorded. For example, if you start the timer and run for 10 minutes, then stop the timer for 5 minutes, then start the timer and run for 20 minutes, your elapsed time is 35 minutes.

Elevation: The altitude of your current location above or below sea level.

Elevation Above Ground: The altitude of your current location above ground level.

Elevation - Maximum: The highest elevation reached since the last reset.

Elevation - Minimum: The lowest elevation reached since the last reset.

ETA at Destination: The estimated time of day when you will reach the final destination (adjusted to the local time of the destination). You must be navigating for this data to appear.

ETA at Next: The estimated time of day when you will reach the next waypoint on the route (adjusted to the local time of the waypoint). You must be navigating for this data to appear.

Glide Ratio: The ratio of horizontal distance traveled to the change in vertical distance.

Glide Ratio to Dest.: The glide ratio required to descend from your current position to the destination elevation. You must be navigating for this data to appear.

GPS Elevation: The altitude of your current location using GPS.

GPS Heading: The direction you are moving based on GPS.

GPS Signal Strength: The strength of the GPS satellite signal.

Grade: The calculation of rise (elevation) over run (distance). For example, if you climb 3 m (10 ft.) for every 60 m (200 ft.) you travel, the grade is 5%.

Heading: The direction you are moving.

Heart Rate: Your heart rate in beats per minute (bpm). Your device must be connected to a compatible heart rate monitor.

Heart Rate - %Max.: The percentage of maximum heart rate.

Heart Rate Zone: The performance zone of your current heart rate (1 to 5). The default zones are based on your user profile and maximum heart rate (220 minus your age).

Lap Ascent: The vertical distance of ascent for the current lap.

Lap Cadence: Cycling. The average cadence for the current lap.

Lap Descent: The vertical distance of descent for the current lap.

Lap Distance: The distance traveled for the current lap.

Lap Heart Rate Percent: The average percentage of maximum heart rate for the current lap.

Lap HR: The average heart rate for the current lap.

Laps: The number of laps completed for the current activity.

Lap Speed: The average speed for the current lap.

Last Lap Ascent: The vertical distance of ascent for the last completed lap.

Last Lap Cadence: Cycling. The average cadence for the last completed lap.

Last Lap Descent: The vertical distance of descent for the last completed lap.

Last Lap Distance: The distance traveled for the last completed lap.

Last Lap HR: The average heart rate for the last completed lap.

Last Lap Speed: The average speed for the last completed lap.

Last Lap Time: The stopwatch time for the last completed lap.

Location (lat/lon): The current position in latitude and longitude, regardless of the selected position format setting.

Location (selected): The current position using the selected position format setting.

Location of Dest.: The position of your final destination. You must be navigating for this data to appear.

None: This is a blank data field.

Odometer: A running tally of the distance traveled for all trips. This total does not clear when resetting the trip data.

Off Course: The distance to the left or right by which you have strayed from the original path of travel. You must be navigating for this data to appear.

Pointer: An arrow points in the direction of the next waypoint or turn. You must be navigating for this data to appear.

Speed: The current rate of travel.

Speed Limit: The reported speed limit for the road. Not available in all maps and in all areas. Always rely on posted road signs for actual speed limits.

Speed - Maximum: The highest speed reached since the last reset.

Speed - Moving Avg.: The average speed while moving since the last reset.

Speed - Overall Avg.: The average speed while moving and stopped since the last reset.

Stopwatch Timer: The stopwatch time for the current activity.

Sunrise: The time of sunrise based on your GPS position.

Sunrise/Sunset: The time of the next sunrise or sunset based on your GPS position.

Sunset: The time of sunset based on your GPS position.

Temperature: The temperature of the air. Your body temperature affects the temperature sensor. Your device must be connected to a tempe sensor for this data to appear.

Temperature - Water: The temperature of the water. Your device must be connected to a NMEA 0183 device capable of acquiring the water temperature.

Time of Day: The time of day based on your current location and time settings (format, time zone, daylight saving time).

Time to Destination: The estimated time remaining before you reach the destination. You must be navigating for this data to appear.

Time to Next: The estimated time remaining before you reach the next waypoint in the route. You must be navigating for this data to appear.

To Course: The direction in which you must move to get back on the route. You must be navigating for this data to appear.

Total Lap: The stopwatch time for all the completed laps.

Trip Odometer: A running tally of the distance traveled since the last reset.

Trip Time: A running tally of the total time spent moving and not moving since the last reset.

Trip Time - Moving: A running tally of the time spent moving since the last reset.

Trip Time - Stopped: A running tally of the time spent not moving since the last reset.

Turn: The angle of difference (in degrees) between the bearing to your destination and your current course. L means turn left. R means turn right. You must be navigating for this data to appear.

Velocity Made Good: The speed at which you are closing on a destination along a route. You must be navigating for this data to appear.

Vertical Dist. to Dest.: The elevation distance between your current position and the final destination. You must be navigating for this data to appear.

Vertical Dist. to Next: The elevation distance between your current position and the next waypoint in the route. You must be navigating for this data to appear.

Vertical Speed: The rate of ascent or descent over time.

Vertical Speed to Dest.: The rate of ascent or descent to a predetermined altitude. You must be navigating for this data to appear.

Waypoint at Dest.: The last point on the route to the destination. You must be navigating for this data to appear.

Waypoint at Next: The next point on the route. You must be navigating for this data to appear.

Optional Accessories

Optional accessories, such as mounts, maps, fitness accessories, and replacement parts, are available at <http://buy.garmin.com> or from your Garmin dealer.

tempe

Your device is compatible with the tempe temperature sensor. You can attach the sensor to a secure strap or loop where it is exposed to ambient air, so it provides a consistent source of accurate temperature data. You must pair the tempe sensor with your device to display temperature data. See the instructions for your tempe sensor for more information (garmin.com/manuals/tempe).

Tips for Pairing Wireless Sensors

- Verify that the sensor is compatible with your Garmin device.
- Before you pair the sensor with your Garmin device, move 10 m (33 ft.) away from other sensors with ANT+ technology.
- Bring the Garmin device within range 3 m (10 ft.) of the sensor.
- After you pair the first time, your Garmin device automatically recognizes the sensor each time it is activated. This process occurs automatically when you turn on the Garmin device and only takes a few seconds when the sensors are activated and functioning correctly.
- When paired, your Garmin device receives data from only your sensor, and you can go near other sensors.

Troubleshooting

Maximizing Battery Life

You can do several things to extend the life of the batteries.

- Turn off the screen (*Using the Power Button, page 6*).
- Reduce the backlight brightness (*Adjusting the Backlight, page 6*).
- Reduce the backlight timeout (*Display Settings, page 54*).
- Reduce the flashlight brightness or flash frequency (*Using the Flashlight, page 43*).
- Turn off the screen automatically when the backlight times out (*Turning On Battery Save Mode, page 54*).
- Use expedition mode (*Turning On Expedition Mode, page 55*).
- Turn off wireless connectivity (*Wi-Fi Settings, page 55*).
- Turn off Bluetooth technology (*Bluetooth Audio Settings, page 54*).
- Turn off additional satellite systems (*GPS and Other Satellite Systems, page 53*).



Restarting the Device

If the device stops responding, you may need to restart it. This does not erase any of your data or settings.

- 1 Remove the batteries.
- 2 Reinstall the batteries.
- 3 Hold .

My device is in the wrong language

You can change the device language selection if you have accidentally selected the wrong language on the device.

- 1 Select .
- 2 Select .
- 3 Select .
- 4 Select the second item in the list.
- 5 Select the first item in the list.
- 6 Select your language.

About Heart Rate Zones

Many athletes use heart rate zones to measure and increase their cardiovascular strength and improve their level of fitness. A heart rate zone is a set range of heartbeats per minute. The five commonly accepted heart rate zones are numbered from 1 to 5 according to increasing intensity. Generally, heart rate zones are calculated based on percentages of your maximum heart rate.

Fitness Goals

Knowing your heart rate zones can help you measure and improve your fitness by understanding and applying these principles.

- Your heart rate is a good measure of exercise intensity.
- Training in certain heart rate zones can help you improve cardiovascular capacity and strength.

If you know your maximum heart rate, you can use the table ([Heart Rate Zone Calculations, page 70](#)) to determine the best heart rate zone for your fitness objectives.

If you do not know your maximum heart rate, use one of the calculators available on the Internet. Some gyms and health centers can provide a test that measures maximum heart rate. The default maximum heart rate is 220 minus your age.

Heart Rate Zone Calculations

Zone	% of Maximum Heart Rate	Perceived Exertion	Benefits
1	50–60%	Relaxed, easy pace, rhythmic breathing	Beginning-level aerobic training, reduces stress
2	60–70%	Comfortable pace, slightly deeper breathing, conversation possible	Basic cardiovascular training, good recovery pace
3	70–80%	Moderate pace, more difficult to hold conversation	Improved aerobic capacity, optimal cardiovascular training
4	80–90%	Fast pace and a bit uncomfortable, breathing forceful	Improved anaerobic capacity and threshold, improved speed
5	90–100%	Sprinting pace, unsustainable for long period of time, labored breathing	Anaerobic and muscular endurance, increased power

