

GARMIN®



**DĚZL™ OTR820 / OTR1020 /
LGV820 / LGV1020**

Owner's Manual

© 2024 Garmin Ltd. or its subsidiaries

All rights reserved. Under the copyright laws, this manual may not be copied, in whole or in part, without the written consent of Garmin. Garmin reserves the right to change or improve its products and to make changes in the content of this manual without obligation to notify any person or organization of such changes or improvements. Go to www.garmin.com for current updates and supplemental information concerning the use of this product.

Garmin® and the Garmin logo are trademarks of Garmin Ltd. or its subsidiaries, registered in the USA and other countries. These trademarks may not be used without the express permission of Garmin.

BC™, dēzl™, Garmin eLog™, Garmin Express™, and myTrends™ are trademarks of Garmin Ltd. or its subsidiaries. These trademarks may not be used without the express permission of Garmin.

Android™ is a trademark of Google LLC. Apple® and Mac® are trademarks of Apple Inc, registered in the U.S. and other countries. The BLUETOOTH® word mark and logos are owned by the Bluetooth SIG, Inc., and any use of such word mark or logo by Garmin is under license. CAT Scale® is a registered trademark of CAT Scale Company. Foursquare® is a trademark of Foursquare Labs, Inc. in the U.S. and in other countries. Love's® and Love's Travel Stops® are registered trademarks of Love's Travel Stops & Country Stores, Inc. microSD® and the microSDHC logo are trademarks of SD-3C, LLC. Pilot Flying J™ and Pilot Flying J Travel Centers™ are trademarks of Pilot Travel Centers LLC and its affiliate companies. PrePass® is a trademark of the PrePass Safety Alliance. TripAdvisor® is a registered trademark of TripAdvisor LLC. TruckDown® is the trademark of TruckDown Info International, Inc. Windows® is a registered trademark of Microsoft Corporation in the United States and other countries. Wi-Fi® is a registered trademark of Wi-Fi Alliance Corporation.

Table of Contents

Getting Started.....	1	Finding Parking Near Your Current Location.....	18
Device Overview.....	1	Search Tools.....	18
Mounting and Powering the Device in Your Vehicle.....	2	Finding an Intersection.....	18
Installing the Screw-Down Mount on the Dashboard.....	4	Finding a Location Using Coordinates.....	18
Installing the Ball Mount Adapter.....	6	Viewing Recently Found Locations.....	18
Turning the Device On or Off.....	7	Clearing the List of Recently Found Locations.....	18
Acquiring GPS Signals.....	7	Viewing Current Location Information.....	19
Home Screen.....	8	Finding Emergency Services and Fuel.....	19
Opening an App.....	9	Getting Directions to Your Current Location.....	19
Status Bar Icons.....	9	Adding a Shortcut.....	19
Using the Touchscreen.....	9	Removing a Shortcut.....	19
Adjusting the Screen Brightness.....	9	Saving Locations.....	19
Adjusting the Volume.....	10	Saving a Location.....	19
Vehicle Profiles.....	10	Saving Your Current Location.....	20
Adding a Vehicle Profile.....	10	Editing a Saved Location.....	20
Car Profile.....	10	Deleting a Saved Location.....	20
Switching the Vehicle Profile.....	10	Navigating to Your Destination.....	20
Changing Your Trailer Information.....	11	Routes.....	20
Editing a Vehicle Profile.....	11	Starting a Route.....	21
Driver Awareness Features and Alerts.....	12	Starting a Route by Using the Map... ..	21
Enabling or Disabling Driver Alerts.....	12	Going Home.....	21
Red Light and Speed Cameras.....	13	Your Route on the Map.....	21
Finding and Saving Locations.....	13	Active Lane Guidance.....	24
Finding a Location Using the Search Bar.....	14	Viewing Popular Truck Paths on the Map.....	24
Finding an Address.....	14	Viewing Turns and Directions.....	24
Location Search Results.....	15	Viewing the Entire Route on the Map.....	24
Changing the Search Area.....	16	Planning Your Arrival.....	25
Points of Interest.....	16	Arriving at Your Destination.....	25
Finding Trucking Points of Interest.. ..	16	Completing a Truck Route.....	25
Finding TruckDown® Points of Interest.....	16	Parking Near Your Destination.....	26
Finding CAT Scale® Locations.....	17	Changing Your Active Route.....	26
Tripadvisor.....	17	Adding a Location to Your Route.....	26
Foursquare.....	17	Shaping Your Route.....	26
Finding a Location by Category.....	17	Taking a Detour.....	27
Parking.....	18	Changing the Route Calculation Mode.....	27
Finding Truck Parking.....	18	Stopping the Route.....	27
Using Truck Parking Europe.....	18	Using Suggested Routes.....	27
		Avoiding Delays, Tolls, and Areas.....	27

Avoiding Traffic Delays on Your Route.....	27	Enabling or Disabling Bluetooth Features.....	37
Avoiding Road Features.....	27	Showing or Hiding App Notifications.....	37
Avoiding Environmental Zones.....	28	Disconnecting a Bluetooth Device.....	37
Custom Avoidances.....	28	Deleting a Paired Phone.....	37
Using the Map.....	29	Traffic.....	37
Map Tools.....	29	Receiving Traffic Data Using Your Smartphone.....	37
Viewing a Map Tool.....	30	Viewing Traffic on the Map.....	37
Up Ahead.....	30	Searching for Traffic Incidents.....	38
Viewing Upcoming Locations.....	30	Vehicle and Driver Tools.....	38
Customizing the Up Ahead Categories.....	30	Break Planning.....	38
Cities Ahead.....	30	Taking a Suggested Break.....	38
Viewing Upcoming Cities and Exit Services.....	30	Starting the Break Timer.....	38
Road Restrictions on the Map.....	31	Pausing and Resetting the Break Timer.....	38
Warning and Alert Symbols.....	31	Adjusting Drive Hours.....	38
Restriction Warnings.....	32	Garmin eLog.....	39
Road Condition Warnings.....	32	Setting Up Garmin eLog Features On Your dēzl Device.....	39
Alerts.....	33	Viewing Garmin eLog Information on Your dēzl Device.....	39
Trip Information.....	33	Viewing Garmin eLog Diagnostic and Malfunction Events.....	39
Viewing Trip Data from the Map.....	33	IFTA.....	39
Viewing Your Trip History.....	33	Entering Fuel Data.....	40
Resetting Trip Information.....	33	Editing Fuel Data.....	40
Viewing Upcoming Traffic.....	33	Viewing and Exporting a Jurisdiction Summary.....	40
Viewing Traffic on the Map.....	33	Editing and Exporting Trip Reports..	40
Searching for Traffic Incidents.....	34	Viewing Exported Jurisdiction Summaries and Trip Reports.....	41
Customizing the Map.....	34	Logging Service History.....	41
Customizing the Map Layers.....	34	Adding Service Categories.....	41
Changing the Map Data Field.....	34	Deleting Service Categories.....	41
Changing the Map Perspective.....	34	Renaming Service Categories.....	41
		Deleting Service Records.....	41
		Editing a Service Record.....	42
		PrePass®.....	42
		Loyalty Programs.....	42
Live Services, Traffic, and Smartphone Features.....	34	Using the Apps.....	42
Pairing with Your Smartphone.....	35	Viewing the Owner's Manual on Your Device.....	42
Going to an Address or Location Using the dēzl App.....	35	Viewing the Truck Map.....	42
Smart Notifications.....	35		
Receiving Notifications while Viewing the Map.....	35		
Hands-Free Calling.....	36		
Enabling Hands-Free Calling.....	36		
Placing a Call.....	36		
Placing a Call Using Voice Dial.....	36		
Receiving a Call.....	36		
Using In-Call Options.....	36		

Route Planner.....	42	Device Settings and Product Information.....	53
Planning a Route.....	43	Resetting Data and Settings.....	53
Editing and Reordering Locations in a Route.....	43	Restoring Settings.....	53
Navigating to a Saved Route.....	43	Device Information.....	54
Editing and Saving Your Active Route.....	43	Viewing E-label Regulatory and Compliance Information.....	54
Viewing Previous Routes and Destinations.....	43	Specifications.....	54
Viewing the Weather Forecast.....	44	Charging the Device.....	54
Viewing the Weather Radar.....	44	Device Maintenance.....	54
Viewing the Wind Forecast.....	44	Garmin Support Center.....	54
Viewing Weather Near a Different City.....	44	Updating Maps and Software Using a Wi-Fi Network.....	55
Music Player.....	45	Updating Maps and Software with Garmin Express.....	56
Adding the Music Player Tool to the Map.....	45	Installing Garmin Express.....	57
Garmin PowerSwitch™ App.....	46	Charging the Device.....	57
Activating a Power Switch.....	46	Device Care.....	57
Turning Off All Switches.....	46	Cleaning the Outer Casing.....	57
Customizing a Button.....	47	Cleaning the USB Port.....	58
Assigning a Switch to a Control Input.....	47	Cleaning the Touchscreen.....	58
Adding a Custom Layout.....	47	Resetting the Device.....	58
Routines.....	48	Removing the Device, Mount, and Suction Cup.....	58
Voice Command.....	49	Removing the Mount from the Suction Cup.....	58
Tips for Speaking to the Device.....	49	Removing the Suction Cup from the Windshield.....	58
Launching Garmin Voice-Activated Navigation.....	50	Troubleshooting.....	58
Checking Your Arrival Time.....	50	The suction cup will not stay on my windshield.....	58
Placing a Phone Call Using Your Voice.....	50	The mount does not hold my device in place while I drive.....	58
Changing Device Settings Using Your Voice.....	50	My device is not acquiring satellite signals.....	58
Settings.....	50	The device does not charge in my vehicle.....	59
Phone Settings.....	50	My battery does not stay charged for very long.....	59
Wi-Fi Settings.....	50	My device does not connect to my phone.....	59
Connecting to a Wireless Network.....	51	Appendix.....	59
Map and Vehicle Settings.....	51	Viewing GPS Signal Status.....	59
Enabling Maps.....	51	Garmin PowerSwitch.....	59
Navigation Settings.....	51		
Traffic Settings.....	52		
Driver Assistance Settings.....	52		
Wireless Camera Settings.....	52		
Display Settings.....	52		
System Settings.....	53		

Mounting Considerations.....	59
Mounting the Device.....	60
Opening the Front Cover.....	61
Connecting Accessories.....	62
Connecting a Control Input.....	62
Connecting the Device to Vehicle Power.....	63
Pairing with a Garmin Navigation Device.....	63
Garmin PowerSwitch Specifications.....	64
Troubleshooting.....	64
Wireless Cameras.....	64
Pairing a BC™ 50 Camera with a Garmin Navigation Device.....	65
Connecting a Wired Backup Camera.....	65
Viewing the Backup Camera.....	66
Connecting a Dash Camera to the Powered Mount.....	67
Data Management.....	67
About Memory Cards.....	67
Installing a Memory Card for Maps and Data.....	67
Connecting the Device to Your Computer.....	68
Transferring Data From Your Computer.....	68
Purchasing Additional Maps.....	68
Purchasing Accessories.....	68

Getting Started

⚠ WARNING

See the *Important Safety and Product Information* guide in the product box for product warnings and other important information.

- Update the maps and software on your device ([Updating Maps and Software Using a Wi-Fi Network](#), page 55).
- Mount the device in your vehicle and connect it to power ([Mounting and Powering the Device in Your Vehicle](#), page 2).
- Acquire GPS signals ([Acquiring GPS Signals](#), page 7).
- Adjust the volume ([Adjusting the Volume](#), page 10) and display brightness ([Adjusting the Screen Brightness](#), page 9).
- Set up a vehicle profile ([Adding a Vehicle Profile](#), page 10).
- Navigate to your destination ([Starting a Route](#), page 21).

Device Overview

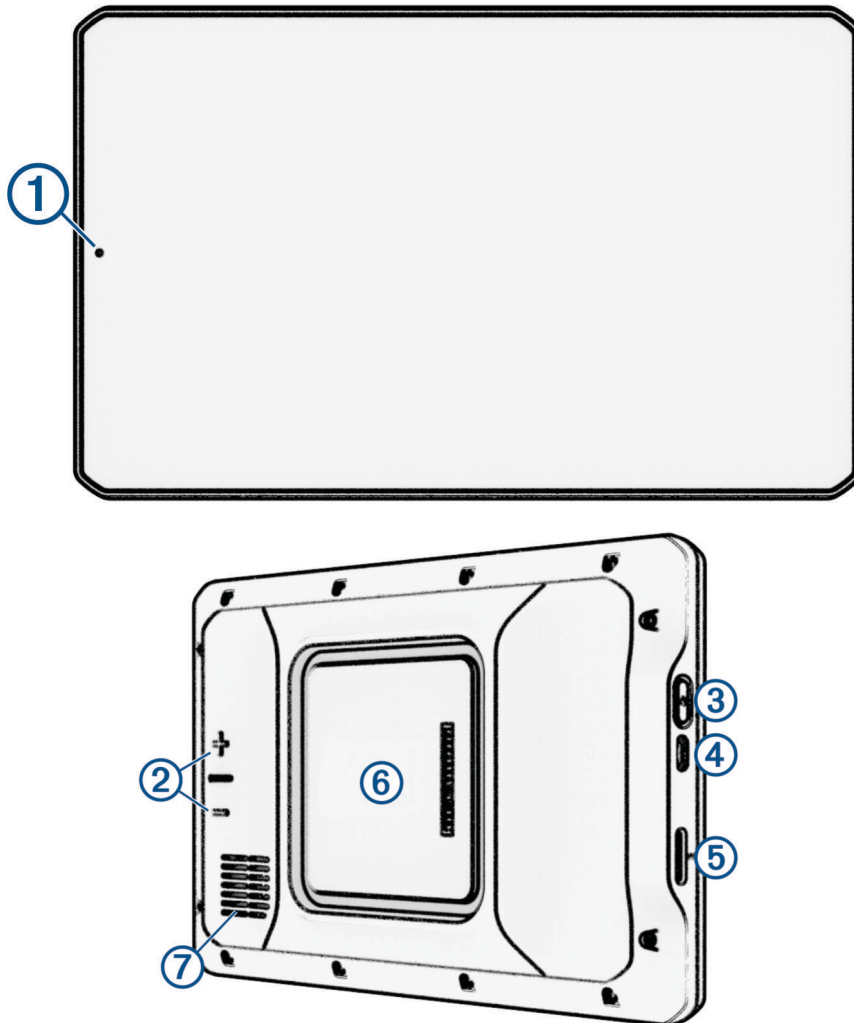

①	Microphone for hands-free calling and voice command
②	Volume control
③	Power key
④	USB power and data port
⑤	Map and data memory card slot
⑥	Magnetic mount interface with 14-pin connector
⑦	Speaker

Mounting and Powering the Device in Your Vehicle

⚠ WARNING

This product contains a lithium-ion battery. To prevent the possibility of personal injury or product damage caused by battery exposure to extreme heat, store the device out of direct sunlight.

Both the device and its mount contain magnets. Under certain circumstances, magnets may cause interference with some internal medical devices and electronic devices, including pacemakers, insulin pumps, or hard drives in laptop computers. Keep the device away from medical devices and electronic devices.

Before you use your device on battery power, you should charge it.

- 1 Open the lever ①, press the suction cup to the windshield, and flip the lever back toward the windshield. The lever must be oriented toward the top of the windshield.

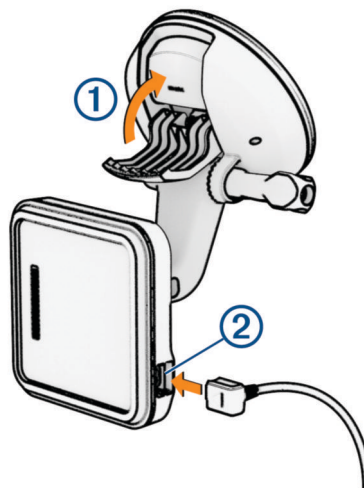

- 2 Plug the vehicle power cable into the port ② on the mount.

- 3 If necessary, loosen the thumbscrew on the suction cup arm ③ and the nut on the ball mount ④, and adjust the mount for better viewing and operation.

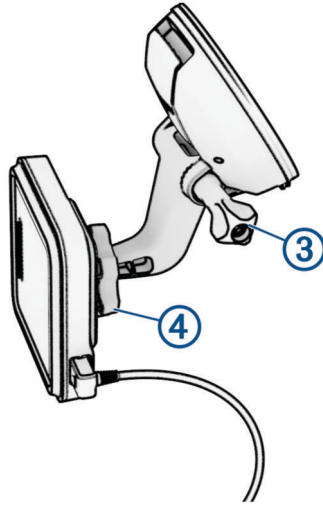

- 4 Tighten the thumbscrew on the suction cup arm and the nut on the ball mount.
5 Place the device onto the magnetic mount.

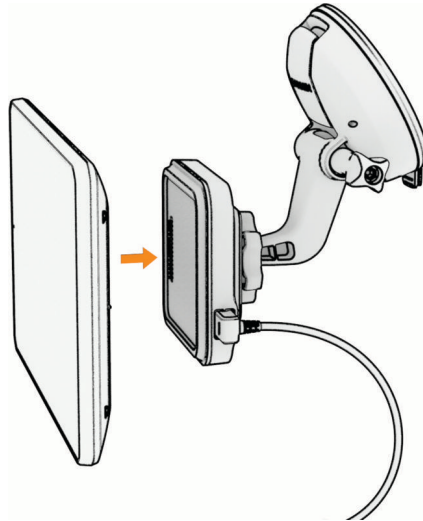

- 6 Plug the other end of the vehicle power cable into a power outlet in your vehicle.

Installing the Screw-Down Mount on the Dashboard

Before you can attach the screw-down ball mount to your dashboard, you must select a suitable location on the dashboard.

⚠ WARNING

It is your responsibility to ensure the mounting location complies with all applicable laws and ordinances, and does not block your view of the road during the safe operation of your vehicle.

NOTICE

Avoid wires, gauges, air bags, air bag covers, HVAC, and other items when drilling pilot holes and attaching the mount to the vehicle. Garmin® is not responsible for any damages or consequences arising from the installation.

NOTICE

To avoid possible damage to your vehicle, Garmin recommends professional installation of the screw-down ball mount.

- 1 Place the mount ① on the selected location.

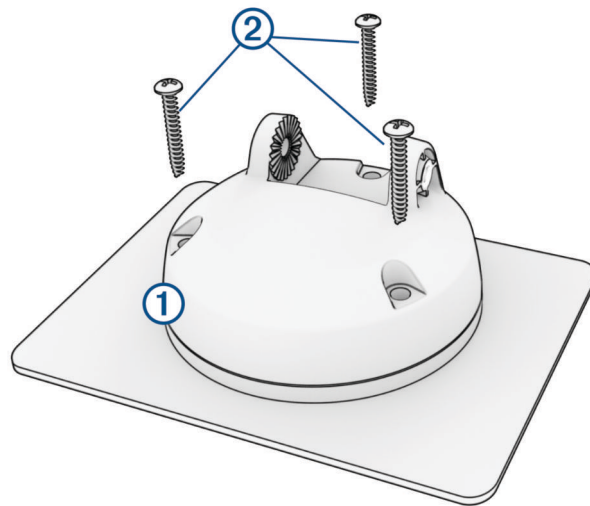

- 2 Using the mount as a template, mark the three screw locations.
- 3 Drill pilot holes (optional).
For some types of mounting material, drilling pilot holes is necessary.
- 4 Securely fasten the mount to the surface using the supplied screws ②.

5 Insert the ball mount arm ③ into the mount.

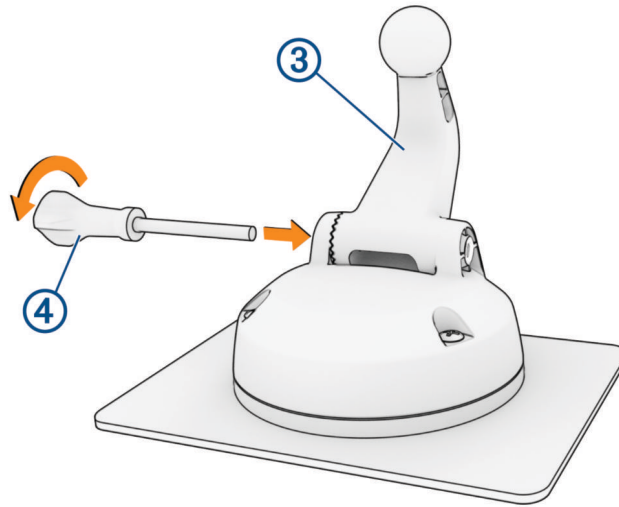

6 Insert the thumbscrew ④ into the mount, and tighten it to secure the ball mount arm.

Installing the Ball Mount Adapter

Your device includes a one-inch ball mount that is compatible with third-party mounting solutions.

- 1 Remove the four screws ① securing the mount socket ② to the magnetic mount.

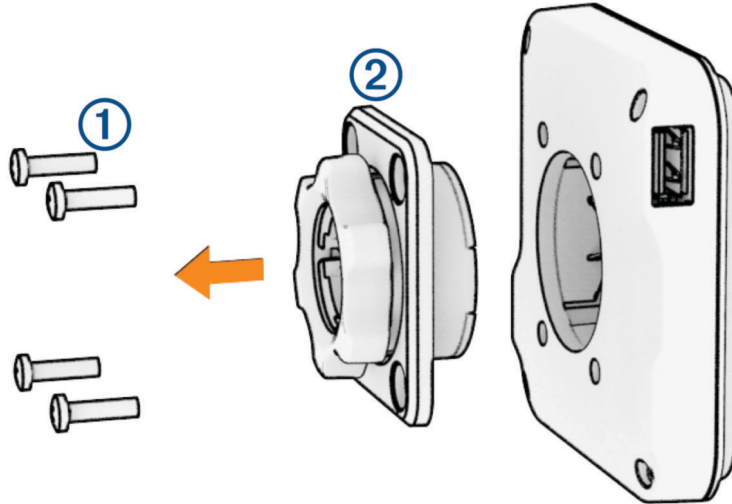

- 2 Remove the mount socket.

- 3 Secure the one-inch ball mount ③ to the magnetic mount using the screws removed in step 1.

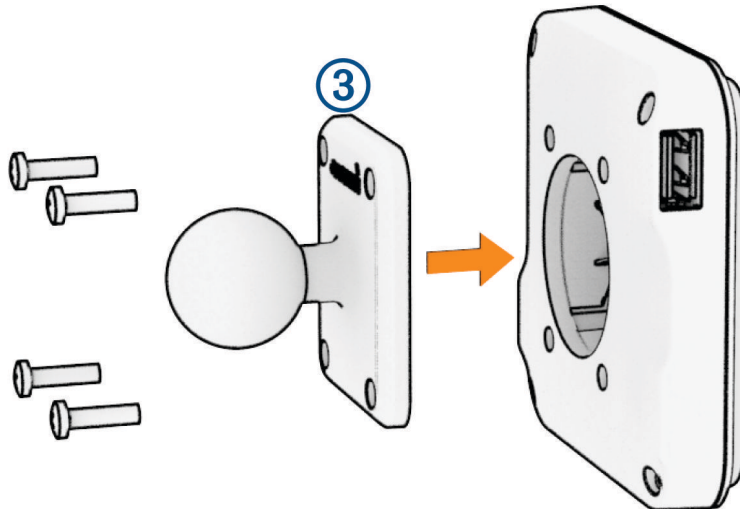

Turning the Device On or Off

- To turn the device on, press the power button ①, or connect the device to power.

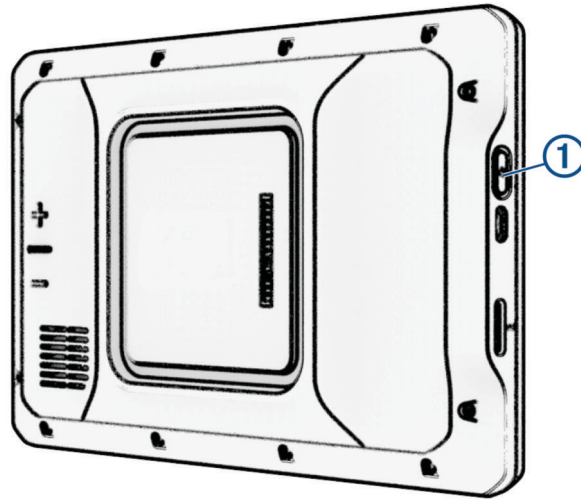

- To put the device in power saving mode, press the power button while the device is on. While in power saving mode, the screen is off and the device uses very little power, but it can wake instantly for use.
TIP: You can charge your device faster by putting it in power saving mode while charging the battery.
- To turn off the device completely, hold the power button until a prompt appears on the screen, and select **Off**. The prompt appears after five seconds. If you release the power button before the prompt appears, the device enters power saving mode.

Acquiring GPS Signals

When you turn on your navigation device, the GPS receiver must collect satellite data and establish the current location. The time required to acquire satellite signals varies based on several factors, including how far you are from the location where you last used your navigation device, whether you have a clear view of the sky, and how long it has been since you last used your navigation device. The first time you turn on your navigation device, it may take several minutes to acquire satellite signals.

- 1 Turn on the device.
- 2 Wait while the device locates satellites.
- 3 If necessary, go to an open area, away from tall buildings and trees.

■ ■ ■ ■ in the status bar indicates the satellite signal strength. When at least half the bars are filled, the device is ready for navigation.

Home Screen



- ① Select to start a route.
- ② Select to view the map.
- ③ Select various app shortcuts to use features on your navigation device.
- ④ The current vehicle profile.
- ⑤ The battery status.
- ⑥ Select to stop an active route.
- ⑦ Select to open the apps menu. The app drawer contains shortcuts to all of the apps available on your device.
- ⑧ Select to adjust the volume.
- ⑨ Select to view device settings and update software.

Opening an App











The home screen contains shortcuts for frequently used apps. The app drawer contains all of the apps installed on your device.

Select an option:

- Select an app shortcut from the home screen.
- Select  and select an app.

Status Bar Icons

The status bar is located at the top of the main menu. The status bar icons display information about features on the device. You can select some icons to change settings or view additional information.

	GPS signal status. Hold to view GPS accuracy and acquired satellite information (Viewing GPS Signal Status, page 59).
	Bluetooth® technology status. Select to view the Bluetooth settings (Phone Settings, page 50).
	Wi-Fi® signal strength. Select to change the Wi-Fi settings (Connecting to a Wireless Network, page 51).
	Connected to hands-free calling. Select to place a phone call (Hands-Free Calling, page 36).
	Active vehicle profile. Select to view the vehicle profile settings (Editing a Vehicle Profile, page 11).
	Garmin eLog™ status. Select to view the current ELD information. When the icon is blue, the device is connected to the Garmin eLog app.
	Current time. Select to set the time.
	Battery charge level.
	dēzl app connection status (Pairing with Your Smartphone, page 35).
	Temperature. Select to view the weather forecast (Viewing the Weather Forecast, page 44).



Using the Touchscreen

- Tap the screen to select an item.
- Drag or swipe your finger across the screen to pan or scroll.
- Pinch two fingers together to zoom out.
- Spread two fingers apart to zoom in.

Adjusting the Screen Brightness

- 1 Select  > **Display** > **Brightness**.
- 2 Use the slider bar to adjust the brightness.

Adjusting the Volume

- 1 Select .
- 2 Select an option:
 - Use the slider bar to adjust the volume.
 - Select  to mute the device.
 - Select a check box to enable or disable additional sound options.

Vehicle Profiles

WARNING



Entering your vehicle profile characteristics does not guarantee that your vehicle's characteristics will be accounted for in all route suggestions or that you will receive the warning icons in all cases. Limitations may exist in the map data such that your device cannot account for these restrictions or road conditions in all cases. Always defer to all posted road signs and road conditions when making driving decisions.

Routing and navigation are calculated differently based on your vehicle profile. The activated vehicle profile is indicated by an icon in the status bar. The navigation and map settings on your device can be customized separately for each vehicle type.

When you activate a truck vehicle profile, the device avoids including restricted or impassable areas in routes based on the dimensions, weight, and other characteristics you entered for your vehicle.

Adding a Vehicle Profile

You can add a vehicle profile that includes the weight, dimensions, and other characteristics for your vehicle.

- 1 From the home screen, select  > **Vehicle Profile** > .
- 2 Select an option:
 - To add a straight truck with a permanently attached cargo area, select **Straight Truck**.
 - To add a tractor or a tractor-trailer combination, select **Tractor**.
 - To add a bus, select **Bus**.
- 3 Follow the on-screen instructions to enter the vehicle characteristics.



After you add a vehicle profile, you can edit the profile to enter additional detailed information, such as the vehicle identification number or trailer number ([Editing a Vehicle Profile, page 11](#)).

Car Profile

The car profile is a preloaded vehicle profile intended for use in an automobile without a trailer. While using the car profile, the device calculates standard automobile routes, and routing for large vehicles is not available. Some features and settings specific to large vehicles are not available while using the car profile.

Switching the Vehicle Profile

Each time you turn on your device, it prompts you to select a vehicle profile. You can manually switch to another vehicle profile at any time.



- 1 From the status bar, select the vehicle profile icon, such as  or .
- 2 Select a vehicle profile.

The vehicle profile information appears, including measurements and weight.
- 3 Select **Select**.

Changing Your Trailer Information







Before you can change your trailer information, you must enter a vehicle profile for a tractor ([Adding a Vehicle Profile](#), page 10).

When you change the trailer on your tractor, you can change the trailer information in your vehicle profile without changing the tractor information. You can switch quickly between frequently used trailers.

- 1 From the home screen, select  > **Vehicle Profile**.
- 2 Select the tractor vehicle profile to use with the trailer.
- 3 Select .
- 4 Select an option:
 - To use a recent trailer configuration, select a trailer configuration from the list.
 - To enter a new trailer configuration, select **New Configuration**, and enter the trailer information.

Editing a Vehicle Profile

You can edit a vehicle profile to change vehicle information or to add detailed information to a new vehicle profile, such as the vehicle identification number, trailer number, or odometer reading. You can also rename or delete a vehicle profile.

- 1 From the home screen, select  > **Vehicle Profile**.
- 2 Select the vehicle profile to edit.
- 3 Select an option:
 - To edit the vehicle profile information, select , and select a field to edit.
 - To rename a vehicle profile, select  >  > **Rename Profile**.
 - To delete the vehicle profile, select  >  > **Delete**.

Driver Awareness Features and Alerts

CAUTION

The driver alerts and speed limit features are for information only and do not replace your responsibility to abide by all posted speed limit signs and to use safe driving judgment at all times. Garmin is not responsible for any traffic fines or citations you receive for failing to follow all applicable traffic laws and signs.

Your device provides features that can help encourage safer driving and increase efficiency, even when you are driving in a familiar area. The device plays an audible tone or message and displays information for each alert. You can enable or disable the audible tone for some types of driver alerts. Not all alerts are available in all areas.

Schools: The device plays a tone and displays the speed limit (if available) for an upcoming school or school zone.

Speed limit exceeded: The device displays a red border on the speed limit icon when you exceed the posted speed limit for the current road.

Speed limit reduced: The device plays a tone and displays the upcoming speed limit so you can be prepared to adjust your speed.

Wrong way on a one-way street: The device plays a message and displays a full-screen warning if you travel the wrong way on a one-way street. The edges of the screen appear red and an alert remains at the top of the screen until you leave the one-way street or correct your direction of travel.

Railroad crossing: The device displays the distance to an upcoming railroad crossing.

Animal crossing: The device plays a tone to indicate an upcoming animal crossing area.

Curves: The device plays a tone to indicate a bend in the road.

Slower traffic: The device plays a tone to indicate slower traffic when you approach slower traffic at a higher speed. Your device must be receiving traffic information to use this feature ([Traffic, page 37](#)).

Construction zone: The device plays a tone and displays a message when you approach a construction zone.

Lane closure: The device plays a tone and displays a message when you approach a lane closure.

Break planning: The device plays a tone and suggests upcoming rest stops after you have been driving for a long time.

No trucks allowed: The device plays a tone when you approach a road where no trucks are allowed.

Risk of grounding: The device plays a tone and displays a message when you approach a road where your vehicle could become grounded.

Lateral wind: The device plays a tone and displays a message when you approach a road where there is risk of lateral wind.

Narrow road: The device plays a tone and displays a message when you approach a road that may be too narrow for your vehicle.

Steep hill: The device plays a tone and displays a message when you approach a steep hill.

State and country borders: The device plays a tone and displays a message when you approach the border of a state or country.

Enabling or Disabling Driver Alerts

You can enable or disable several types of driver alerts.

- 1 Select  > **Driver Assistance** > **Driver Alerts**.
- 2 Select or clear the check box next to each alert.

Red Light and Speed Cameras

NOTICE

Garmin is not responsible for the accuracy of or the consequences of using a red light or speed camera database.

NOTE: This feature is not available for all regions or product models.

Information about red light and speed camera locations is available in some areas for some product models. The device alerts you when you approach a reported speed or red light camera.

- In some areas, your device can receive red light and speed camera data while connected to a smartphone running the *dēzl* app.
- You can use the Garmin Express™ software (garmin.com/express) to update the camera database stored on your device. You should update your device frequently to receive the most up-to-date camera information.

Finding and Saving Locations

The maps loaded in your device contain locations, such as restaurants, hotels, auto services, and detailed street information. The Where To? menu helps you find your destination by providing several methods to browse, search, and save this information.

From the main menu, select **Where To?**

- To quickly search all locations on your device, select **Search** (*Finding a Location Using the Search Bar, page 14*).
- To find an address, select **Address** (*Finding an Address, page 14*).
- To browse or search pre-loaded points of interest by category, select **Categories** (*Finding a Location by Category, page 17*).
- To search near a different city or area, select the current search area, and select a new search area (*Changing the Search Area, page 16*).
- To view and edit your saved locations, select **Saved** (*Saving Locations, page 19*).
- To view locations you have recently selected from the search results, select **Recent** (*Viewing Recently Found Locations, page 18*).
- To search for truck stops, truck parking, and truck services, select **Categories > Trucking** (*Finding Trucking Points of Interest, page 16*).
- To browse and search Foursquare® points of interest, select **Foursquare**.
- To browse and search Tripadvisor® traveler ratings, select **Tripadvisor** (*Tripadvisor, page 17*).
- To navigate to specific geographic coordinates, select **Coordinates** (*Finding a Location Using Coordinates, page 18*).

Finding a Location Using the Search Bar

You can use the search bar to search for locations by entering a category, brand name, address, or city name.

- 1 Select **Where To?**.
- 2 Select **Search** in the search bar.
- 3 Enter all or part of the search term.
Suggested search terms appear below the search bar.
- 4 Select an option:
 - To search for a type of business, enter a category name (for example, "movie theaters").
 - To search for a business name, enter all or part of the name.
 - To search for an address near you, enter the house number and street name.
 - To search for an address in another city, enter the house number, street name, city, and state.
 - To search for a city, enter the city and state.
 - To search for coordinates, enter latitude and longitude coordinates.
- 5 Select an option:
 - To search using a suggested search term, select the term.
 - To search using the text you entered, select .
- 6 If necessary, select a location.

Finding an Address

NOTE: The order of the steps may change depending on the map data loaded on your device.

- 1 Select **Where To?**.
- 2 If necessary, select the current search area to search near a different city or area.
- 3 Select **Address**.
- 4 Follow the on-screen instructions to enter address information.
- 5 Select the address.

Location Search Results

The location search results appear in a list, with the nearest location at the top. Each numbered location also appears on the map. You can scroll down to view more results.

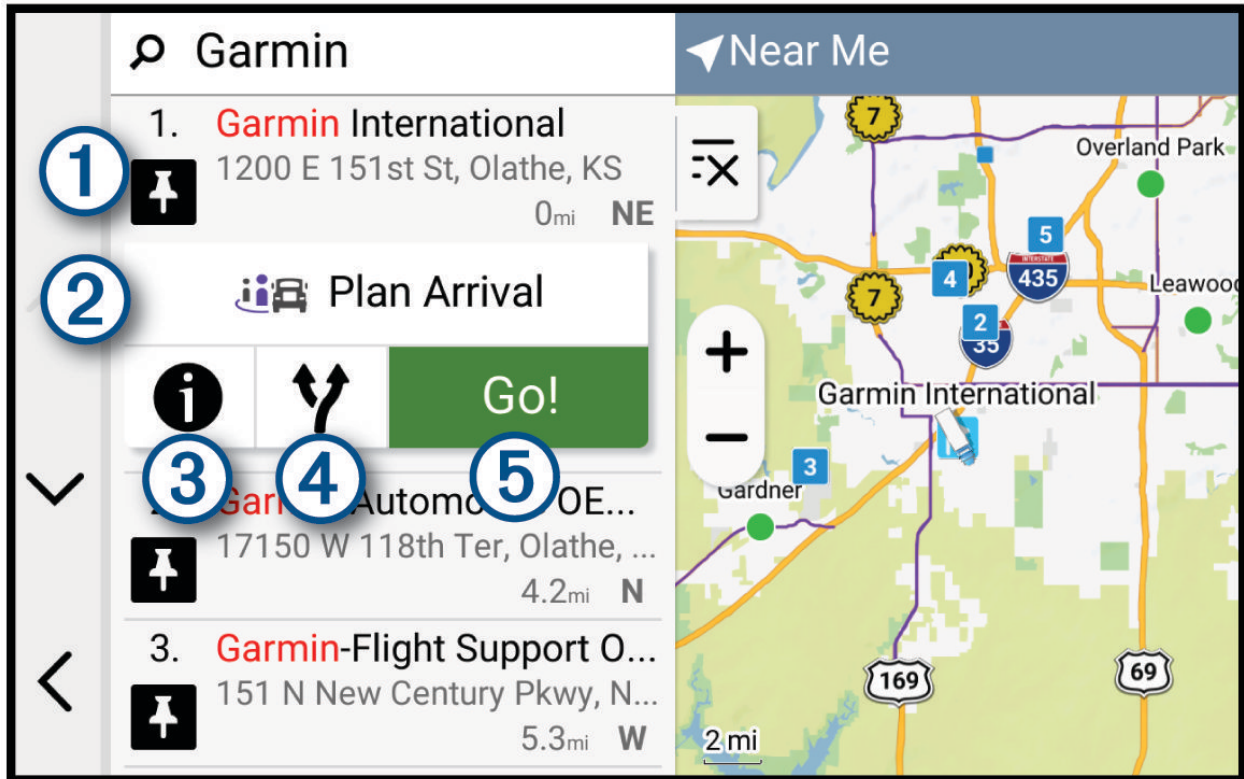

①	Select a location to view the option menu.
② Plan Arrival	Select to view a map of your destination and find a truck destination.
③ i	Select to view detailed information about the location.
④ Y	Select to view alternate routes to the location.
⑤ Go!	Select to start navigating to the location using the recommended route.

Changing the Search Area

By default, the device searches for locations near your current location. You can also search other areas, such as near your destination, near another city, or along your active route.

- 1 Select **Where To?**.
- 2 Select the current search area ①.

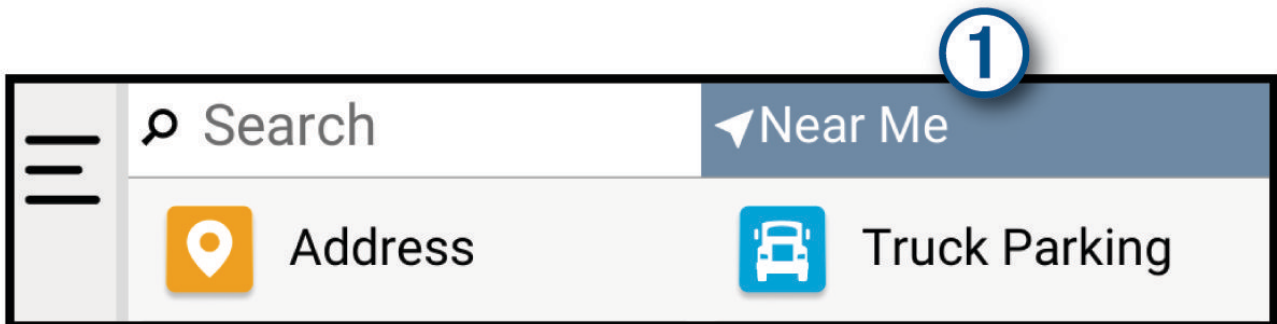

- 3 Select a search area.
- 4 If necessary, follow the on-screen instructions to select a specific location.

The selected search area appears at the top of the screen. When you search for a location using any of the options in the Where To? menu, the device suggests locations near this area first.

Points of Interest

NOTICE

You are responsible for understanding and complying with any applicable rules, laws, or regulations associated with points of interest.

A point of interest is a place that you may find useful or interesting. Points of interest are organized by category and can include popular travel destinations such as gas stations, restaurants, hotels, and entertainment venues.

Finding Trucking Points of Interest

NOTICE

You are responsible for understanding and complying with any applicable rules, laws, or regulations associated with points of interest.

The detailed maps loaded in your device contain trucking points of interest, such as truck stops, rest areas, and weigh stations.

Select **Where To? > Categories > Trucking**.

Finding TruckDown[®] Points of Interest

The TruckDown directory lists businesses for the trucking industry such as truck repair and tire sales. The TruckDown directory is available only in North America.

- 1 Select **Where To?**.
- 2 Select an option:
 - Select **Truck Locations** to find points of interest compatible with trucks.
 - Select **Truck Services** to find service locations for your truck.
- 3 Select a category.
- 4 If necessary, select **Filter by Amenities & Brands**, select one or more amenities, and select **Save**.
NOTE: This option is available for truck stops only.
- 5 Select a destination.

Finding CAT Scale Locations

You can use the included database to search for CAT Scale locations in North America.

- 1 Select **Where To? > CAT Scale**.
- 2 Select a destination.

Tripadvisor

NOTICE

Garmin is not responsible for the accuracy or timeliness of the Tripadvisor information.

You are responsible for understanding and complying with any applicable rules, laws, or regulations associated with points of interest.

Your device includes Tripadvisor traveler ratings. Tripadvisor ratings appear automatically in the search results list for restaurants, hotels, and attractions. You can also search for nearby Tripadvisor points of interest and sort by distance or popularity.

Finding Tripadvisor Points of Interest

- 1 Select **Where To? > Tripadvisor**.
- 2 Select a category.
- 3 If necessary, select a subcategory.
A list of nearby Tripadvisor points of interest for the category appears.
- 4 Select **Sort Results** to filter the displayed points of interest by distance or popularity (optional).
- 5 Select , and enter a search term (optional).

Foursquare

NOTICE

Garmin is not responsible for the accuracy or timeliness of information provided by Foursquare.

You are responsible for understanding and complying with any applicable rules, laws, or regulations associated with points of interest.

Foursquare is a location-based social network. Your device includes millions of pre-loaded Foursquare points of interest, which are indicated by the Foursquare logo in your location search results.

Searching Foursquare Points of Interest

You can search for Foursquare points of interest loaded on your device.

Select **Where To? > Foursquare**.

Viewing Foursquare Location Details

You can view Foursquare location information and user ratings.

- 1 From the location search results, select a Foursquare point of interest.
- 2 Select .

Finding a Location by Category

- 1 Select **Where To?**.
- 2 Select a category, or select **Categories**.
- 3 If necessary, select a subcategory.
- 4 Select a location.

Parking

Finding Truck Parking

- 1 Select **Where To?** > **Truck Parking**.
- 2 Select a parking location.
- 3 Select **Go!**.

Using Truck Parking Europe

If you pair your dēzl device with the dēzl app and log in to your Truck Parking Europe account, you can view parking availability and ratings on your navigation device.

NOTE: This feature is available only in Europe.

- 1 Select **Where To?** > **Truck Parking Europe**.
- 2 If necessary, select **Filter by Amenities & Brands**, select one or more attributes, and select **Search**.
- 3 Select a parking location.
- 4 Select **Go!**.

Finding Parking Near Your Current Location

- 1 Select **Where To?** > **Categories** > **Parking**.
- 2 Select a parking location.
- 3 Select **Go!**.

Search Tools

Search tools allow you to search for specific types of locations by responding to on-screen prompts.

Finding an Intersection

You can search for an intersection or junction between two streets, highways, or other roads.

- 1 Select **Where To?** > **Intersections**.
- 2 Follow the on-screen instructions to enter street information.
- 3 Select the intersection.

Finding a Location Using Coordinates

You can find a location using latitude and longitude coordinates.

- 1 Select **Where To?** > **Coordinates**.
- 2 If necessary, select , and change the coordinate format or datum.
- 3 Select **Coordinates**.
- 4 Enter the latitude and longitude coordinates, and select **Done**.
- 5 Select an option:
 - To save the coordinates as a location, select **Save**.
 - To start a route to the coordinates, select **Go!**.

Viewing Recently Found Locations

Your device stores a history of the last 50 locations you have found.

Select **Where To?** > **Recent**.

Clearing the List of Recently Found Locations

Select **Where To?** > **Recent** >  > **Clear** > **Yes**.

Viewing Current Location Information

You can use the Where Am I? page to view information about your current location. This feature is helpful if you need to tell emergency personnel your location.

From the map, select the vehicle.

Finding Emergency Services and Fuel

You can use the Where Am I? page to find the nearest hospitals, police stations, and fuel stations.

1 From the map, select the vehicle.

2 Select **Hospitals, Police Stations, Truck Stops, or Fuel.**

NOTE: Some service categories are not available in all areas.

NOTE: When a truck vehicle profile is active, an option for truck stops appears instead of fuel.

A list of locations for the selected service appears, with the nearest locations at the top.

3 Select a location.

4 Select an option:

- To navigate to the location, select **Go!**.
- To view the phone number and other location details, select **i**.

Getting Directions to Your Current Location

If you need to tell another person how to get to your current location, your device can give you a list of directions.

1 From the map, select the vehicle.

2 Select  > **Directions to Me.**

3 Select a starting location.

4 Select **Select.**

Adding a Shortcut

You can add shortcuts to the Where To? menu. A shortcut can point to a location, a category, or a search tool.

The Where To? menu can contain up to 36 shortcut icons.

1 Select **Where To? > Add Shortcut.**

2 Select an item.

Removing a Shortcut

1 Select **Where To? >  > Remove Shortcut(s).**

2 Select a shortcut to remove.

3 Select the shortcut again to confirm.

4 Select **Done.**

Saving Locations

Saving a Location

1 Search for a location ([Finding a Location by Category, page 17](#)).

2 From the search results, select a location.

3 Select **i** > **Save.**

4 If necessary, enter a name, and select **Done.**

5 Select **Save.**

Saved locations synchronize to your Garmin account automatically while you are connected to the dēzl app on your compatible phone.

Saving Your Current Location

- 1 From the map, select the vehicle icon.
- 2 Select **Save**.
- 3 Enter a name, and select **Done**.

Editing a Saved Location

- 1 Select **Where To? > Saved**.
- 2 If necessary, select a category.
- 3 Select a location.
- 4 Select **Edit**.
- 5 Select an option:
 - Select **Name**.
 - Select **Map Symbol** to change the symbol used to mark the saved location on a map.
 - Select **Collections** to add or remove the location from your saved collection categories.
 - Select **Coordinates** to edit the GPS coordinates for the location.
- 6 Edit the information.
- 7 Select **Done**.

Deleting a Saved Location

NOTE: Deleted locations cannot be recovered.

- 1 Select **Where To? > Saved**.
- 2 Select a waypoint.
- 3 Select **Edit > Delete > Yes**.

Navigating to Your Destination

Routes

A route is a path from your current location to one or more destinations.

- The device calculates a recommended route to your destination based on the preferences you set, including the route calculation mode ([Changing the Route Calculation Mode, page 27](#)) and avoidances ([Avoiding Delays, Tolls, and Areas, page 27](#)).
- The device can automatically avoid roads that are not appropriate for the active vehicle profile.
- You can start navigating to your destination quickly using the recommended route, or you can select an alternate route ([Starting a Route, page 21](#)).
- If there are specific roads you need to use or avoid, you can customize the route ([Shaping Your Route, page 26](#)).
- You can add multiple destinations to a route ([Adding a Location to Your Route, page 26](#)).

Starting a Route

- 1 Select **Where To?**, and search for a location (*Finding and Saving Locations, page 13*).
- 2 Select a location.
- 3 Select an option:
 - To start navigating using the recommended route, select **Go!**.
 - To choose an alternate route, select **Y**, and select a route.
Alternate routes appear to the right of the map.
 - To edit the course of the route, select **Y** > **Edit Route**, and add shaping points to the route (*Shaping Your Route, page 26*).

The device calculates a route to the location and guides you using voice prompts and information on the map (*Your Route on the Map, page 21*). A preview of the major roads in your route appears at the edge of the map for several seconds.

If you need to stop at additional destinations, you can add the locations to your route (*Adding a Location to Your Route, page 26*).

Starting a Route by Using the Map

You can start a route by selecting a location from the map.

- 1 Select **View Map**.
- 2 Drag and zoom the map to display the area to search.
- 3 Select an option:
 - Select a location marker.
 - Select a point, such as a street, intersection, or address location.
- 4 Select **Go!**.

Going Home

The first time you start a route home, the device prompts you to enter your home location.

- 1 Select **Where To?** > **Go Home**.
- 2 If necessary, enter your home location.

Editing Your Home Location

- 1 Select **Where To?** >  > **Set Home Location**.
- 2 Enter your home location.

Your Route on the Map

As you travel, the device guides you to your destination using voice prompts and information on the map. Instructions for your next turn or exit, or other actions appear across the top of the map.



①	Next action in the route. Indicates the next turn, exit, or other action and the lane in which you should travel, if available.
②	Distance to the next action.
③	Name of the street or exit associated with the next action.
④	Notifications about your route.
⑤	Select to view an overview of the route.
⑥	Select to view upcoming points of interest along your route.
⑦	Select to view satellite imagery of your destination and plan your arrival. The dēzl app is required to download satellite imagery.
⑧	Select to search for points of interest along your route.
⑨	Select to toggle popular truck routes on the map.
⑩	Map tools. You can select tools to show you more information about your route and surroundings.
⑪	Data fields. TIP: You can touch these fields to change the information they show (<i>Changing the Map Data Field, page 34</i>).
⑫	Route highlighted on the map.

Active Lane Guidance

As you approach some turns, exits, or interchanges in your route, a detailed simulation of the road appears beside the map, if available. A colored line ① indicates the proper lane for the turn.

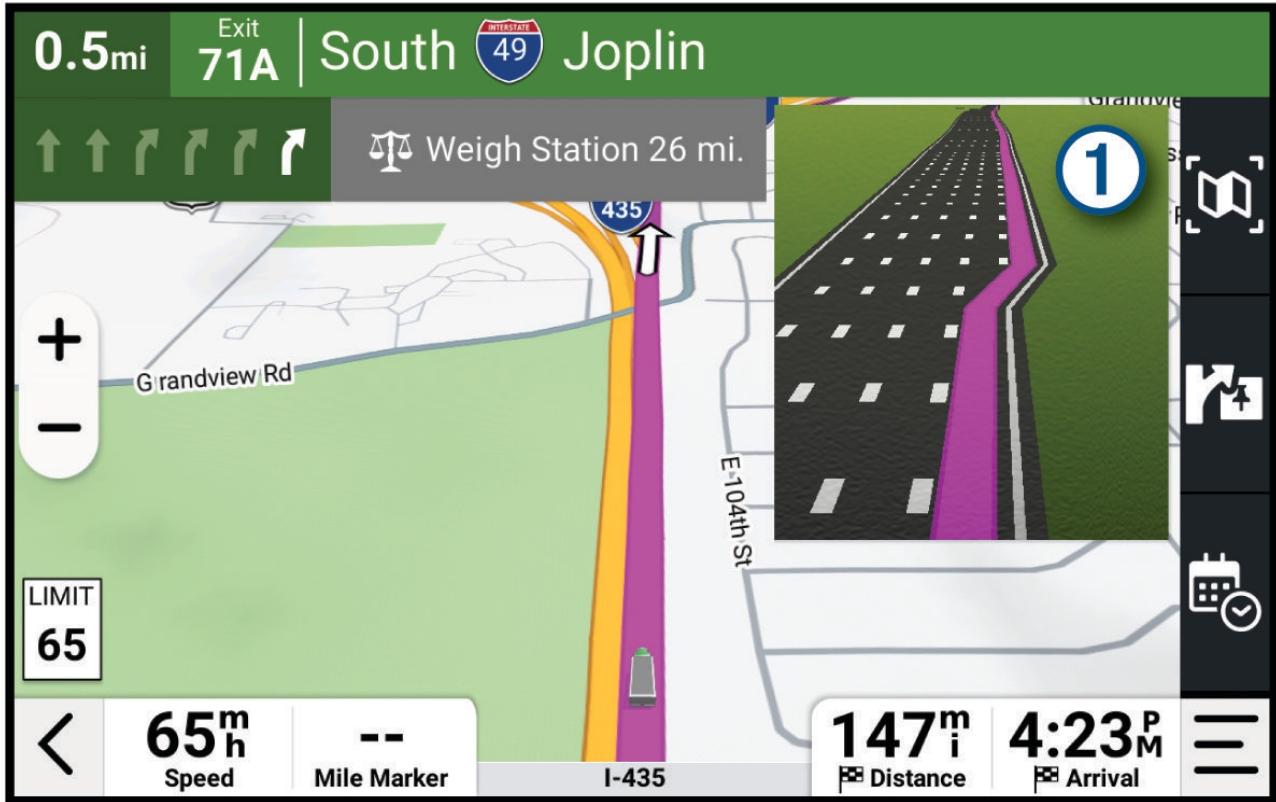

Viewing Popular Truck Paths on the Map

You can enable the device to highlight popular truck paths on the map. This can be useful to help you choose roads that are more accessible for your vehicle.

From the map, select .

Viewing Turns and Directions

While navigating a route, you can view upcoming turns, lane changes, or other directions for your route.

1 From the map, select an option:

- To view upcoming turns and directions as you navigate, select  > **Turns**.
The map tool displays the next several turns or directions beside the map. The list updates automatically as you navigate the route.
- To view the complete list of turns and directions for the entire route, select the text bar at the top of the map.

2 Select a turn or direction (optional).

Detailed information appears. An image of the junction may appear for junctions on major roadways, if available.

Viewing the Entire Route on the Map

- 1 While navigating a route, select anywhere on the map.
- 2 Select .

Planning Your Arrival

Before you start a route, you can plan to arrive at a popular truck destination, such as a loading dock or truck parking, at the end of your route. You can also add your own destinations to the map.



- 1 Select **Where To?**, and search for a location (*Finding and Saving Locations, page 13*).
- 2 Select a location.
- 3 Select **Plan Arrival**.

A preview of your destination appears on the map. Popular truck destinations appear next to the map. If your dēzl device is paired with the dēzl app, it downloads BirdsEye satellite imagery automatically.

- 4 Select a destination, and select **Go!**.

Arriving at Your Destination

When you approach your destination, the device provides information to help you complete your route.

-  indicates the location of your destination on the map, and a voice prompt announces you are approaching your destination.
- When you approach some destinations while using a truck vehicle profile, the device automatically prompts you to find a truck destination such as a loading dock or truck parking. You can select a suggested point on the map, and select Go! to navigate to that destination.
- When you stop at your destination, the device automatically ends the route. If the device does not detect your arrival automatically, you can select  > **Stop** to end your route.

Completing a Truck Route

When you approach some truck destinations, a map tool appears to help you find common truck destinations such as parking areas and loading docks.

- 1 Select the map tool .

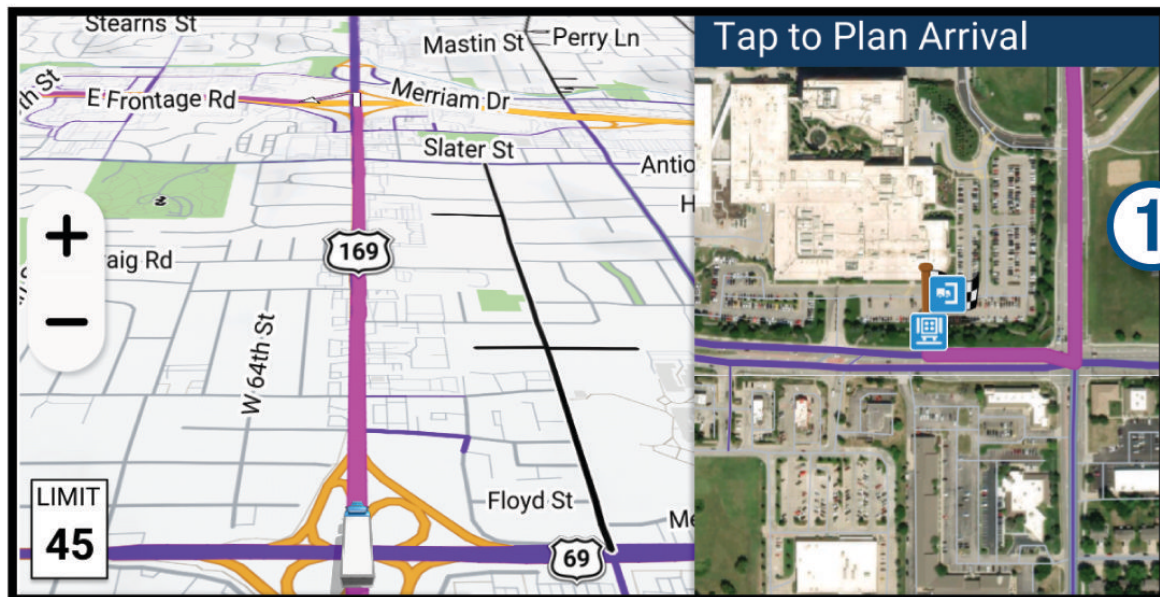

- 2 Touch the map, and select a trucking destination.
- 3 Select **Go!**.

Parking Near Your Destination

Your device can help you find a parking spot near your destination. When you approach some destinations, the device automatically suggests parking areas.

NOTE: This feature should be used only when you are using the car vehicle profile. While using a truck vehicle profile, you can search for truck parking near your destination ([Finding Truck Parking, page 18](#)).

1 Select an option:

- When the device suggests parking, select **More** to see all of the suggested parking areas.

NOTE: When you select a suggested parking area, the device automatically updates your route.

- If the device does not suggest parking locations, select **Where To? > Categories > Parking**, and select **Near Destination** for the search area.

2 Select a parking location, and select **Go!**.

The device guides you to the parking area.

Changing Your Active Route

Adding a Location to Your Route

Before you can add a location to your route, you must be navigating a route ([Starting a Route, page 21](#)).

You can add locations to the middle or end of your route. For example, you can add a fuel station as the next destination in your route.

TIP: To create complex routes with multiple destinations or scheduled stops, you can use the route planner to plan, schedule, and save a route ([Planning a Route, page 43](#)).

1 From the map, select  **Where To?**

2 Search for a location ([Finding and Saving Locations, page 13](#)).

3 Select a location.

4 Select **Go!**.

5 Select an option:

- To add the location as the next destination in your route, select **Add As Next Stop**.
- To add the location to the end of your route, select **Add As Last Stop**.
- To add the location and edit the order of destinations in your route, select **Add to Active Route**.

The device re-calculates the route to include the added location and guides you to the destinations in order.

Shaping Your Route

Before you can shape your route, you must start a route ([Starting a Route, page 21](#)).

You can manually shape your route to change its course. This allows you to direct the route to use a certain road or go through a certain area without adding a destination to the route.

1 From the map, select  **Edit Route > Shape Route**.

The device enters route shaping mode.

2 Select a map location to create a shaping point.

TIP: You can select  to zoom in on the map and select a more precise location.

3 If necessary, select an option:

- To add more shaping points to the route, select additional locations on the map.
- To remove a shaping point, select the shaping point and select .

4 Select .

Taking a Detour

You can take a detour for a specified distance along your route or detour around specific roads. This is useful if you encounter construction zones, closed roads, or poor road conditions.

- 1 From the map, select  > **Edit Route**.
- 2 Select an option:
 - To detour your route for a specific distance, select **Detour by Distance**.
 - To detour around a specific road on the route, select **Detour by Road**.

Changing the Route Calculation Mode

- 1 Select  > **Navigation** > **Calculation Mode**.
- 2 Select an option:
 - Select **Faster Time** to calculate routes that are faster to drive but can be longer in distance.
 - Select **Straight Line** to calculate point-to-point routes in a straight line.

Stopping the Route

- From the map, select  > **Stop**.
- From the home screen, select **Stop**.

Using Suggested Routes

Before you can use this feature, you must save at least one location and enable the travel history feature ([Device Settings and Product Information, page 53](#)).

Using the myTrends™ feature, your device predicts your destination based on your travel history, the day of the week, and the time of day. After you have driven to a saved location several times, the location may appear in the navigation bar on the map, along with the estimated time of travel, and traffic information.

Select the navigation bar to view a suggested route to the location.

Avoiding Delays, Tolls, and Areas

Avoiding Traffic Delays on Your Route

Before you can avoid traffic delays, you must be receiving traffic information ([Receiving Traffic Data Using Your Smartphone, page 37](#)).

By default, the device optimizes your route to avoid traffic delays automatically. If you have disabled this option in the traffic settings ([Traffic Settings, page 52](#)), you can view and avoid traffic delays manually.

- 1 While navigating a route, select  > **Traffic**.
- 2 Select **Alternate Route**, if available.
- 3 Select **Go!**.

Avoiding Road Features

- 1 Select  > **Navigation** > **Avoidances**.
- 2 Select the road features to avoid on your routes, and select **Save**.

Avoiding Environmental Zones

Your device can avoid areas with environmental or emissions restrictions that may apply to your vehicle. This option applies to the vehicle type in the active vehicle profile ([Vehicle Profiles, page 10](#)).

- 1 Select  > **Navigation** > **Environmental Zones**.
- 2 Select an option:
 - To be asked each time before routing through an environmental zone, select **Always Ask**.
 - To always avoid environmental zones, select **Avoid**.
 - To always allow environmental zones, select **Allow**.
- 3 Select **Save**.

Custom Avoidances

Custom avoidances allow you to select specific areas or sections of road to avoid. When the device calculates a route, it avoids these areas and roads unless no other reasonable route is available.

Avoiding a Road



- 1 Select  > **Navigation** > **Custom Avoidances**.
- 2 If necessary, select **Add Avoidance**.
- 3 Select **Add Avoid Road**.
- 4 Select the starting point of the section of road to avoid, and select **Next**.
- 5 Select the ending point of the road section, and select **Next**.
- 6 Select **Done**.

Avoiding an Area



- 1 Select  > **Navigation** > **Custom Avoidances**.
- 2 If necessary, select **Add Avoidance**.
- 3 Select **Add Avoid Area**.
- 4 Select the upper-left corner of the area to avoid, and select **Next**.
- 5 Select the lower-right corner of the area to avoid, and select **Next**.
The selected area is shaded on the map.
- 6 Select **Done**.

Disabling a Custom Avoidance

You can disable a custom avoidance without deleting it.





- 1 Select  > **Navigation** > **Custom Avoidances**.
- 2 Select an avoidance.
- 3 Select  > **Disable**.

Deleting Custom Avoidances

- 1 Select  > **Navigation** > **Custom Avoidances** > .
- 2 Select an option:
 - To delete all custom avoidances, select **Select All** > **Delete**.
 - To delete one custom avoidance, select the avoidance, and select **Delete**.

Using the Map

You can use the map to navigate a route ([Your Route on the Map, page 21](#)) or to view a map of your surroundings when no route is active.

- 1 Select **View Map**.
- 2 Touch anywhere on the map.
- 3 Select an option:
 - Drag the map to pan left, right, up, or down.
 - To add or remove map layers such as topographic and BirdsEye imagery, select .
 - To zoom in or out, select  or .
 - To switch between North Up, 2-D, and 3-D views, select .
 - To open the route planner, select  ([Route Planner, page 42](#)).
 - To start a route, select a location on the map, and select **Go!** ([Starting a Route by Using the Map, page 21](#)).

Map Tools

Map tools provide quick access to information and device functions while you view the map. When you activate a map tool, it appears in a panel at the edge of the map.

Stop: Stops navigation of the active route.

Edit Route: Allows you to take a detour or skip locations in your route ([Changing Your Active Route, page 26](#)).

Mute Navigation: Mutes the device audio.

Cities Ahead: Displays upcoming cities and services along your active route or along a highway ([Cities Ahead, page 30](#)).

Up Ahead: Displays upcoming locations along the route or the road on which you are traveling ([Up Ahead, page 30](#)).

Elevation: Displays upcoming elevation changes.

Traffic: Displays traffic conditions along your route or in your area ([Viewing Upcoming Traffic, page 33](#)). This feature is not available in all areas or for all device models.

Trip Data: Displays customizable trip data, such as speed or mileage ([Viewing Trip Data from the Map, page 33](#)).

Turns: Displays a list of upcoming turns in your route ([Viewing Turns and Directions, page 24](#)).

Phone: Displays a list of recent phone calls from your connected phone, and displays in-call options while a phone call is active ([Using In-Call Options, page 36](#)).

Weather: Displays weather conditions for your area.

Report Safety Camera: Allows you to report a speed or red light camera. This tool is available only when you have speed or red light camera data on your device and you have an active connection to the dēzl app.

Garmin eLog: Displays hours of service information from the Garmin eLog app..

Music: Displays media controls and media information.

Smart Notifications: Displays recent smart notifications from your connected phone ([Smart Notifications, page 35](#)).

PrePass®: Shows notifications for upcoming weigh stations and bypass decisions ([PrePass®, page 42](#)).

Plan Arrival: Displays a map of your destination and allows you to find a truck destination.

Love's: Displays upcoming Love's Travel Stops® along your route.

NOTE: This feature is available only in North America.



Pilot Flying J: Displays upcoming Pilot Flying J Travel Centers™ along your route.

NOTE: This feature is available only in North America.

Break Planner: Displays daily hours driven, total hours driven, and the time to your next break.

Overview Map: Displays an overview of your route on the map.

Viewing a Map Tool

- 1 From the map, select .
- 2 Select a map tool.
The map tool appears in a panel at the edge of the map.
- 3 When you are done using the map tool, select .

Up Ahead

The Up Ahead tool provides information about upcoming locations along your route or the road on which you are traveling. You can view upcoming points of interest by category, such as restaurants, fuel stations, or rest areas.



You can customize the categories that show in the Up Ahead tool.

Viewing Upcoming Locations

- 1 From the map, select  > **Up Ahead**.
While you are traveling, the map tool shows the next location along your road or route.
- 2 Select an option:
 - If the map tool shows categories, select a category to view a list of nearby locations in that category.
 - If the map tool shows upcoming locations, select a location to view location details or start a route to the location.

Customizing the Up Ahead Categories

You can change the location categories that appear in the Up Ahead tool.

- 1 From the map, select  > **Up Ahead**.
- 2 Select a category.
- 3 Select .
- 4 Select an option:
 - To move a category up or down in the list, select and drag the arrow next to the category name.
 - To change a category, select the category.
 - To create a custom category, select a category, select **Custom Search**, and enter the name of a business or category.
- 5 Select **Save**.

Cities Ahead

While you are traveling on a highway or navigating a route that includes a highway, the Cities Ahead tool provides information about upcoming cities along the highway. For each city, the map tool shows the distance to the highway exit and the services available, similar to the information on highway road signs.

Viewing Upcoming Cities and Exit Services



- 1 From the map, select  > **Cities Ahead**.
While you are traveling along a highway or an active route, the map tool shows information about upcoming cities and exits.
- 2 Select a city.
The device shows a list of points of interest located at the selected city exit, such as fuel stations, lodging, or restaurants.
- 3 Select a location, and select **Go!** to start navigating.

Road Restrictions on the Map

WARNING

Entering your vehicle profile characteristics does not guarantee that your vehicle's characteristics will be accounted for in all route suggestions or that you will receive the warning icons in all cases. Limitations may exist in the map data such that your device cannot account for these restrictions or road conditions in all cases. Always defer to all posted road signs and road conditions when making driving decisions.

Gray and black roads on the map indicate road restrictions for your current vehicle profile.

	Delivery road restrictions. The road is restricted for use for deliveries under specific conditions.
	All other road restrictions. The road may be inaccessible for your current vehicle profile.

Warning and Alert Symbols

WARNING

Entering your vehicle profile characteristics does not guarantee that your vehicle's characteristics will be accounted for in all route suggestions or that you will receive the warning icons in all cases. Limitations may exist in the map data such that your device cannot account for these restrictions or road conditions in all cases. Always defer to all posted road signs and road conditions when making driving decisions.

Warning and alert symbols may appear on the map or in route directions to alert you to potential hazards, road conditions, and upcoming weigh stations.

Restriction Warnings

	Height
	Weight
	Axle Weight
	Length
	Width
	No Trucks Allowed
	No Trailers Allowed
	Material Restrictions
	No Flammables or Explosives Allowed
	No Water Pollutants Allowed
	No Left Turn
	No Right Turn
	No U Turn

Road Condition Warnings

	Risk of grounding
	Lateral wind
	Narrow road
	Sharp curve
	Steep down hill
	Steep up hill
	Tree overhang

Alerts

	Weigh station
	Road not verified for trucks

Trip Information

Viewing Trip Data from the Map

From the map, select  > **Trip Data**.

Customizing the Trip Data Fields

- 1 From the map, select  > **Trip Data**.
- 2 Select a trip data field.
- 3 Select an option.

The new trip data field appears in the trip data map tool.

Viewing Your Trip History

Your device keeps a record of the path you have traveled.

- 1 Select  > **Map > Map Layers**.
- 2 Select the **Travel History** check box.

Resetting Trip Information

- 1 From the map, select **Speed**.
- 2 Select a trip information data field.
- 3 Select  > **Reset Field(s)**.
- 4 Select an option:
 - When not navigating a route, select **Select All** to reset every data field except the speedometer, on the first page.
 - Select **Reset Overall Data** to reset Trip A and total data.
 - Select **Reset Max. Speed** to reset the maximum speed.
 - Select **Reset Trip B** to reset the odometer.

Viewing Upcoming Traffic

NOTICE

Garmin is not responsible for the accuracy or timeliness of the traffic information.

Before you can use this feature, your device must be receiving traffic data ([Traffic](#), page 37).

You can view traffic incidents coming up along your route or along the road on which you are traveling.



- 1 While navigating a route, select  > **Traffic**.

The nearest upcoming traffic incident appears in a panel on the right side of the map.



- 2 Select the traffic incident to view additional details.

Viewing Traffic on the Map

The traffic map shows color-coded traffic flow and delays on nearby roads.

- 1 From the main menu, select  > **Traffic**.
- 2 If necessary, select  > **Legend** to view the legend for the traffic map.

Searching for Traffic Incidents

- 1 From the main menu, select  > **Traffic**.
- 2 Select  > **Incidents**.
- 3 Select an item in the list.
- 4 If there is more than one incident, use the arrows to view additional incidents.

Customizing the Map

Customizing the Map Layers

You can customize which data appear on the map, such as icons for points of interest and road conditions.

- 1 Select  > **Map** > **Map Layers**.
- 2 Select the layers to include on the map, and select **Save**.

Changing the Map Data Field

- 1 From the map, select a data field.
NOTE: You cannot customize Speed.
- 2 Select a type of data to display.

Changing the Map Perspective

- 1 Select  > **Map** > **Driving Map View**.
- 2 Select an option:
 - Select **Track Up** to display the map in two dimensions (2-D), with your direction of travel at the top.
 - Select **North Up** to display the map in 2-D with north at the top.
 - Select **3-D** to display the map in three dimensions.
- 3 Select **Save**.

Live Services, Traffic, and Smartphone Features

WARNING

Do not read or interact with notifications while driving, because doing so can cause distraction that could lead to an accident resulting in serious personal injury or death.

The dēzl app allows your device to receive smart notifications and live information, such as live traffic data and weather information.

Live traffic data: Sends real-time traffic data to your device, such as traffic incidents and delays, construction zones, and road closings ([Traffic, page 37](#)).

Weather information: Sends real-time weather forecasts, road conditions, and weather radar to your device ([Viewing the Weather Forecast, page 44](#)).

Smart Notifications: Displays phone notifications and messages on your device. This feature is not available for all languages.

Hands-Free calling: Allows you to place and receive phone calls using your device, and allows you to use the device as a hands-free speaker phone. If the selected language supports the voice command feature, you can place calls using voice commands.

Send locations to device: Allows you to send locations from your smartphone to your navigation device.

Pairing with Your Smartphone

You can pair your dēzl device with your smartphone and the dēzl app to enable additional features and access live information (*Live Services, Traffic, and Smartphone Features, page 34*).

- 1 From the app store on your smartphone, install the dēzl app.
- 2 Turn on your dēzl device, and place the device and your smartphone within 3 m (10 ft.) of each other.
- 3 On your phone, open the dēzl app.
- 4 Follow the on-screen instructions to sign in to a Garmin account and complete the pairing and setup process.

The main app dashboard appears. After the devices are paired, they connect automatically when they are turned on and within range.

Going to an Address or Location Using the dēzl App

You can use the dēzl app to search for an address, business, or point of interest, and send it to your dēzl device for navigation.

- 1 From the dēzl app, select **Where To?**.
- 2 Select an option:
 - To search for an address near you, enter the house number and street name.
 - To search for an address in another city, enter the house number, street name, city, and state.
 - To search for a business name, enter all or part of the name.
 - To search for a city, enter the city and state.

As you type, suggestions appear below the search field.

- 3 Select a suggested search result.

The app displays the location on a map.

- 4 Select **Send to Device** to start a route.

The dēzl device starts navigating to the selected location, and the location is added to your recent searches in the Where To? menu.

Smart Notifications

While your device is connected to the dēzl app, you can view notifications from your smartphone on your dēzl device, such as text messages, incoming calls, and calendar appointments.



Receiving Notifications while Viewing the Map

WARNING

Do not read or interact with notifications while driving, because doing so can cause distraction that could lead to an accident resulting in serious personal injury or death.

Before you can use this feature, your device must be connected to a supported phone running the dēzl app.

When you are viewing the map, new notifications appear in a map tool at the edge of the screen. If the device is moving, you must verify you are a passenger and not the driver before you can view notifications.

- To ignore a notification, select , or wait for popup to expire.
The popup closes, but the notification remains active on your phone.
- To view a notification, select the notification text.
- To listen to the notification, select .

The device reads the notification using text-to-speech technology. This feature is not available for all languages.

Hands-Free Calling

NOTE: While most phones are supported and can be used, it cannot be guaranteed that a particular phone can be used. All features may not be available for your phone.

Using Bluetooth wireless technology, your device can connect to your mobile phone to become a hands-free device (*Pairing with Your Smartphone, page 35*). While connected, you can place or receive calls using your device.

Enabling Hands-Free Calling

Before you can enable hands-free calling features, you must pair your dēzl navigator with the dēzl app on a compatible phone (*Pairing with Your Smartphone, page 35*).

- 1 Select  > **Phone**.
- 2 Select your paired phone.
- 3 Select **Phone calls**.

Placing a Call

- 1 Select  > **Phone**.
- 2 Select an option:
 - To dial a number, select **Dial**, enter the phone number, and select **Dial**.
 - To view numbers of recent, missed, or recently dialed or received calls, select **Call History**, select a log, select a number, and select **Call** to dial it.
 - To call a contact from your phone book, select **Phone Book**, select a contact, and select **Call**.
 - To call a point of interest location such as a restaurant or attraction, select **Browse Categories**, select a category, select a location, and select **Call**.

Calling Home

Before you can call home, you must enter a phone number for your home location.

Select  > **Phone** > **Call Home**.

Placing a Call Using Voice Dial



- 1 Select  > **Phone** > **Voice Dial**.
- 2 Listen for the voice prompt.
- 3 Say **Call**, and say the contact name, phone number, or location you want to call.

Receiving a Call

When you receive a call, select **Answer** or **Dismiss**.

Using In-Call Options

In-call options appear on the map when you answer a call. Some options may not be compatible with your phone.

TIP: If you close the in-call options page, you can open it again by selecting  from any screen. You can also select  >  from the map.

- To set up a conference call, select **Add Call**.
- To transfer audio to your phone, select **Call in Progress on Navigator**.

TIP: You can use this feature if you want to disconnect the Bluetooth connection and remain on the call, or if you need privacy.
- To use the dial pad, select **Keypad**.

TIP: You can use this feature to use automated systems, such as voice mail.
- To mute the microphone, select **Mute**.
- To hang up, select **End Call**.

Enabling or Disabling Bluetooth Features

You can enable or disable Bluetooth features such as phone calls, media audio, and live services for your paired smartphone.

- 1 Select  > **Phone**.
- 2 Select your phone name.
- 3 Select a feature to enable or disable it.

Showing or Hiding App Notifications

You can use the dēzl app to customize which types of smartphone notifications appear on your dēzl device.

- 1 On your phone, open the dēzl app.
- 2 Select  > **Smart Notifications**.
A list of smartphone app categories appears.
- 3 Select a category to enable or disable notifications for that type of app.

Disconnecting a Bluetooth Device

You can temporarily disconnect a Bluetooth device without deleting it from the paired devices list. The Bluetooth device can connect to your dēzl device automatically in the future.

- 1 Select  > **Phone**.
- 2 Select the device to disconnect.
- 3 Select **Disconnect**.

Deleting a Paired Phone

You can delete a paired phone to prevent it from automatically connecting to your device in the future.

- 1 Select  > **Phone**.
- 2 Select the phone, and select **Forget Device**.

Traffic

NOTICE

Garmin is not responsible for the accuracy or timeliness of the traffic information.

Your device can provide information about traffic on the road ahead or on your route. You can set your device to avoid traffic when calculating routes, and to find a new route to your destination if a large traffic delay occurs on your active route (*Traffic Settings, page 52*). The traffic map allows you to browse the map for traffic delays in your area.

To provide traffic information, your device must be receiving traffic data.

- All product models can receive subscription-free traffic data using the dēzl app (*Receiving Traffic Data Using Your Smartphone, page 37*).

Traffic data is not available in all areas. For information about traffic coverage areas, go to garmin.com/traffic.



Receiving Traffic Data Using Your Smartphone

Your device can receive subscription-free traffic data while connected to a smartphone running the dēzl app.



- 1 Connect your device to the dēzl app.
- 2 On your dēzl device, select  > **Traffic** > **Traffic**, and verify the **Garmin Live Traffic** option is selected.

Viewing Traffic on the Map

The traffic map shows color-coded traffic flow and delays on nearby roads.

- 1 From the main menu, select  > **Traffic**.
- 2 If necessary, select  > **Legend** to view the legend for the traffic map.

Searching for Traffic Incidents

- 1 From the main menu, select  > **Traffic**.
- 2 Select  > **Incidents**.
- 3 Select an item in the list.
- 4 If there is more than one incident, use the arrows to view additional incidents.

Vehicle and Driver Tools

Break Planning

NOTICE

This device by itself is NOT an approved substitute for logbook recording requirements under Federal Motor Carrier Safety Administration (FMCSA) regulations. Drivers should comply with all applicable federal and state hours-of-service requirements. When integrated with a Garmin eLog compliant Electronic Logging Device (ELD), the Garmin eLog device enables a motor carrier to comply with hours of service logging and break requirements. For more information, or to purchase a Garmin eLog device, go to garmin.com/elog.

When the break planning feature is enabled, the device notifies you one hour before suggested break times and drive hour limits and suggests break locations on your route. You can use this feature to keep track of your working hours, which may help you comply with safety regulations.

NOTE: Break planning features are not available when using the car vehicle profile.

Taking a Suggested Break

When it is time for a break, the device notifies you and displays suggested break location POIs along your route.

Select a POI from the list of suggested break locations.

The device adds the break location as the next destination on your route.

Starting the Break Timer

The break timer starts automatically when the vehicle is moving at least 8 kph (5 mph) for 30 seconds. You can start the timer manually at any time.

- 1 From the map, select  > **Break Planner**.
- 2 Select **Start Timer**.

Pausing and Resetting the Break Timer

The break timer pauses automatically when the vehicle stops for three minutes or longer. You can pause the timer manually for brief stops, such as parking or stopping at a truck stop. At the end of your drive, you can manually reset the timer.

- 1 Select **Stop Timer**.
- 2 Select an option:
 - To pause the timer, select **Pause**.
 - To stop and reset the timer, select **Reset**.

Adjusting Drive Hours

You can adjust your total hours driven to more closely match your hours of service records.

- 1 While using the break planner feature, select **Total Hours Driven**.
- 2 Enter the total hours driven.
- 3 Select **Save**.

Garmin eLog

The Garmin eLog adapter enables a motor carrier to comply with hours of service logging and break requirements. When a Garmin eLog adapter is paired with your compatible mobile device, you can view hours of service information on your dēzl device. The Garmin eLog adapter is not available in all areas. For more information, or to purchase a Garmin eLog adapter, go to garmin.com/elog.

NOTE: Garmin eLog features are not available when using the car vehicle profile.

Setting Up Garmin eLog Features On Your dēzl Device

- 1 Pair your Garmin eLog adapter with the Garmin eLog app on your mobile device (*Setting Up Your Garmin eLog Device, page 39*).
- 2 Pair your dēzl device with your compatible mobile device.
- 3 Enable the Garmin eLog app to pair with a dēzl device (*Enabling the Garmin eLog App to Pair with a dēzl Device, page 39*).
- 4 If necessary, enable the Garmin eLog connection on your dēzl device (*Enabling or Disabling the Garmin eLog Connection on Your dēzl Device, page 39*).

Setting Up Your Garmin eLog Device

You must set up and pair your Garmin eLog adapter with the Garmin eLog app in order to use the device.

- 1 From the app store on your mobile device, install and open the  Garmin eLog app.
- 2 On your mobile device, follow the on-screen instructions to set up and configure the Garmin eLog system.

NOTE: Until you complete the setup process, the device has limited functionality.

Enabling the Garmin eLog App to Pair with a dēzl Device

- 1 From the Garmin eLog app, log in to a driver profile.
- 2 Select **Settings > Pair to Nearby Garmin dēzl**.

Enabling or Disabling the Garmin eLog Connection on Your dēzl Device

- 1 From your dēzl device, select  > **Phone**.
- 2 Select the name of your paired mobile device.
- 3 Select or clear the **Garmin eLog Adapter** check box.

Viewing Garmin eLog Information on Your dēzl Device

Before you can view Garmin eLog information on your dēzl device, you must complete the setup process (*Setting Up Your Garmin eLog Device, page 39*).

As you drive your vehicle, the device displays your duty status and total drive hours in the Garmin eLog map tool.

Select a field to view a summary of remaining drive hours.

Viewing Garmin eLog Diagnostic and Malfunction Events

When the Garmin eLog device detects a diagnostic or malfunction event, it displays a notification on the device screen.

Select the diagnostic or malfunction notification to view details about the event.

NOTE: You can view additional information about diagnostic and malfunction events in the Garmin eLog app.

IFTA

NOTE: This feature is not available in all areas.



Before you can use this feature, a truck vehicle profile must be active.

You can record data needed for International Fuel Tax Agreement documentation (IFTA), such as fuel-purchase data and miles driven.

Entering Fuel Data



- 1 Select  > **IFTA** > **At the Pump**.
- 2 Enter the fuel price per gallon.
- 3 Select the **Fuel Used** field.
- 4 Enter the amount of fuel purchased.
- 5 If necessary, select the fuel type:
 - To record the amount in liters, select **Gallons** > **Liters** > **Save**.
 - To record the amount in gallons, select **Liters** > **Gallons** > **Save**.
- 6 If necessary, select the **Tax Included** check box.
- 7 Select **Next**.
- 8 Select an option to record the fuel station where you refueled:
 - Select a nearby fuel station from the list.
 - Select the text field, and enter the fuel station name and address.
- 9 Select the fuel purchaser.

Editing Fuel Data

- 1 Select  > **IFTA** > **Fuel Journals**.
- 2 If necessary, select a vehicle profile.
- 3 If necessary, select a quarter.
- 4 Select a fuel record.
- 5 Select an option:
 - Select a field to edit the information.
 - Select  to delete the record.





Viewing and Exporting a Jurisdiction Summary

The jurisdiction summary lists data for each state or province in which your vehicle has operated during each quarter. The jurisdiction summary is available in some areas.

- 1 Select  > **IFTA** > **Jurisdiction Summary**.
- 2 If necessary, select a truck.
- 3 If necessary, select a quarter.
- 4 Select  > **Export** > **OK** to export a jurisdiction summary.

The device exports the summary to a .csv file and stores it in the Reports folder on the device.

Editing and Exporting Trip Reports

- 1 From the main menu, select  > **IFTA** > **Trip Reports**.
- 2 If necessary, select a truck.
- 3 If necessary, select a quarter.
- 4 Select a report.
- 5 Select an option:
 - Select  > **Delete**, and select the check box to delete a report.
 - Select  > **Combine**, and select the check boxes to combine reports.
 - Select  > **Export** > **OK**. The device exports the report to a .csv file and stores it in the **Reports** folder on the device.

Viewing Exported Jurisdiction Summaries and Trip Reports

NOTICE

If you do not know the purpose of a file, do not delete it. Your device memory contains important system files that should not be deleted.



- 1 Connect the device to your computer.
- 2 From the file browser on your computer, browse to the internal device storage, and open the **Reports** folder.
- 3 Open the **IFTA** folder.
- 4 Open the .csv file.

Logging Service History

You can log the date and odometer reading when service or maintenance is performed on your vehicle. The device provides several service categories, and you can add custom categories ([Adding Service Categories, page 41](#)).



- 1 Select  > **Service History**.
- 2 Select a service category.
- 3 Select **Add Record**.
- 4 Enter the odometer reading, and select **Next**.
- 5 Enter a comment (optional).
- 6 Select **Done**.

Adding Service Categories



- 1 Select  > **Service History**.
- 2 Select  > **Add Category**.
- 3 Enter a category name, and select **Done**.

Deleting Service Categories



When you delete a service category, all service records in the category are also deleted.

- 1 Select  > **Service History**.
- 2 Select  > **Delete Categories**.
- 3 Select the service categories to delete.
- 4 Select **Delete**.

Renaming Service Categories

- 1 Select  > **Service History**.
- 2 Select the category to be renamed.
- 3 Select  > **Rename Category**.
- 4 Enter a name, and select **Done**.

Deleting Service Records

- 1 Select  > **Service History**.
- 2 Select a service category.
- 3 Select  > **Delete Records**.
- 4 Select the service records to be deleted.
- 5 Select **Delete**.

Editing a Service Record

You can edit the comment, odometer reading, and date of a service record.

- 1 Select  > **Service History**.
- 2 Select a category.
- 3 Select a field.
- 4 Enter the new information, and select **Done**.

PrePass[®]

NOTICE

Garmin is not responsible for the accuracy or timeliness of the information provided by the PrePass app.

NOTE: Before you can use this feature, you must have an active PrePass account.

The PrePass app enables drivers to verify the safety, credentials, and weight of a commercial vehicle with upcoming weigh stations. You can pair your dēzl device with the dēzl app and the PrePass app to receive upcoming weigh station notifications on your dēzl device.

NOTE: This feature is available only in the United States.

Loyalty Programs



From your dēzl device, you can access loyalty programs from some of the travel plazas in the United States, including Love's Travel Stops and Pilot Flying J Travel Centers. You can use the loyalty program apps on your dēzl device to check reward points balances and other loyalty program information. To activate loyalty program features, sign in to your loyalty program account in the dēzl app.

NOTE: This feature is available only in the United States.

Using the Apps

Viewing the Owner's Manual on Your Device

You can view the complete owner's manual on the device screen in many languages.

- 1 Select  > **Owner's Manual**.
The owner's manual appears in the same language as the software text ([System Settings](#), page 53).
- 2 Select  to search the owner's manual (optional).

Viewing the Truck Map

The truck map highlights recognized truck routes on the map, such as the Surface Transportation Assistance Act (STAA) preferred routes, TruckDown (TD) preferred routes, and non-radioactive hazardous materials (NRHM) routes. The recognized routes vary based on your area and the map data loaded on your device.

Select  > **Truck Map**.



Route Planner

You can use the route planner to create and save a route, which you can navigate later. This can be useful for planning a delivery route, a vacation, or a road trip. You can edit a saved route to further customize it, including reordering locations, adding suggested attractions, and adding shaping points.





You can also use the route planner to edit and save your active route.

Planning a Route

A route can include many locations, and it must include at least a starting location and one destination. The starting location is the location from which you plan to start your route. If you start navigating the route from a different location, the device gives you the option to route to your starting location first. For a round trip, the starting location and final destination can be the same.

- 1 Select  > **Route Planner** > **Create Route**.
- 2 Select **Select Start Location**.
- 3 Choose a location for your starting point, and select **Select**.
- 4 Select **Select Destination**.
- 5 Choose a location for a destination, and select **Select**.
- 6 Select **Add Location** to add more locations (optional).
- 7 After you have added all the necessary locations, select **Next** > .
- 8 Enter a name, and select **Done**.

Editing and Reordering Locations in a Route

- 1 Select  > **Routes**.
- 2 Select a saved route.
- 3 Select **List**.
- 4 Select a location.
- 5 Select an option:
 - To change the location, select , and enter a new location.
 - To move the location up or down, select , and drag the location to a new position in the route.
 - To add a new location after the selected location, select .
 - To remove the location, select .

Navigating to a Saved Route

- 1 Select  > **Route Planner**.
- 2 Select a saved route.
- 3 Select **Go!**.
- 4 Select the first location to navigate to, and select **OK**.
- 5 Select **Start**.

The device calculates a route from your current location to the selected location, and then it guides you to the remaining route destinations in order.

Editing and Saving Your Active Route

If a route is active, you can use the route planner to edit and save it.

- 1 Select  > **Route Planner** > **My Active Route**.
- 2 Edit your route using any of the route planner features.

The route recalculates each time you make a change.
- 3 Select **Save** to save your route, which you can navigate again later (optional).

Viewing Previous Routes and Destinations

Before you can use this feature, you must enable the travel history feature ([Device Settings and Product Information](#), page 53).

You can view your previous routes and places you have stopped on the map.

Select  > **Trip History**.

Viewing the Weather Forecast

Before you can use this feature, your device must be receiving weather data. You can connect your device to the dēzl app to receive weather data.

- 1 Select  > **Weather**.

The device shows the current weather conditions and a forecast for the next several days.

- 2 Select a day.

The detailed forecast for that day appears.

Viewing the Weather Radar

Before you can use this feature, your device must be connected to a supported phone running the dēzl app ([Pairing with Your Smartphone, page 35](#)).

Select  > **Weather** > **Radar**.



Viewing the Wind Forecast

- 1 Select  > **Weather** > **Wind**.

- 2 Select an option:

- To view a map of the average wind speed forecast in your area, select **Wind Speed**.
- To view a map of the strongest wind speeds forecast in your area, select **Wind Gust**.

Viewing Weather Near a Different City

- 1 Select  > **Weather** > .

- 2 Select an option:

- To view weather for a favorite city, select a city in the list.
- To add a favorite city, select **Add City**, and enter a city name.

Music Player

The music player allows your device to control the music currently playing from a media app on your paired phone. You can open the media player at any time by selecting Music from the main menu.

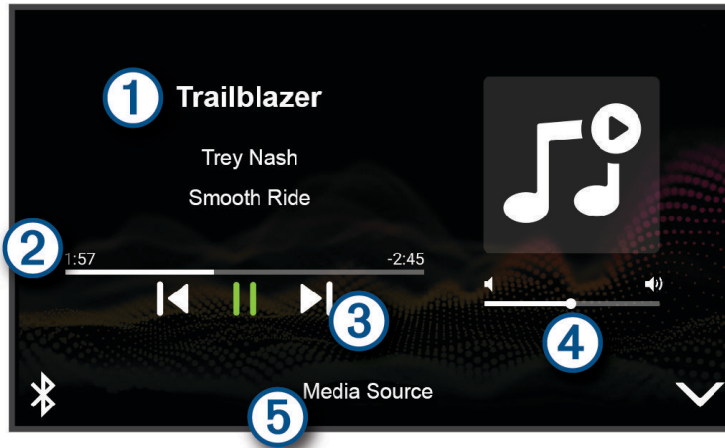

- | | |
|---|---|
| ① | Information about the currently playing media, such as title, artist, album, station, or channel. |
| ② | Progress through the current media item. |
| ③ | Playback controls. The controls change based on the source providing the media. |
| ④ | Volume controls. You can use the slider to adjust the volume. |
| ⑤ | The name of the connected media source. |



Adding the Music Player Tool to the Map

The music player map tool enables you to control the music player from your map.

- 1 Open the map.
- 2 Select  > **Music Controls**.
The music player controls appear on the map.

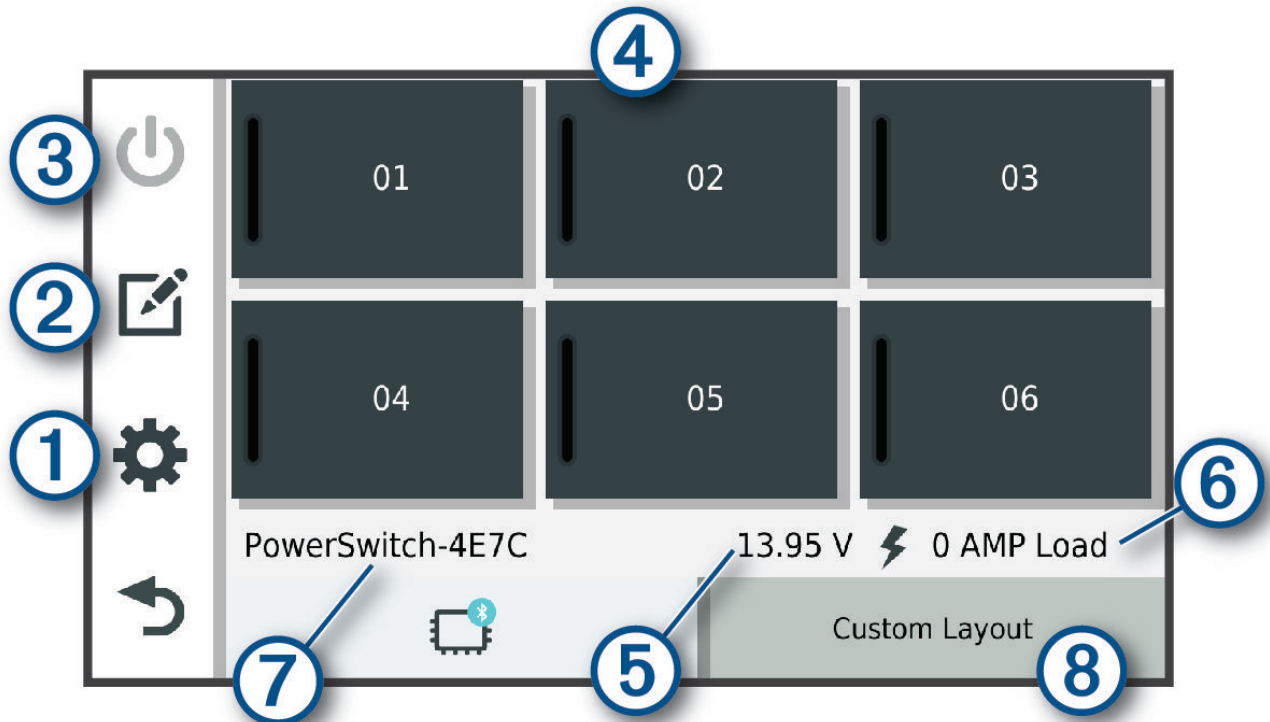
Garmin PowerSwitch™ App



① 	Opens the app settings menu
② 	Enters editing mode to customize the app layout and functions
③ 	Turns off all outputs
④ Power buttons	Activates each connected output
⑤	Displays input voltage
⑥	Displays the total amperage of the selected Garmin PowerSwitch device
⑦	Displays the device name
⑧	Displays Garmin PowerSwitch device tabs and custom layout tabs

Activating a Power Switch



Before you can use the Garmin PowerSwitch app to activate a switch, you must install your Garmin PowerSwitch device in your vehicle and pair it with the Garmin PowerSwitch app.

From the Garmin PowerSwitch app, select a power button to turn a switch on or off.

Turning Off All Switches

Select .

Customizing a Button

- 1 From the Garmin PowerSwitch app screen, select .
The app enters editing mode.
- 2 Select  on the button you want to customize.
- 3 Select an option:
 - To change the name of the button, select the **Button Label** field, and enter a name.
 - To add an icon to the button, select the **Icon** field, and select an icon.
 - To change the button color, select a color.
 - To change the button mode, select a button mode.
 - To adjust the intensity of the switch, use the slider.
 - To set the button to activate with a control input, select a control input.
- 4 Select .
- 5 Select **Done**.

Assigning a Switch to a Control Input



Before you can use control input functions, you must connect a control input to your Garmin PowerSwitch device.

You can assign one or more switches to turn on when the Garmin PowerSwitch device receives a signal from a control input.



- 1 Select .
- 2 Select your Garmin PowerSwitch device.
- 3 Select a control input.
- 4 Select one or more switches.

Adding a Custom Layout



You can add a custom layout tab to the Garmin PowerSwitch app. Buttons added to a custom layout can control multiple switches at the same time.

- 1 From the Garmin PowerSwitch app, select .
The device enters editing mode.
- 2 Select .



Adding a Button to a Custom Layout

- 1 From the Garmin PowerSwitch app, select a custom layout tab.
- 2 Select .
The app enters editing mode.
- 3 Select **Add Button**.
- 4 On the new button, select .
- 5 Select an option:
 - To change the name of the button, select the **Button Label** field, and enter a name.
 - To add an icon to the button, select the **Icon** field, and select an icon.
 - To change the button color, select a color.
- 6 Select **Add Action**.
- 7 If necessary, select a Garmin PowerSwitch device and a switch.
- 8 Select an action:
 - To set the button to turn the switch on or off with each press, select **Toggle**.
 - To set the button to turn on the switch, select **Turn On**.
 - To set the button to turn off the switch, select **Turn Off**.
- 9 Select a button mode:
 - To set the button to activate with one touch, select **Normal**.
 - To set the button to activate only while touching the button, select **Momentary**.
 - To set the button to turn on and off repeatedly, select **Strobe**, and select time intervals.
- 10 If applicable, use the slider to set the brightness of lights.
- 11 Select .
- 12 If necessary, select **Add Action** to add additional actions for the button.
You can add one action for every switch on the Garmin PowerSwitch device.

Arranging Buttons In a Custom Layout

- 1 From the Garmin PowerSwitch app, select a custom layout tab.
- 2 Select .
The app enters editing mode.
- 3 On the button you want to move, hold  and drag the button to a new location.

Deleting a Custom Layout or Button

- 1 From the Garmin PowerSwitch app, select a custom layout tab.
- 2 Select .
The app enters editing mode.
- 3 Select an option:
 - To delete a button, select  on the button you want to delete.
 - To delete a layout tab, select  on the layout tab.



Routines

Routines automate your Garmin PowerSwitch device. When you define a routine on your compatible Garmin navigation device, it turns switches on or off automatically when the conditions of the routine are met. For example, you can set a routine to turn on a switch at specific time each day or when your vehicle reaches a specific speed. Routines are available only when using a compatible Garmin navigation device.



Adding a Routine

- 1 From the Garmin PowerSwitch app, select  > **Routines**.
- 2 If necessary, select **Add Routine**.
- 3 Select **When**.
- 4 Select a trigger:
 - To set a switch to trigger when your vehicle reaches a specific speed, select **Speed** > **Next**, and follow the on-screen instructions to enter speed thresholds.
 - To set a switch to trigger at a specific time each day, select **Time** > **Next**, and enter a time.
 - To set a switch to trigger at sunrise, select **Sunrise**.
 - To set a switch to trigger at sunset, select **Sunset**.
- 5 Select **Add Action**.
- 6 Select a device, a switch, an action, and a button mode.
- 7 If necessary, use the slider to adjust the dimmer.
- 8 Select **Save**.

Editing a Routine

- 1 From the Garmin PowerSwitch app, select  > **Routines**.
- 2 Select  on the routine you want to edit.
- 3 Select an option:
 - To change the trigger for the routine, select **When**, and select a trigger.
 - To change an action, select  on the action you want to change, and update the action.
 - To add an action to the routine, select **Add Action**, and enter information about the action.
- 4 Select **Save**.

Deleting a Routine

- 1 From the Garmin PowerSwitch app, select  > **Routines**.
- 2 Select  on the routine you want to delete.

Voice Command

NOTE: Voice command is not available for all languages and regions, and may not be available on all models.

NOTE: Voice Activated Navigation may not achieve desired performance when in a noisy environment.

Voice command allows you to use your device by saying words and commands. The voice command menu provides voice prompts and a list of available commands.

Tips for Speaking to the Device

- Speak in a clear voice directed at the device.
- Start each request with *OK, Garmin*.
- Reduce background noise, such as voices or the radio, to help the device interpret your commands more accurately.
- Respond to voice prompts from the device as needed.
- If you do not receive a useful response, try rephrasing your request.
- If the device does not respond to your requests, verify it is not placed near a speaker or air vent, which can produce noise that interferes with the microphone.

Launching Garmin Voice-Activated Navigation

Garmin voice-activated navigation allows you to use plain language spoken requests to search for locations and addresses, start routes with turn-by-turn directions, place hands-free phone calls, and more.

- Say *OK, Garmin*, and make a spoken request.
For example, you can say phrases like these:
 - *OK, Garmin, take me home.*
 - *OK, Garmin, where's the library?*

Checking Your Arrival Time

While a route is active, you can say a phrase to check your estimated time of arrival at your destination.

Say *OK, Garmin, what time will we arrive?*.

Placing a Phone Call Using Your Voice

You can use a voice command to call to a contact from the phone book of your paired smartphone.

Say *OK, Garmin, call*, and say the contact name.

For example, you can say *OK, Garmin, call Mom..*

Changing Device Settings Using Your Voice

You can say phrases like these to set device settings to a value from 0 to 10.

- *OK, Garmin, increase the volume.*
- *OK, Garmin, set the volume to 0.*
- *OK, Garmin, set the volume to 9.*
- *OK, Garmin, decrease the brightness.*
- *OK, Garmin, set the brightness to 5.*

Settings

Phone Settings

Select  > **Phone**, and select your phone.

Disconnect: Disconnects the paired phone.

Phone Name: Displays the name of the paired phone. You can select the name to change how it appears on your navigation device.

Phone calls: Enables the navigation device to control calls on your paired phone.

Garmin dēzl: Appears when the navigation device is connected to the dēzl app on your phone.

Garmin eLog Adapter: Displays the status of your paired Garmin eLog adapter. This setting is not available in all areas.

Forget Device: Removes the connected device from the list of paired devices. This option is available only after a device is paired.

Wi-Fi Settings

The wireless network settings allow you to manage Wi-Fi networks.

Select  > **Wi-Fi**.

Wi-Fi: Enables the Wi-Fi radio.

Saved Networks: Allows you to edit or remove saved networks.

Search for Networks: Searches for nearby Wi-Fi networks ([Connecting to a Wireless Network, page 51](#)).

Connecting to a Wireless Network

The first time you turn on the device, it prompts you to connect to a Wi-Fi network and register your device. You can also connect to a Wi-Fi network using the settings menu.

- 1 Select  > **Wi-Fi**.
- 2 If necessary, select **Wi-Fi** to enable Wi-Fi technology.
- 3 Select **Search for Networks**.
The device displays a list of nearby Wi-Fi networks.
- 4 Select a wireless network.
- 5 If necessary, enter the password for the network, and select **Done**.

The device connects to the wireless network. The device remembers the network information and connects automatically when you return to this location in the future.

Map and Vehicle Settings

Select  > **Map**.

Map Vehicle Icon: Sets the vehicle icon that represents your position on the map.

Driving Map View: Sets the perspective on the map.

Map Detail: Sets the level of detail on the map. More detail may cause the map to draw slower.

Map Layers: Sets the data that appears on the map page (*Customizing the Map Layers, page 34*).

Waypoint Labels: Sets the size of waypoint labels on the map.

Waypoint Decluttering: Hides waypoint icons at high map zoom levels.

Auto Zoom: Automatically selects the zoom level for optimal use of your map. When disabled, you must zoom in or out manually.

myMaps: Sets which installed maps the device uses.

Enabling Maps

You can enable map products installed on your device.

TIP: To purchase additional map products, go to garmin.com/maps.

- 1 Select  > **Map** > **myMaps**.
- 2 Select a map.

Navigation Settings

Select  > **Navigation**.

Calculation Mode: Sets the route calculation method.

Avoidances: Sets road features to avoid on a route.

Custom Avoidances: Allows you to avoid specific roads or areas.

Traffic: Sets options for traffic features.

Environmental Zones: Sets the avoidance preferences for areas with environmental or emissions restrictions that may apply to your vehicle.

Restricted Mode: Disables all functions that require significant operator attention.

GPS Simulator: Stops the device from receiving a GPS signal, and saves battery power.

Traffic Settings

From the main menu, select  > **Navigation** > **Traffic**.

Traffic: Enables the traffic feature.

Current Provider: Sets the provider to use for traffic data. The Auto option selects the best available traffic data automatically.

Subscriptions: Lists the current traffic subscriptions.

Optimize Route: Enables the device to use optimized alternate routes automatically or upon request (*Avoiding Traffic Delays on Your Route, page 27*).

Driver Assistance Settings

Select  > **Driver Assistance**.

Driver Alerts: Allows you to enable or disable alerts for upcoming zones or road conditions (*Driver Awareness Features and Alerts, page 12*).

Speeding Alert: Alerts you when you are exceeding the speed limit.

Reduced Speed Tone: Alerts you when the speed limit decreases.

Country Border Alert: Displays a notification when crossing international borders.

Route Preview: Displays a preview of the major roads in your route when you start navigation.

Break Planning: Reminds you to take a break, and displays upcoming services after you drive for an extended time. You can enable or disable break reminders and upcoming service suggestions.

Proximity Alerts: Alerts you when you approach speed cameras or red light cameras.

Plan Arrival: Displays a map of your destination at the end of a route. You can also enable your device to download satellite imagery using the mobile data on your paired smartphone.

Wireless Camera Settings

The wireless camera settings allow you to manage paired Garmin wireless cameras and camera settings. Settings in this menu only appear when a wireless camera is connected to your dēzl device. See the manual for your wireless camera for more information about pairing a wireless camera with your dēzl device.

Display Settings

Select  > **Display**.

Orientation: Allows you to set the display to portrait (vertical) or landscape (horizontal).

NOTE: This feature is not available on all product models.

Color Mode: Allows you to select day or night color mode. If you select the Auto option, the device automatically switches to day or night colors based on the time of day.

Brightness: Allows you to adjust the display brightness.

Display Timeout: Allows you to set the amount of idle time before your device enters sleep mode while using battery power.

Screenshot: Allows you to take a picture of the device screen. Screenshots are saved in the Screenshot folder of the device storage.

System Settings

Select  > **System**.

Voice Language: Sets the language for voice prompts.

Text Language: Sets all on-screen text to the selected language.

NOTE: Changing the text language does not change the language of user-entered data or map data, such as street names.

Keyboard Language: Enables keyboard languages.

Units: Sets the unit of measure used for distances.

Current Time: Sets the device time.

Time Format: Allows you to select a 12-hour, 24-hour, or UTC display time.

Position Format: Sets the coordinate format and datum used for geographical coordinates.

Device Settings and Product Information

Select  > **Device**.

About: Displays hardware and software version information.

Regulatory: Displays e-label regulatory and compliance information.

EULAs: Allows you to view the end-user license agreement (EULA) and software license information.

Software Licenses: Displays software license information.

Device Data Reporting: Shares data to improve the device.

Travel History: Allows the device to store a record of the places you go. This allows you to view the trip log and use other trip history features.

Reset: Allows you to clear your travel history, reset settings, or delete all user data.

Resetting Data and Settings

The device offers several options for deleting your user data and resetting all settings to the factory default values.

1 Select  > **Device** > **Reset**.

2 Select an option:

- To clear your travel history, select **Clear Travel History**.

This option deletes all records of the places you have traveled. It does not delete saved locations or installed maps.

- To reset all settings to the factory default values, select **Reset Default Settings**.

This option does not delete any user data.

- To delete all user data and reset all settings to the factory default values, select **Delete Data and Reset Settings**.

This option deletes all user data, including your saved locations, recently found locations, and travel history. Installed maps are not deleted.

Restoring Settings

You can restore a category of settings or all settings to the factory default values.

1 Select .

2 If necessary, select a settings category.

3 Select  > **Restore**.

Device Information

Viewing E-label Regulatory and Compliance Information

- 1 From the settings menu, swipe to the bottom of the menu.
- 2 Select **Device > Regulatory**.

Specifications

Operating temperature range	From -20° to 60°C (from -4° to 131°F)
Charging temperature range	From 0° to 45°C (from 32° to 113°F)
Power input	Vehicle power using the included vehicle power cable. AC power using an optional accessory (for home and office use only).
Battery type	Rechargeable lithium-ion
Radio frequency (dēzl OTR820 / LGV820)	2.4 Ghz @ 15 dBm maximum 5.1 Ghz @ 21 dBm maximum 5.7 Ghz @ 7.5 dBm maximum
Radio frequency (dēzl OTR1020 / LGV1020)	2.4 Ghz @ 15 dBm maximum 5.1 Ghz @ 19.5 dBm maximum 5.7 Ghz @ 8.2 dBm maximum
EU SAR (dēzl OTR820 / LGV820)	0.51 W/kg torso, 0.66 W/kg limb
EU SAR (dēzl OTR1020 / LGV1020)	0.40 W/kg torso, 0.51 W/kg limb

Charging the Device

NOTE: This Class III product shall be powered by an LPS power supply.

You can charge the battery in the device using any of these methods.

- Install the device in the mount, and connect the mount to vehicle power.
- Connect the device to an optional power adapter accessory, such as a wall power adapter.
You can purchase an approved Garmin AC-DC adapter suitable for home or office use from a Garmin dealer or www.garmin.com. The device may charge slowly when connected to a third-party adapter.

Device Maintenance

Garmin Support Center

Go to support.garmin.com for help and information, such as product manuals, frequently asked questions, videos, and customer support.

Updating Maps and Software Using a Wi-Fi Network

NOTICE

Map and software updates may require the device to download large files. Regular data limits or charges from your internet service provider apply. Contact your internet service provider for more information about data limits or charges.

You can update the maps and software by connecting your device to a Wi-Fi network that provides access to the internet. This allows you to keep your device up to date without connecting it to a computer.

- 1 Connect the device to a Wi-Fi network ([Connecting to a Wireless Network, page 51](#)).

While connected to a Wi-Fi network, the device checks for available updates. When an update is available,  appears on the  icon in the main menu.

- 2 Select  > **Updates**.

The device checks for available updates. When an update is available, **Update Available** appears below Map or Software.

- 3 Select an option:

- To install all available updates, select **Install All**.
- To install only map updates, select **Map > Install All**.
- To install only software updates, select **Software > Install All**.

- 4 Read the license agreements, and select **Accept All** to accept the agreements.

NOTE: If you do not agree with the license terms, you can select **Reject**. This stops the update process. You cannot install updates until you accept the license agreements.

- 5 Using the included USB cable, connect the device to external power, and select **Continue** ([Charging the Device, page 54](#)).

For the best results, a USB wall charger that provides at least 2 A power output is recommended. Many USB power adapters for smartphones, tablets, or portable media devices may be compatible.

- 6 Keep the device connected to external power and within range of the Wi-Fi network until the update process is complete.

TIP: If a map update is interrupted or canceled before it completes, your device may be missing map data. To repair missing map data, you must update the maps again using either Wi-Fi or Garmin Express.

Updating Maps and Software with Garmin Express

You can use the Garmin Express application to download and install the latest map and software updates for your device.

1 If you do not have the Garmin Express application installed on your computer, go to garmin.com/express and follow the on-screen instructions to install it (*Installing Garmin Express, page 57*).

2 Open the  Garmin Express application.

3 Connect your device to your computer using a USB cable.

The small end of the cable connects to the USB port **1** on your dēzl device, and the large end connects to an available USB port on your computer.

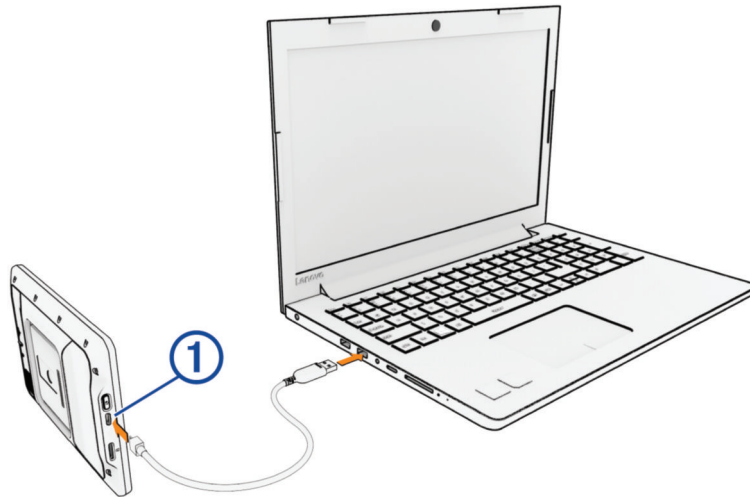

4 From your dēzl device, select **Tap to Connect to Computer**.

5 In the Garmin Express application, click **Add a Device**.

The Garmin Express application searches for your device and displays the device name and serial number.

6 Click **Add Device**, and follow the on-screen instructions to add your device to the Garmin Express application.

When setup is complete, the Garmin Express application displays the updates available for your device.

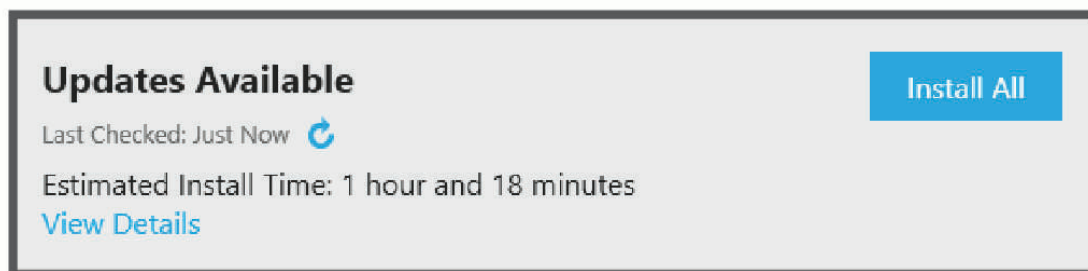

7 Select an option:

- To install all available updates, click **Install All**.
- To install a specific update, click **View Details**, and click **Install** next to the update you want.

The Garmin Express application downloads and installs the updates onto your device. Map updates are very large, and this process may take a long time on slower internet connections.

NOTE: If a map update is too large for the internal storage of the device, the software may prompt you to install a microSD® card in your device to add storage space (*Installing a Memory Card for Maps and Data*, page 67).

8 Follow the on-screen instructions during the update process to finish installing updates.

For example, during the update process, the Garmin Express application may instruct you to disconnect and reconnect your device.

Installing Garmin Express

The Garmin Express application is available for Windows® and Mac® computers.

1 On your computer, go to garmin.com/express.

2 Select an option:

- To view the system requirements and verify the Garmin Express application is compatible with your computer, select **System Requirements**.
- To install on a Windows computer, select **Download for Windows**.
- To install on a Mac computer, select **Download for Mac**.

3 Open the downloaded file, and follow the on-screen instructions to complete the installation.

Charging the Device

NOTE: This Class III product shall be powered by an LPS power supply.

You can charge the battery in the device using any of these methods.

- Install the device in the mount, and connect the mount to vehicle power.
- Connect the device to an optional power adapter accessory, such as a wall power adapter.

You can purchase an approved Garmin AC-DC adapter suitable for home or office use from a Garmin dealer or www.garmin.com. The device may charge slowly when connected to a third-party adapter.

Device Care

NOTICE

Avoid dropping your device.

Do not store the device where prolonged exposure to extreme temperatures can occur, because it can cause permanent damage.

Never use a hard or sharp object to operate the touchscreen, or damage may result.

Do not expose the device to water.

Cleaning the Outer Casing

NOTICE

Avoid chemical cleaners and solvents that can damage plastic components.

- 1 Clean the outer casing of the device (not the touchscreen) using a cloth dampened with a mild detergent solution.
- 2 Wipe the device dry.

Cleaning the USB Port

- 1 Turn off the device and disconnect the device from power.
- 2 Clean the USB port using a soft, clean, lint-free cloth or cotton swab.
NOTE: If necessary, you can lightly dampen the cloth or cotton swab with isopropyl alcohol.
- 3 Allow the device to dry completely before you connect it to power.

Cleaning the Touchscreen

- 1 Use a soft, clean, lint-free cloth.
- 2 If necessary, lightly dampen the cloth with water.
- 3 If using a dampened cloth, turn off the device and disconnect the device from power.
- 4 Gently wipe the screen with the cloth.

Resetting the Device

You can reset your device if it stops functioning.

Hold the power key for 12 seconds.

Removing the Device, Mount, and Suction Cup

Removing the Mount from the Suction Cup

- 1 Loosen the nut that secures the magnetic powered mount to the suction cup ball.
- 2 Turn the device mount to the right or left.
- 3 Apply pressure until the socket on the mount releases the ball on the suction cup.

Removing the Suction Cup from the Windshield

- 1 Flip the lever on the suction cup toward you.
- 2 Pull the tab on the suction cup toward you.

Troubleshooting

The suction cup will not stay on my windshield

- 1 Clean the suction cup and windshield with rubbing alcohol.
- 2 Dry with a clean, dry cloth.
- 3 Mount the suction cup ([Mounting and Powering the Device in Your Vehicle, page 2](#)).

The mount does not hold my device in place while I drive

For the best results, you should keep the vehicle mount clean and position the device close to the suction cup. If the device shifts position while you are driving, you should complete these actions.

- Remove the powered mount from the suction cup arm, and wipe the ball and socket with a cloth.
Dust and other debris may reduce the friction in the ball and socket joint and allow the joint to shift while you are driving.
- Rotate the hinged arm toward the suction cup as far as your windshield angle allows.
Positioning the device closer to the windshield reduces the effect of jarring and vibration from the road.

My device is not acquiring satellite signals

- Verify the GPS simulator is turned off ([Navigation Settings, page 51](#)).
- Take your device out of parking garages and away from tall buildings and trees.
- Remain stationary for several minutes.

The device does not charge in my vehicle

- Verify the vehicle is turned on and is supplying power to the power outlet.
- Verify the interior temperature of the vehicle is within the charging temperature range indicated in the specifications.
- In the vehicle fuse box, verify the fuse for the vehicle power outlet is not broken.

My battery does not stay charged for very long

- Decrease the screen brightness (*Display Settings, page 52*).
- Shorten the display timeout (*Display Settings, page 52*).
- Decrease the volume (*Adjusting the Volume, page 10*).
- Turn off the wi-fi radio when it is not in use (*Connecting to a Wireless Network, page 51*).
- Put the device in power saving mode when not in use (*Turning the Device On or Off, page 7*).
- Keep your device away from extreme temperatures.
- Do not leave your device in direct sunlight.

My device does not connect to my phone

- Select  > **Phone**, and verify that your phone is paired with the navigator.
- Enable Bluetooth wireless technology on your phone, and bring your phone within 10 m (33 ft.) of the device.
- Verify your phone is compatible.
Go to www.garmin.com/bluetooth for more information.
- Complete the pairing process again.
To repeat the pairing process, you must unpair your phone and device (*Deleting a Paired Phone, page 37*), and complete the pairing process.

Appendix

Viewing GPS Signal Status

Hold  for three seconds.

Garmin PowerSwitch

WARNING

Garmin strongly recommends having an experienced installer with the proper knowledge of electrical systems install the device. Incorrectly wiring the power cable can result in damage to the vehicle or the battery and can cause bodily injury.

You can use a connected Garmin PowerSwitch device to control lights, fans, and more from your dēzl device.

Mounting Considerations

- The device must be mounted close to the battery and within the range of the supplied power cable.
- The mounting surface must be strong enough to support the weight of the device.
- The location must allow room for the routing and connection of all cables.

Mounting the Device

Before you can mount the device, you must select a mounting location and purchase the appropriate hardware for your mounting surface.

NOTICE

Avoid wires, gauges, air bags, air bag covers, HVAC, and other items when drilling pilot holes and attaching the mount to the vehicle. Garmin is not responsible for any damages or consequences arising from the installation.

- 1 Place the mount on the selected location.



- 2 Using the mount as a template, mark the two screw locations ①.
- 3 Drill pilot holes (optional).
For some types of mounting material, drilling pilot holes is necessary. Do not drill through the mount.
- 4 Securely fasten the mount to the surface using the appropriate hardware for your mounting surface.

Opening the Front Cover

You must open the front cover to make electrical connections.

- 1 Lift the front cover latch ① and rotate it counter-clockwise.



- 2 Pull the front cover off of the device.



Connecting Accessories

NOTICE

Do not use the device to control or power a winch. Failure to follow this notice could cause damage to your vehicle or your device.

Do not connect a power source to an accessory output terminal. Failure to follow this notice could cause damage to your vehicle or your device.

Accessory requirements:

- Verify the amperage rating of each accessory before wiring it to the Garmin PowerSwitch device. The device supports accessories up to 30 A for each channel and a maximum of 100 A for the entire system.
- Use 10 AWG (6 mm²) wires for accessories that use 20 to 30 A.
- Use 12 AWG (4 mm²) wires for accessories that use 10 to 20 A.
- Use 14 AWG (2.5 mm²) wires for accessories that use less than 10 A.
- Use the appropriate size terminals for all accessory connections.
- Crimp all terminal connectors securely.

- 1 Connect the positive wire from the accessory ① to one of the accessory terminals ② on the Garmin PowerSwitch device.

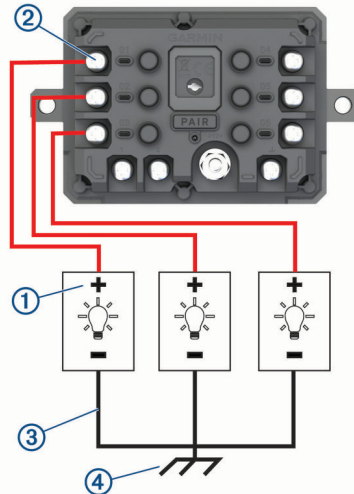

- 2 Connect the negative or ground wire ③ to an unpainted ground stud ④ on the vehicle frame, to a ground distribution block, or directly to the negative terminal on the battery.

⚠ CAUTION

Do not connect the accessory ground wires to the ground terminal (GND) on the Garmin PowerSwitch device, as doing so could result in personal injury or property damage, or could negatively impact device functionality.

- 3 Verify that all electrical connections are tight and will not come loose during use.

Connecting a Control Input

You can connect to the control terminals to enable the Garmin PowerSwitch device to turn on customizable outputs. For example, you can connect your vehicle ignition switch to a control input terminal to turn on accessories automatically each time you start your vehicle. The control terminals detect a signal from 3.3 V to 18 V. You can configure output functions with the Garmin PowerSwitch app.

Connect the control wire from the control source in your vehicle to one of the two control terminals on the Garmin PowerSwitch device.

Connecting the Device to Vehicle Power

Before you can connect the device to vehicle power, you must remove the warning tag from the +12V terminal on the device.

You should always confirm all electrical connections are secure and will not come loose while operating the device.

- 1 Connect the large ring end of the included ground wire ① to the negative terminal on the vehicle battery.

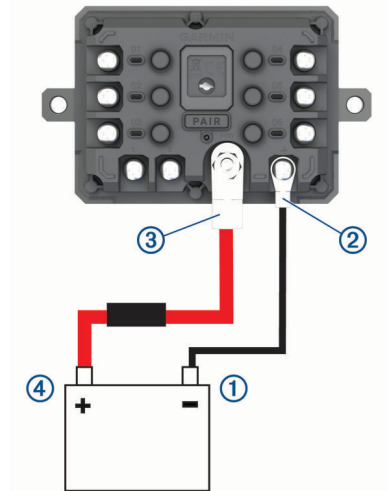

- 2 Connect the small ring end of the ground wire to the **GND** terminal ② on the device.
- 3 Connect the small ring end of the included 12V cable to the **+12V** terminal ③ on the device.
- 4 Tighten the $\frac{3}{8}$ in. nut on the +12V terminal to a maximum torque specification of 4.52 N-m (40 lbf-in.). You should confirm the nut cannot be loosened by hand.

NOTICE

Do not overtighten the +12V terminal to prevent damage to the terminal.

- 5 Connect the large ring end of the 12V cable ④ to the positive terminal on the vehicle battery.

Pairing with a Garmin Navigation Device

You can pair your Garmin PowerSwitch device with a compatible Garmin navigation device.

- 1 Turn on power to your Garmin PowerSwitch device, and place your compatible Garmin navigation device within 1 m (3.3 ft.) of it.
- 2 On your compatible navigation device, open the Garmin PowerSwitch app.
- 3 Follow the on-screen instructions to complete the pairing and setup process.

The main app dashboard appears. After the devices are paired, they connect automatically when they are turned on and within range.

Garmin PowerSwitch Specifications

Dimensions (D x W x H)	75 x 125 x 32 mm (2.95 x 4.92 x 1.26 in.)
Operating temperature range	From -25° to 85°C (from -13° to 185°F)
Wireless frequency	2.4 GHz @ +15 dBm
Power input	From 12 to 16 V using the included vehicle power cable.
Maximum accessory output	30 A
Maximum system output	100 A
Current draw with all outputs off	3 mA
Water rating	IEC 60529 IPX7 ¹

Troubleshooting

My Garmin PowerSwitch will not stay connected

- Verify the Garmin PowerSwitch device is receiving power.
- Verify that Bluetooth technology is enabled on your paired navigation device or smartphone.
- Move the navigation device or smartphone closer to your Garmin PowerSwitch device.
- Verify that your vehicle's battery is supplying at least 12 V of power.

The Garmin PowerSwitch device turns off all outputs automatically to preserve your vehicle's battery if it is receiving less than 11 V of power (*My accessories are not receiving power, page 64*).

My accessories are not receiving power

- Verify the Garmin PowerSwitch device is receiving power from the vehicle battery.
- Verify that your vehicle's battery is supplying at least 12 V of power.

The Garmin PowerSwitch device turns off all outputs automatically to preserve your vehicle's battery if it is receiving less than 11 V of power. Outputs turn back on when the device detects more than 12 V of power.

- Verify that all electrical connections are secure and will not come loose while operating the vehicle.
- Verify that each connected accessory draws less than 30 A.
If an accessory draws more than 30 A, the device turns off that output automatically.
- Verify that the total system load is less than 100 A.
If the device detects a system load of more than 100 A, it turns off all outputs automatically.
- Inspect all electrical connections for an electrical short circuit.

Wireless Cameras

Your device can display the video feed from one or more connected wireless cameras (sold separately).

¹ The device withstands incidental exposure to water of up to 1 m for up to 30 min. For more information, go to www.garmin.com/waterrating.

Pairing a BC™ 50 Camera with a Garmin Navigation Device

You can pair the BC™ 50 camera with a compatible Garmin navigation device. Go to garmin.com/backupcamera for more information about device compatibility.

- 1 Update your navigation device to the latest software.
Your device may not support the BC™ 50 camera without the latest software. For more information about updating the device software, see the owner's manual for your navigation device.
- 2 Select  > **Cameras** > **Add New Camera**.
- 3 Follow the on-screen instructions to finish pairing and setting up the camera.

After you complete the pairing process with a camera for the first time, it connects automatically to the Garmin navigation device when power is applied.

Connecting a Wired Backup Camera

To connect a wired backup camera, you must use a magnetic video mount accessory (sold separately), which includes a 3.5 mm composite video input jack. Go to garmin.com to purchase an accessory mount.

You can connect a wired backup camera and view the output on the device screen.

- 1 Replace the original device mount with the video mount accessory.
- 2 Insert the camera video cable plug into the video input jack  on the mount.

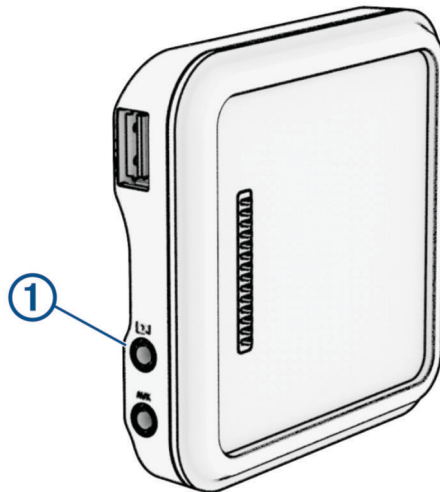

Viewing the Backup Camera

WARNING

This device is intended to enhance your situational awareness when used properly. If used improperly, you could become distracted by the display, which could lead to an accident causing serious personal injury or death. Only access the information displayed on the device with a glance. Always maintain awareness of your surroundings and do not stare at the display or become distracted by the display. Focusing on the display could prevent you from avoiding obstacles or hazards.

After you pair your camera with a compatible Garmin navigation device, the camera view appears automatically when you turn on your navigation device, and you can manually show the camera at any time.

- If your navigation device is connected to an ignition-switched power outlet (recommended), turn on your vehicle.
- If your navigation device is connected to an always-on power outlet, turn on the navigation device.
- To show the camera manually, select .
- To show or hide the camera using voice commands, say **Show Video** or **Hide Video**.

NOTE: Voice commands are not available on all navigation devices. The voice commands may vary based on your navigation device model. This feature is not available for all languages or may require additional navigation device setup for some languages. For more information, see the OK, Garmin app on your navigation device, or the navigation device owner's manual.

The camera view appears. When the camera detects the vehicle is moving forward, the camera automatically stops sending video, and the navigation device returns to normal operation. The camera video is dismissed automatically after 2 minutes and 30 seconds, whether or not your vehicle has moved forward.

Switching Cameras

When multiple backup cameras are transmitting to your device, you can switch between the views from the cameras.





From the camera view, select an option:

- Select .
- Tap the screen, and select a camera at the bottom of the screen.

The video feed from the camera appears.

Changing the Camera Orientation

Depending on where the camera is placed on your vehicle, the video on your device may appear upside down or mirrored by default. You can rotate the video horizontally or flip the video vertically to correct the video.

- 1 From the camera view, select an option:
 - Select  > **Adjust Video**.
 - Tap the screen, and select .
- 2 Select  to reverse the image or  to flip the image.
- 3 Select .

Connecting a Dash Camera to the Powered Mount

WARNING

It is your responsibility to ensure the mounting location complies with all applicable laws and ordinances, and does not block your view of the road to ensure safe operation of your vehicle.

Before you connect a dash camera to the powered mount, you should mount the dash camera device to your windshield.

You can use the dēzl device mount to power a compatible Garmin dash camera. This can be useful if you need to connect the dēzl device and the dash camera to the same power source in your vehicle.

- 1 Mount the dēzl device in your vehicle, and connect it to power (*Mounting and Powering the Device in Your Vehicle, page 2*).
- 2 If necessary, remove the dēzl device from the magnetic mount for a better view of the USB port.
- 3 Plug the dash camera's power cable into the USB port  on the mount.

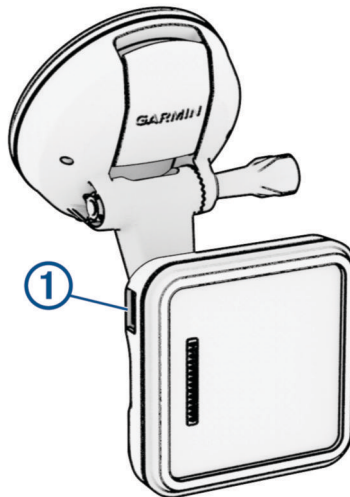

Data Management

The device has a memory card slot for additional data storage.

NOTE: The device is compatible with Windows 7 and newer, and Mac OS 10.7 and newer.

About Memory Cards

You can purchase memory cards from an electronics supplier, or purchase pre-loaded Garmin mapping software (www.garmin.com). Memory cards can be used to store files such as maps and custom POIs.

Installing a Memory Card for Maps and Data

You can install a memory card to increase the storage space for maps and other data on your device. You can purchase memory cards from an electronics supplier. The device supports microSD memory cards from 4 to 256 GB. Memory cards must use the FAT32 file system format. Memory cards greater than 32 GB must be formatted using the device.

- 1 Locate the map and data memory card slot on your device (*Device Overview, page 1*).
- 2 Insert a memory card into the slot.
- 3 Press it in until it clicks.

Connecting the Device to Your Computer

You can connect the device to your computer using a USB cable.

- 1 Plug the small end of the USB cable into the port on the device.
- 2 Plug the larger end of the USB cable into a port on your computer.
- 3 From your dēzl device, select **Tap to Connect to Computer**.

A picture of your device connected to a computer appears on the device screen.

Depending on your computer operating system, the device appears as either a portable device, a removable drive, or a removable volume.

Transferring Data From Your Computer

- 1 Connect the device to your computer (*Connecting the Device to Your Computer, page 68*).

Depending on your computer operating system, the device appears as either a portable device, a removable drive, or a removable volume.

- 2 On your computer, open the file browser.
- 3 Select a file.
- 4 Select **Edit > Copy**.
- 5 Browse to a folder on the device.

NOTE: For a removable drive or volume, you should not place files in the Garmin folder.

- 6 Select **Edit > Paste**.

Purchasing Additional Maps

- 1 Go to your device product page at garmin.com.
- 2 Click the **Maps** tab.
- 3 If necessary, select a continent and a map type.
- 4 Select a map.
- 5 Follow the on-screen instructions.

Purchasing Accessories

- Optional accessories are available at garmin.com or from your Garmin dealer.

