

MONITOR WITH RECEIVER INSTRUCTION MANUAL

ENGLISH

JVCKENWOOD Corporation

DMX809S DMX8709S

This instruction manual is used to describe the models listed above. Model availability and features (functions) may differ depending on the country and sales area.

Take the time to read through this instruction manual.

Familiarity with installation and operation procedures will help you obtain the best performance from your new receiver.

For your records

Record the serial number, found on the back of the unit, in the spaces designated on the warranty card, and in the space provided below. Refer to the model and serial numbers whenever you call upon your Kenwood dealer for information or service on the product.

Model DMX809S/DMX8709S Serial number _____

US Residents Only

Register Online

Register your Kenwood product at <https://www.kenwood.com/usa/>

Important Notice

To ensure proper use, please read through this manual before using this product. It is especially important that you read and observe WARNINGS and CAUTIONS in this manual.

Please keep the manual in a safe and accessible place for future reference.

WARNINGS

To prevent accidents and damages

- DO NOT install any unit or wire any cable in a location where;
 - it may obstruct the steering wheel and gearshift lever operations.
 - it may obstruct the operation of safety devices such as air bags.
 - it may obstruct visibility.
- DO NOT raise the volume level too much, as this will make driving dangerous by blocking outside sounds, and may cause hearing loss.
- DO NOT operate the unit while driving. If you need to operate the unit while driving, be sure to look around carefully.
- Stop the car before performing any complicated operations.
- The driver must not watch the monitor while driving.

CAUTIONS

To care for the unit

- If you have parked the car for a long time in hot or cold weather, wait until the temperature in the car becomes normal before operating the unit.

To care for the monitor

- The monitor built into this unit has been produced with high precision, but it may have some ineffective dots. This is inevitable and is not considered defective.
- Do not expose the monitor to direct sunlight.
- Do not operate the touch panel using a ball-point pen or similar tool with a sharp tip.
Touch the keys on the touch panel with your finger directly (if you are wearing a glove, take it off).
- When the temperature is very cold or very hot...
 - Chemical changes occur inside, causing malfunction.
 - Pictures may not appear clearly or may move slowly. Pictures may not be synchronized with the sound or picture quality may decline in such environments.

On the volume setting

- Digital devices produce very little noise compared with other sources. Lower the volume before playing these digital sources to avoid damaging the speakers by sudden increase of the output level.

FCC CAUTION

Changes or modifications not expressly approved by the party responsible for compliance could void the user's authority to operate the equipment.

NOTE: This equipment has been tested and found to comply with the limits for a Class B digital device, pursuant to part 15 of the FCC Rules. These limits are designed to provide reasonable protection against harmful interference in a residential installation. This equipment generates, uses and can radiate radio frequency energy and, if not installed and used in accordance with the instructions, may cause harmful interference to radio communications. However, there is no guarantee that interference will not occur in a particular installation. If this equipment does cause harmful interference to radio or television reception, which can be determined by turning the equipment off and on, the user is encouraged to try to correct the interference by one or more of the following measures:

- Reorient or relocate the receiving antenna.
- Increase the separation between the equipment and receiver.
- Connect the equipment into an outlet on a circuit different from that to which the receiver is connected.
- Consult the dealer or an experienced radio/TV technician for help.

Important Notice

Supplier's Declaration of Conformity

Trade Name: KENWOOD
Products: MONITOR WITH RECEIVER
Model Name: **DMX809S/DMX8709S**
Responsible Party: JVKENWOOD USA CORPORATION
4001 Worsham Avenue, Long Beach,
CA 90808, U.S.A.
PHONE: 1-800-252-5722

THIS DEVICE COMPLIES WITH PART 15 OF THE FCC RULES. OPERATION IS SUBJECT TO THE FOLLOWING TWO CONDITIONS:

- (1) THIS DEVICE MAY NOT CAUSE HARMFUL INTERFERENCE, AND
- (2) THIS DEVICE MUST ACCEPT ANY INTERFERENCE RECEIVED, INCLUDING INTERFERENCE THAT MAY CAUSE UNDESIRE OPERATION.

This transmitter must not be co-located or operated in conjunction with any other antenna or transmitter.

ISED Caution

This device contains licence-exempt transmitter(s)/ receiver(s) that comply with Innovation, Science and Economic Development Canada's licence-exempt RSS(s). Operation is subject to the following two conditions:

1. This device may not cause interference.
2. This device must accept any interference, including interference that may cause undesired operation of the device.

CAUTION

This equipment complies with FCC/ISED radiation exposure limits set forth for an uncontrolled environment and meets the FCC radio frequency (RF) Exposure Guidelines and RSS-102 of the ISED radio frequency (RF) Exposure rules. This equipment should be installed and operated keeping the radiator at least 20 cm or more away from person's body.

About GPS

When you turn on this unit for the first time, you must wait while the system acquires GPS signals from satellites. This process could take up to several minutes. Make sure your vehicle is outdoors in an open area away from tall buildings and trees for fastest acquisition. Once the system acquires GPS signals, this unit will acquire them quickly each time you turn on this unit.

About this manual

The displays and panels shown in this manual are examples used to provide clear explanations of the operations. For this reason, they may be different from the actual displays or panels.

This manual mainly explains operations using the buttons on the monitor panel and keys on the touch panel. For operations using the remote controller, see page 53.

< > indicates the various screens/menus/ operations/settings that appear on the touch panel.

[] indicates the keys and source names on the touch panel.

Indication language: English indications are used for the purpose of explanation. You can select the indication language from the <Setup> menu (page 50).



This symbol on the product means there are important operating and maintenance instructions in this manual. Be sure to carefully read instructions in this manual.

Contents

Component Names and Basic Operations..... 3	HD Radio™ (for DMX809S)21	Settings42
Monitor panel.....3	About HD Radio™ Technology21	Audio settings42
Home screen3	Listening to the radio.....22	Display settings.....46
Turning on the power3	Changing the receive mode23	Input settings.....48
Turning off the power3	Presetting stations in the memory23	System settings.....50
Putting the unit in standby4	Selecting a preset station24	Remote Controller.....52
Turning off the screen4	Using Emergency Alert24	Preparation52
Adjusting the volume.....4	Radio (for DMX8709S)25	Basic operations for KCA-RCDV340.....53
Attenuating the sound4	Listening to the radio.....25	Installation and Connection54
Initial settings.....4	Presetting stations in the memory26	Before installation54
Date and clock settings.....5	Selecting a preset station27	Installing the unit.....56
In-Car Connections.....6	SiriusXM® Satellite Radio 27	Removing the unit56
USB connection.....6	Listening to the SiriusXM® Satellite Radio28	Installing the supplied GPS antenna57
Bluetooth® connection.....7	Selecting a channel.....29	Connecting external components58
Connections setting11	Presetting channels in the memory29	Wiring connection59
Various Screens and Operations 12	Selecting a preset channel.....30	References60
Source/option selection screen12	Replaying content30	Maintenance60
Source control screen.....13	SiriusXM Satellite Radio features.....30	More information60
List/setting screen.....14	Content Alert.....31	Troubleshooting.....62
Apps14	Setting reception restrictions33	Specifications66
Using Apps of iPhone — Apple CarPlay.....14	Resetting the SiriusXM Satellite Radio settings34	Trademarks and Licenses.....68
Using the Apps of an Android™ device	Other External Components35	Important Notice on Software69
— Android Auto™16	HDMI/AV-IN devices.....35	EULA70
Using the Apps of an Android device	Cameras.....35	
— USB Mirroring.....17	Using an external component via ADS adapter	
USB18	— OEM Features.....36	
Playback operations.....18	Bluetooth® Device37	
Video playback operations19	Bluetooth mobile phone37	
Search operations20	Bluetooth mobile phone settings.....39	
Settings for USB playback21	Bluetooth audio player40	

Component Names and Basic Operations

Monitor panel

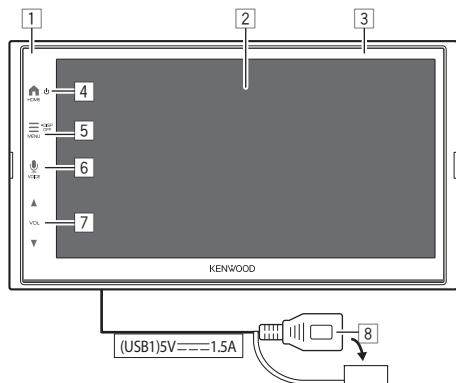

- 1 Remote sensor
- 2 Screen (touch panel)
- 3 Monitor panel
- 4 **HOME** button
 - (Press): Turns on the power.
 - (Hold): Turns off the power.
 - **HOME** (Press): Displays the Home screen (see the following) while the power is on.
- 5 **MENU/DISP OFF** button
 - **MENU** (Press): Pops up the function menu (page 13).
 - **DISP OFF** (Hold): Turns off the screen.

- 6 **VOICE** button: (Press) Activates the voice recognition.
 - When no device for Apple CarPlay, Android Auto, and Bluetooth phone is connected, pressing and holding this button displays Bluetooth pairing waiting dialog (page 7).
- 7 **VOL** ▲/▼ buttons
- 8 USB terminal from the rear panel

The buttons on the monitor illuminate and change the color periodically with the unit turned on.

- To change the color, see page 47.

Home screen

- You can customize the Home screen (page 48).
- To display the Home screen from other screens, press the **HOME** button.



Eg. Home screen for **DMX809S**

Touching the operation keys performs the following actions:

- 1 Displays the control screen of current source.
- 2 Displays the source/option selection screen.
- 3 Short-cut playback source icons
- 4 Displays the Hands Free screen when a Bluetooth phone is connected.
 - When connected as Apple CarPlay or Android Auto, it works as a phone provided in Apple CarPlay or Android Auto.

Turning on the power



- When you turn on this unit for the first time, you must wait while the system acquires GPS signals from satellites. This process could take up to several minutes.

Turning off the power



Component Names and Basic Operations

Putting the unit in standby

1 Display the source/option selection screen.

From the Home screen (page 3), touch as follows:



2 Put the unit in standby.

On the source/option selection screen (page 12):



Turning off the screen

■ On the monitor panel

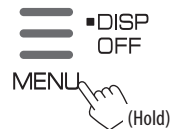

To turn on the screen: Press the **DISP OFF** button on the monitor panel or touch the screen.

■ On the pop-up menu



To turn on the screen: Touch the screen.

Adjusting the volume

▲ You can adjust the volume (00 to 40) by pressing VOL ▲ to increase and pressing VOL ▼ to decrease.



- When volume level is below 15, holding VOL ▲ increases the volume continuously to level 15.

Attenuating the sound

On the source control screen:



To cancel attenuation:



Initial settings

When you power on the unit for the first time or initialized, the **<Initial Setup>** screen appears.

Perform the initial settings.

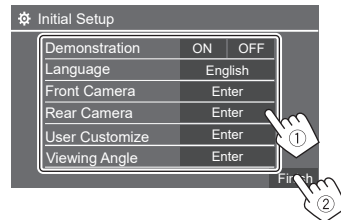

Once completed, Home screen appears.

<Demonstration> (page 48)

- **ON** (Initial): Activates the display demonstration.
- **OFF**: Deactivates the display demonstration.

<Language> (page 50)

Select the text language used for on-screen information.

- **English** (Initial)/**Español**/**Français**
- **GUI Language (Local)** (the language selected above) (Initial)/**English**: Selects the language used for displaying operation keys and menu items.

<Front Camera> (page 48)

Make the settings to display the picture from the connected front view camera.

Component Names and Basic Operations

<Rear Camera> (page 49)

Make the settings to display the picture from the connected rear view camera.

<User Customize> (page 47)

Change the display design.

<Viewing Angle> (page 48)

Select the viewing angle in relation to the monitor to make the image on the screen easier to see.

- **Under 0° (Initial)/5°/10°/15°/20°**

Date and clock settings

1 Display the Home screen.



2 Display the <Setup> screen.

From the Home screen (page 3), touch as follows:



- ### 3 Display the <System> screen (①), and then enter the item-setting screen you want to change (②).

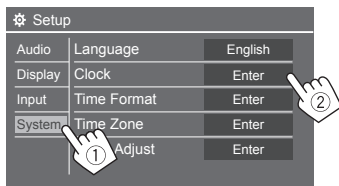

Eg. When selecting <Clock>

4 Set or adjust the date and clock items.

<Clock>*

Select the method to set the date and clock.

- **GPS-SYNC (Initial):** Synchronizes the clock time with GPS.
- **Manual:** Sets the clock manually using <Clock Adjust>. See the following.

<Time Format>

Select the time display format.

- **[12-Hour] (Initial)/[24-Hour]**

<Time Zone>

Select the time zone for your residential area.

- **Pacific Time (Initial)/Central Time/Mountain Time/Eastern Time, etc.**

<Clock Adjust>

Touch [▲]/[▼] (①) to adjust the date (year/month/date), and adjust the hour/minute. Touch [SET] (②) to finish setting the clock.

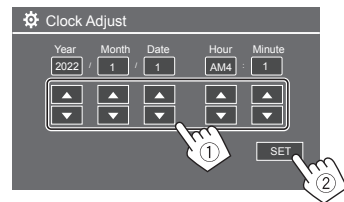

<Daylight Saving Time>

(Not used when the clock is set manually)

Activate this by selecting the additional time for Daylight Saving Time (if available in your residential area).

- **OFF (Initial)/30min/1Hr**

* You can also display the <Clock> screen by touching the clock area if shown on the Home screen.

In-Car Connections

To operate your smartphone hands-free, and Apps of the smartphone (Apple CarPlay, Android Auto, and USB Mirroring), the following connections are required.

- **For Wired Apple CarPlay** (page 14), connect iPhone with USB.
- **For Wireless Apple CarPlay** (page 14), connect iPhone with Bluetooth (Wi-Fi is auto-connected).
- **For Android Auto** (page 16):
 - Android device with Android version 6.0 or later can be used with USB (In this case, Bluetooth is auto-connected, but Wi-Fi is not available)
 - To wirelessly use Android Auto with this unit, connect Android device with Bluetooth (Wi-Fi is auto-connected)
 - You need a compatible Android device (see below) with an active data plan.
 - An Android device with Android version 11 or later and 5 GHz Wi-Fi (subject to local regulations*); or
 - A Google-branded or Samsung-branded device with Android version 10; or
 - A Samsung Galaxy S8, Galaxy S8+ or Note 8, with Android 9
 - You can find more information at g.co/androidauto/requirements.

* Refer to the local regulations of your residential area.

- **For USB Mirroring** (page 17) connect the Android device both with USB and Bluetooth.
- **For Hands-Free Phone** (page 37), **and Bluetooth audio player** (page 40), connect your device with Bluetooth®.

- For SiriusXM Connect Vehicle Tuner connection and its usage, see pages 27 and 58.
- For HDMI device connection and its usage, see pages 35 and 58.
- For AV-IN device connection and its usage, see pages 35 and 58.
- For ADS adapter connection and its usage, see pages 36 and 58.

USB connection

Connect your smartphone (iPhone or Android device) for using Apps on the screen of this unit.

- You can also connect a USB mass storage class device such as a USB memory, digital audio player, etc. to the unit. But you cannot connect a PC, portable HDD and USB hub.

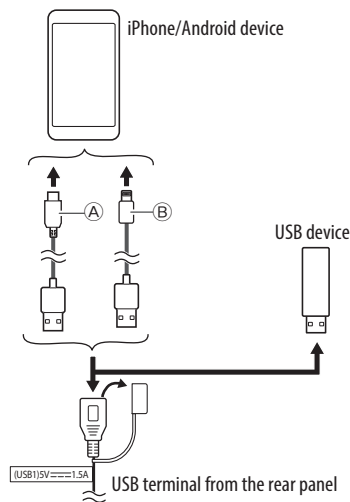

- Ⓐ For connecting your Android device, use the USB cable (commercially available)
- Ⓑ For connecting your iPhone, use the USB cable for iPhone KCA-iP103 (optional accessory)

In-Car Connections

Bluetooth® connection

Information for using Bluetooth devices

Bluetooth is a short-range wireless radio communication technology for mobile devices such as mobile phones (smartphones), portable PCs, and other devices. Bluetooth devices can be connected without cables and communicate with each other.

- Some Bluetooth devices may not be used with this unit depending on the Bluetooth version of the device.

Pairing a Bluetooth device

When you connect a Bluetooth device to the unit for the first time, register the device to this unit (pairing). Pairing allows Bluetooth devices to communicate with each other.

- The pairing method differs depending on the Bluetooth version of the device.
 - For devices with Bluetooth 2.1:
You can pair the device and the unit using SSP (Secure Simple Pairing) which only requires confirmation.
 - For devices with Bluetooth 2.0:
You need to enter a PIN code both on the device and the unit for pairing.

- Once the connection is established, it is registered in the unit until you initialize the Bluetooth settings (page 50) or the unit itself (page 51). Up to five devices can be registered in total.
- To use the Bluetooth function, you need to turn on the Bluetooth function of the device.

Auto pairing

When **<Auto Pairing>** is set to **[ON]** (page 40), Bluetooth devices are automatically paired.

- For iPhone with Apple CarPlay and Android device with Android Auto: When the device is connected via USB, it is automatically paired regardless of this setting.

Automatic Wi-Fi connections

This unit is equipped with the Wi-Fi function.

- You can turn on or off the Wi-Fi function on the **<Wireless/HDMI SETUP>** settings. To use the Wi-Fi function, select **[Wi-Fi]** (page 51).

Once your iPhone or Android device is paired successfully with Bluetooth or connected with USB for Apple CarPlay or for Android Auto, it is automatically connected with Wi-Fi. And from the next time on, it is automatically connected through Wi-Fi.

- Turn on the Bluetooth and Wi-Fi functions on your iPhone or Android device.
- It is necessary to connect the GPS antenna in order to use wireless Apple CarPlay.

Pairing a Bluetooth device using SSP (for Bluetooth 2.1)

1 Display the Home screen.



2 Display the <Device List> screen.

From the Home screen (page 3), touch as follows:

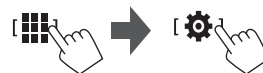

Then, on the **<Setup>** screen, touch as follows:
[System] → **<Connections SETUP>** : **[Enter]**

On the **<Connections SETUP>** screen, touch as follows:

<Device List> : **[Enter]**

- You can also use the pop-up function menu to display the **<Device List>** screen (page 13).

3 Make the unit ready for pairing.

On the **<Device List>** screen:

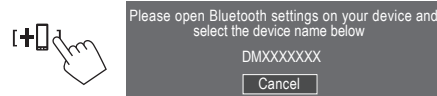

In-Car Connections

4 Search for the unit (“DMX809S” or “DMX8709S”) from your Bluetooth device.

5 Confirm the request both on the device and the unit.

On the device: Confirmation method varies for the device.

On the unit:



Pairing is complete.

To reject the request: Touch **[Cancel]**.

6 Register the usage of the Bluetooth device.

- See “Registering the usage of the devices” on page 9.

Once pairing is completed...

• **For iPhone compatible with wireless Apple CarPlay**

A confirmation message appears.

– Touch **[Yes]** to display the Apple CarPlay screen for wireless connection.

– Touch **[No]** not to use Apple CarPlay for the time being. To use Apple CarPlay, select it on the **<Device List>** screen.

• **For Android device compatible with Android Auto**

When **[Android Auto]** (initial) is selected for the **<Android Mode Select>** setting (page 11), Android Auto is automatically activated, and this Android device is registered as Android Auto device.

– If Apple CarPlay is active currently, a warning message may appear, asking whether Android Auto or Apple CarPlay is to be used (depending on iPhone version).

Pairing a Bluetooth device using a PIN code (for Bluetooth 2.0)

1 Display the Home screen.



2 Display the <PIN Code Set> screen.

From the Home screen (page 3), touch as follows:



Then, on the **<Setup>** screen, touch as follows: **[System]** → **<Connections SETUP>** : **[Enter]**

On the **<Connections SETUP>** screen, touch as follows:

<PIN Code> : **[Enter]**

3 Enter the PIN code.

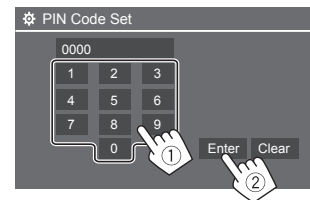

- Initial PIN Code: [0000]
- If you do not need to change the PIN code [0000], just touch **[Enter]**.
- To change the PIN code, see page 11.

In-Car Connections

4 Make the unit ready for pairing.

On the <Device List> screen:

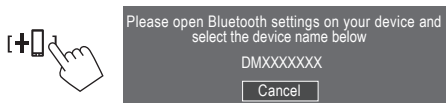

5 Search for the unit ("DMX809S" or "DMX8709S") from your Bluetooth device.

6 Select the unit ("DMX809S" or "DMX8709S") on your Bluetooth device.

Pairing is complete.

7 Register the usage of the Bluetooth device.

- See "Registering the usage of the devices" that follows.

Once pairing is completed, see page 8.

- **For iPhone compatible with wireless Apple CarPlay**
- **For Android device compatible with Android Auto**

■ Registering the usage of the devices

You can confirm and change the usage (profile) of the registered devices on the <Device List> screen.

- You can also connect/disconnect and delete unwanted devices on the device list.

1 Display the <Device List> screen.

From the Home screen (page 3), touch as follows:



Then, on the <Setup> screen, touch as follows: [System] → <Connections SETUP> : [Enter]

On the <Connections SETUP> screen, touch as follows:

<Device List> : [Enter]

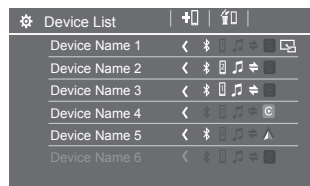

The currently activated (connected) devices are highlighted on the list.

- Six devices can be displayed on the list; five devices connected by Bluetooth and one by USB.
- You can also use the pop-up function menu to display the <Device List> screen (page 13).

- Touch [< >] scrolls the text if not all of the text is shown.
- For list/setting screen operations, see also page 14.

2 Select the device you want to use.

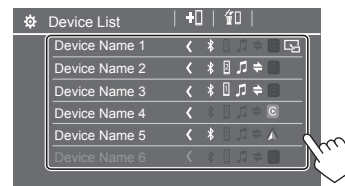

- When Apple CarPlay or Android Auto is activated for the selected device, it will be disconnected. A warning message appears. Touch [Yes] to continue.

3 Select the profile for the selected device.

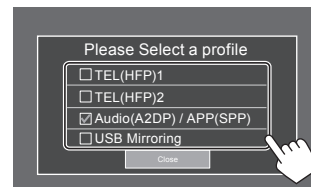

- **[TEL(HFP)1]/[TEL(HFP)2]:** To use the device as hands-free phone 1 and 2.
- **[Audio(A2DP)/APP(SPP)]:** To use the device as Bluetooth audio or Apps (Apple CarPlay/Android Auto).
- **[USB Mirroring]:** To use the device as USB Mirroring.

4 Touch [Close] to finish.

The <Device List> screen is displayed again. This unit searches for the device you have just set the usage (profile) for, and activates the device if it is connected.

About the profile icons

- Available profile for the listed devices are in white. When the profile is active for the devices, it becomes blue. Unavailable device and profile are in gray.
- Bluetooth icon is displayed only when the device is connected by Bluetooth.
- Apple CarPlay and Android Auto icons illuminate when they are active.
- Mirroring icon is displayed when the device is selected as Mirroring in profile setting.

Icon	Profile	Status (on/off/unavailable)
	Bluetooth	Bluetooth connection
	HFP1	Hands-Free phone 1
	HFP2	Hands-Free phone 2
	A2DP	Bluetooth audio player
	SPP	Apps
	Apple CarPlay	
	Android Auto	
	Mirroring	USB Mirroring

■ Adding the registered devices

1 Display the <Device List> screen.

From the Home screen (page 3), touch as follows:



Then, on the <Setup> screen, touch as follows:
[System] → <Connections SETUP> : [Enter]

On the <Connections SETUP> screen, touch as follows:

<Device List> : [Enter]

2 Activate registration.

On the <Device List> screen:



3 Follow the procedure previously explained.

- Pairing a Bluetooth device using SSP (for Bluetooth 2.1), see page 7.
- Pairing a Bluetooth device using a PIN code (for Bluetooth 2.0), see page 8.

■ Deleting the registered devices

1 Display the <Device List> screen.

From the Home screen (page 3), touch as follows:



Then, on the <Setup> screen, touch as follows:
[System] → <Connections SETUP> : [Enter]

On the <Connections SETUP> screen, touch as follows:

<Device List> : [Enter]

2 Display the <Device Remove> screen.

On the <Device List> screen:



3 Select the device you want to delete.

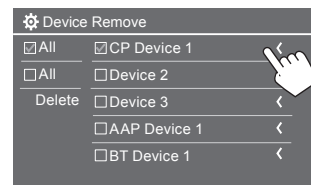

- To select all devices, touch [All].
- To deselect all devices, touch [All].

4 Touch [Delete].

A warning message appears. Touch [Yes] to delete.

In-Car Connections

Connections setting

You can change various settings for the connected devices.

1 Display the <Connections SETUP> screen.

From the Home screen (page 3), touch as follows:



Then, on the <Setup> screen, touch as follows: [System] → <Connections SETUP> : [Enter]

On the <Connections SETUP> screen, you can change and confirm the following item settings.

- For list/setting screen operations, see also page 14.

⚙ Connections SETUP	
Device List	Enter
PIN Code	0000
Device Name	(Model name)
Bluetooth Device Address	00:00:00:00:00:00
Initialize	Enter ⌵
TEL SETUP	Enter

⚙ Connections SETUP	
Wi-Fi Setup	Enter
Device Audio Control	Enter
Driving Position	Left Right
Android Mode Select	Enter
Reset Android Auto Wireless Connection	Enter

<Device List>

Devices connected for Apple CarPlay, Android Auto, USB Mirroring, Bluetooth phone, and Bluetooth audio are listed. You can check their names and their status on the list (page 10).

<PIN Code>

- To change the PIN code, enter a new PIN code and touch [Enter] to finish.
- To correct the PIN code input, touch and hold [Clear], and re-enter the PIN code.
- This setting is available only when iPhone with Apple CarPlay is not connected.

<Device Name>

Shows the device name of this unit to be shown on the Bluetooth device — **DMX809S** or **DMX8709S**.

<Bluetooth Device Address>

Shows the Bluetooth device address of this unit.

<Initialize>

Initialize the Bluetooth settings (page 50).

<TEL SETUP>

See step 2 on page 40.

- This setting is available only when iPhone with Apple CarPlay is not connected.

<Wi-Fi Setup>

Shows the device name, device address and password of this unit.

<Device Audio Control>

Go to step 2 on page 12.

<Driving Position>

Set your driver's seat position of your car — [LEFT] (initial) or [RIGHT].

This setting changes the sidebar/button position of Apple CarPlay/Android Auto screens accordingly with the driver seat position.

- This setting is available only when iPhone with Apple CarPlay and Android device with Android Auto are not connected.

<Android Mode Select>

Select Android device usage for Apps — either [Android Auto] (initial) (page 16) or [Mirroring for Android] (page 17).

- This setting is available only in Standby Mode with no device connected via USB.

<Reset Android Auto Wireless Connection>

Reset Android Auto wireless connection when you want to change the password for wireless connection manually. The system of this unit is rebooted after touching [Yes].

2 Touch [Enter] to display the selected item screen.

On the <Device Audio Control> screen:

Device Audio Control	
Guidance/Voice Recognition Volume	Enter
Phone Incoming Volume	Enter
Phone Calling/Talking Volume	Enter
Speech Quality Adjust	Enter
Media Volume	◀ 15 ▶

- <Guidance/Voice Recognition Volume> can be set separately for <Apple CarPlay> and <Android Auto> within the range of 00 to 40 (Initial: 19).
- <Phone Incoming Volume>, <Phone Calling/Talking Volume> can be set separately for <Apple CarPlay> and <Android Auto/Bluetooth> within the range of 00 to 40 (Initial: 15).
- <Speech Quality Adjust>:
<Microphone Level> can be set within the range of -10 to +10 (Initial: -4).
<Echo Cancel Level>, <Noise Reduction Level> can be set within the range of -5 to +5 (Initial: 0).
- <Media Volume> can be set within the range of 00 to 40 (Initial: 15).

Various Screens and Operations

You can display or change to other screens at any time to show information, change the playback source, change the settings, etc.

Source/option selection screen

Touch  on the Home screen to display the source/option selection screen.

- Only the available icons at that time are shown on the screen.

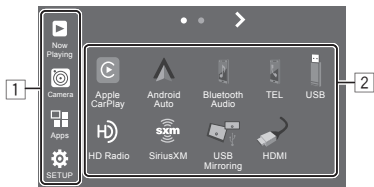

Eg. Source/option selection screen for DMX809S

Touching the operation keys performs the following actions:

1 Left-side keys

[Now Playing]	Displays the control screen of current source.
[Camera]	Switches to the camera view (page 35).
[Apps]	Switches to the currently available Apps—[Apple CarPlay] or [Android Auto].
[SETUP]	Displays the <Setup> screen (page 42).

2 Source/option keys

[Apple CarPlay]	Displays the home screen of Apple CarPlay.
[Android Auto]	Displays the home screen of Android Auto.
[Bluetooth Audio]	Plays a connected Bluetooth audio player.
[TEL]	Displays the phone control screen.
[USB]	Plays files on a USB device.
[HD Radio]	(For DMX809S) Switches to the HD Radio broadcast.
[Radio]	(For DMX8709S) Switches to the radio broadcast.
[SiriusXM]	Switches to the SiriusXM® radio broadcast.
[USB Mirroring]	Displays the screen of USB Mirroring.
[HDMI]	Switches to the HDMI device.
[AV-IN]	Switches to the external AV component connected to the AV-IN input terminal.
[STANDBY]	Puts the unit in standby.
[OEM Features]	Switches to the source connected via ADS adapter.

Various Screens and Operations

To change the page: Touch [>] / [<]. Current page is shown by the page indication on the top of the screen.

To return to the Home screen: Press the **HOME** button on the monitor panel.

Source control screen

You can operate the playback source using the source control screen.

- The operation keys and information displayed vary for each source. Here the common operation keys are explained. For more about the other operation keys, see the respective page of each source section.

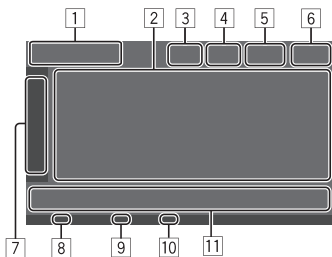

- 1 Current playback source icon and name
 - Touch [>] to show the source icons on the Home screen. Then touch [<] to hide the other icons.
- 2 Content information area

- Touch [<] to scroll the text if not all of the text is shown.
 - Touch [<] to widen the window to show more detailed information. Then touch [>] to close the window.
- 3 Phone control screen indicator
 - Touch to display the phone control screen (page 38).
 - 4 Sound attenuating key (page 4)
 - 5 TEL indicator is shown when a hands-free phone is connected.
 - 6 Clock display
 - 7 Operation window tab
 - Touch [>] to widen the operation window to show more operation keys besides those shown on the operation key area (11). Then touch [<] to close the window.
 - 8 For DMX809S: EA indicator (page 24)
 - 9 For DMX8709S: TI indicator (page 26)
 - 10 SiriusXM signal strength indicator (page 28)
 - 11 Operation key area

Using the pop-up function menu





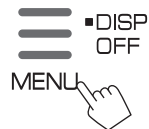

You can easily access the frequently used features.

1 Display the pop-up function menu.



2 Touch one of the following items you want to use.



- | | |
|--|---|
| [ Device List] | Displays the <Device List> screen (page 9). |
| [ Screen Adjustment] | Displays the <Screen Adjustment> screen (page 48). |
| [ Display OFF] | Turns off the screen. <ul style="list-style-type: none">• To turn on the display, touch anywhere on the screen. |
| [ Camera] | Displays the view from the connected camera (page 35). |
| [ SETUP] | Displays the <Setup> screen (page 42). |
| [ Standby] | Icon varies depending on current playing source. |

Various Screens and Operations

To close the pop-up function menu: Touch the screen anywhere other than the pop-up function menu.

List/setting screen

Below are the common operation keys which appear on the list/setting screen.

- The appearance or location of the operation keys may differ, however the similar operation keys have the same operations.
- Available operation keys differ depending on the setting screens. Not all these operation keys are shown on every screen.

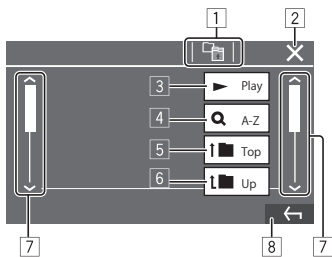

Touching the operation keys performs the following actions:

- 1 Return to the upper layer.*1
- 2 Finishes the setting and closes the current screen.
- 3 Plays all files in the folder containing the current file.

4 (Not displayed for folder list) Enters alphabet search to list the items in alphabetical order.*2
When a key pad is displayed, follow the procedure below.

- 1 Touch the first letter you want to search for.
 - To search by a number, touch [1,2,3...].
 - To search by a symbol, touch [#].
- 2 Select your desired item on the search result list.

- 5 Returns to the root folder.*2
- 6 Returns to the upper layer.*2
- 7 Changes the page to display more items.
- 8 Returns to the previous screen.

*1 Only for Bluetooth Audio

*2 Only for USB

Apps

You can use the Apps installed in your iPhone and Android device by using "Apple CarPlay," "Android Auto," and "USB Mirroring."

- **For iPhone:** You can use **Apple CarPlay** (see the following).
- **For Android device:** You can use **Android Auto** (page 16) and **USB Mirroring** (page 17).

Preparation:

Make sure that the microphone is connected (page 59).

Using Apps of iPhone — Apple CarPlay

About Apple CarPlay

Apple CarPlay is a smarter, safer way to use your iPhone in the car. Apple CarPlay takes the things you want to do with iPhone while driving and displays them on the screen of this unit. You can get directions, make calls, send and receive messages, and listen to the music from iPhone while driving. You can also use Siri voice control to make it easier to operate iPhone.

- For details about Apple CarPlay, visit <<https://apple.com/ios/carplay/>>.

Apps

Compatible iPhone devices

You can use Apple CarPlay with the following iPhone models.
iPhone 6S, 6S Plus, 7, 7 Plus, 8, 8 Plus, X, XS, XS Max, XR, 11, 11 Pro, 11 Pro Max, SE (1st/2nd generation), 12, 12 mini, 12 Pro, 12 Pro Max, 13, 13 mini, 13 Pro, 13 Pro Max

Connecting iPhone compatible with Apple CarPlay

See pages 6 to 10.

If two iPhone devices compatible with Apple CarPlay are connected wirelessly, the device recognized first is used for Apple CarPlay. To use the other iPhone, select it on the <Device List>.

Starting Apple CarPlay

Once the wireless setting and connection are done for the first time, the source is automatically changed, and you can use of the Apps of the connected iPhone.

- Unlock your iPhone beforehand.
- You cannot use Apple CarPlay when the screen recording function is enabled on the iPhone.

To change the source from the others

Touch **[Apple CarPlay]** on the source/option selection screen (page 12).

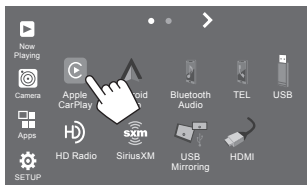

Eg. Source/option selection screen for DMX809S

The Apple CarPlay screen is displayed.

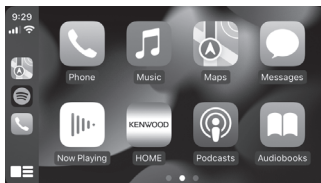

Apple CarPlay screen operation

You can use the Apps of the connected iPhone. The items displayed and the language used on the screen differ among the connected devices.

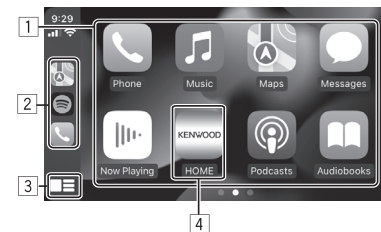

- 1 Application buttons
Starts the application.
- 2 Short cut buttons
- 3 [Menu] button
 - (Touch) Displays the home screen of Apple CarPlay.
 - (Hold) Activates Siri.
- 4 [HOME] button*
Exits the Apple CarPlay screen and displays the Home screen.

* This icon design may change depending on the iOS version.

To exit the Apple CarPlay screen

Touch **[HOME]** on the Apple CarPlay screen, or press **HOME** button on the monitor panel.

Apps

Using Siri

You can activate Siri while the Apple CarPlay screen is displayed.

On the monitor panel:

- 1 Press the  button on the monitor panel.
- 2 Talk to Siri through the microphone.

To deactivate Siri, press the button again.

On the Apple CarPlay screen:

- 1 Touch and hold .
- 2 Talk to Siri through the microphone.

To deactivate Siri, touch .

Using the Apps of an Android™ device — Android Auto™

About Android Auto

Android Auto enables you to use features of your Android device convenient for driving. You can easily access route guidance, make calls, listen to music, and access convenient features on the Android device while driving.

- For details about Android Auto, visit <<https://www.android.com/auto/>> and <<https://support.google.com/androidauto>>.

Compatible Android devices

- See page 6.

Connecting an Android device compatible with Android Auto

See pages 6 to 10.

- If two Android devices compatible with Android Auto are connected wirelessly, the device recognized first is used for Android Auto. To use the other Android device, select it on the <Device List>.
- Bluetooth mobile phone currently connected is disconnected when Android device with Android Auto is connected with Bluetooth.

Starting Android Auto

Selecting [Android Auto] on the screen displays the Android Auto screen and enable use of the Apps of the connected Android device.

- Unlock your Android device beforehand.

Preparation:

Select [Android Auto] for the <Android Mode Select> setting (page 11).

To change the source from the others

Touch [Android Auto] on the source/option selection screen (page 12).

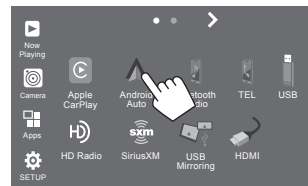

Eg. Source/option selection screen for DMX8095

The Android Auto screen is displayed.

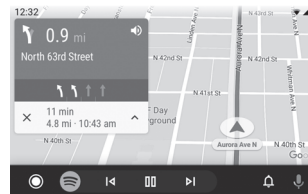

Apps

■ Operation buttons on the Android Auto screen

You can perform the operations of the Apps of the connected Android device. The items displayed on the screen differ among the connected Android device.

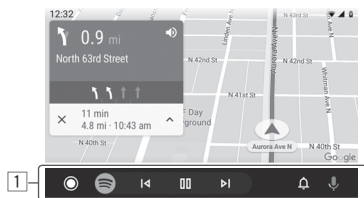

- 1 Application/information buttons
Starts the application or displays information.

To exit the Android Auto screen

Press the **HOME** button on the monitor panel.

■ Using voice guidance of the Android device

You can activate the voice guidance of the Android device while the Android Auto screen is displayed.

1 Press the **VOICE** button on the monitor panel.

The voice guidance is activated.

2 Speak to the microphone to operate the Android device.

To cancel the voice guidance, press the **VOICE** button. Each time you press the button, the voice guidance turns on and off.

Using the Apps of an Android device — USB Mirroring

This feature is only used with Android device.

By installing KENWOOD's Mirroring OA App into your Android device, the screen of the Android device is displayed on the monitor panel of this unit, and you can operate the Android device using the touch panel of this unit.

- For details about KENWOOD's Mirroring, visit <<https://www.kenwood.com/cs/ce/>>.

Compatible Android device

Android version 7.0 or later

Installing KENWOOD's Mirroring OA App

You can obtain "Mirroring OA for KENWOOD" in Google Play.

- Make sure to install the most recent version into your Android device.
- When you use "Mirroring OA for KENWOOD" for the first time, the terms of service are displayed. It is necessary to agree to the terms of service to use this feature.

Connecting an Android device with KENWOOD's Mirroring OA App installed

Connect an Android device with KENWOOD's Mirroring OA App installed via both USB and Bluetooth connection (page 6).

■ Starting USB Mirroring

Preparation:

- Unlock your Android device beforehand.
- Make sure that the KENWOOD's Mirroring OA App is installed.
- Select [**Mirroring for Android**] for the <**Android Mode Select**> setting (page 11).

1 Connect the Android device.

- ① Connect the device with Bluetooth.
 - Pair the device with the unit via Bluetooth. See "Pairing a Bluetooth device" on page 7.
 - Select [**USB Mirroring**] on the profile setting of the <**Device List**> screen (page 9).
- ② Then, connect the device with USB.

Then follow steps 2 to 4 below on the Android device screen:

2 Touch the icon of KENWOOD's Mirroring OA App.

3 Touch [OK] to start KENWOOD's Mirroring OA App.

4 Touch [Start now] to capture the Android device screen to the screen of this unit.

5 Touch [USB Mirroring].

On the source/option selection screen (page 12):

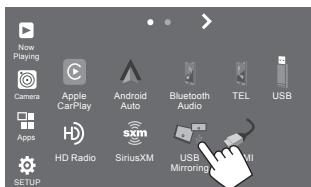

Eg. Source/option selection screen for DMX809S

The Android device screen is displayed on the monitor screen of this unit. You can access your Android device from this unit.

To exit the Android device screen

Press the **HOME** button on the monitor panel.

USB

Playback operations

Start playing the USB

All files in the USB device will be played repeatedly until you change the source or disconnect the USB device.

• When no USB device is connected:

Connect a USB device to the USB terminal.

The playback source changes to **[USB]** and playback starts.

• When a USB device is already connected:

Select **[USB]** as the source.

From the Home screen (page 3), touch as follows:



Playback information and key operation

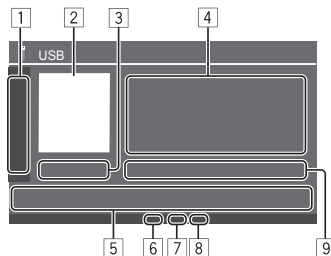

1 Displays/hides the following operation keys

[] [+] Selects a folder.

[] Selects repeat playback mode by touching repeatedly.*

[MODE] Displays the <USB Mode> screen.

2 Jacket picture (artwork) is shown if any

3 Playing time/playback status

4 Content information

- Touching [<] scrolls the text if not all of the text is shown.

5 Operation keys

[] Displays the <Equalizer> screen (page 42).

[Q] Displays the search method selection window.

[<<] / [>>]

- (Touch) Selects a file.
- (Hold) Reverses/forwards search.

[] Starts/pauses playback.

[] Selects random playback mode.*

6 Repeat/Random mode indicator

7 File type indicator (MUSIC/MOVIE/PICTURE)

8 Playlist (PLIST) indicator: displayed when Category List/Link Search is selected.

9 Current playback file information (file type/folder no./file no.)

* You cannot activate repeat playback mode and random playback mode at the same time.

■ Selecting the file type to play

You can specify the file type to play.

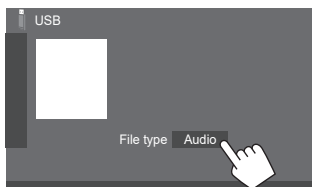

Select the file type as follows:

[Audio]	Plays back audio files.
[Video]	Plays back video files.
[Photo]	Plays back still picture files (Slide Show). You can select the picture to use for display background (see <User Customize> on page 47).

- If the USB contains no files of the selected type, the message "No File" appears. In this case, select the correct file type.

■ Video playback operations

While watching a video, you can use the following features.

■ Touch screen operations

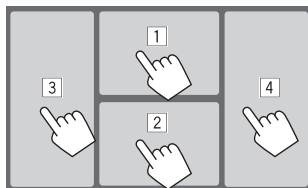

Touching the numbered areas above performs the following actions:

- 1 Displays the video menu control.
- 2 Displays the video source control screen.
- 3 Goes to the previous file.
- 4 Goes to the next file.

■ Video menu control

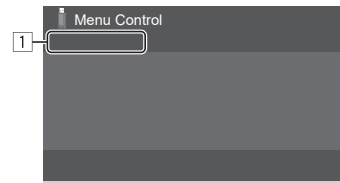

Touching the operation keys performs the following actions:

1

- [Aspect]** Displays the <Aspect> screen.
- Touch **[Aspect]** to select the aspect ratio.

<Full>: For 16:9 original pictures
4:3 signal 16:9 signal



<Normal>: For 4:3 original pictures
4:3 signal 16:9 signal



<Auto>: The aspect ratio is automatically selected to match the incoming signals.

[Picture Adjust] Displays the <Screen Adjustment> screen.

- ① Touch **[DIM ON]** or **[DIM OFF]** to turn on or off the dimmer.
 - ② Touch **[+]/[-]** to adjust the other items.
- **<Contrast>**: Adjusts the contrast (-10 to +10).
 - **<Bright>**: Adjusts the brightness (-15 to +15).
 - **<Color>**: Adjusts the color (-10 to +10).
 - **<Tint>**: Adjusts the tint (-10 to +10).

Video source control screen

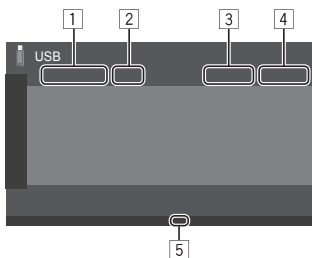

- 1 File type
- 2 Playback status
- 3 Current playback folder no./file no.
- 4 Playing time
- 5 Playback mode indicator (Repeat/Random)

Search operations

You can search files to play.

1 Display the search method selection screen.

On the source control screen:



2 Select the search method.

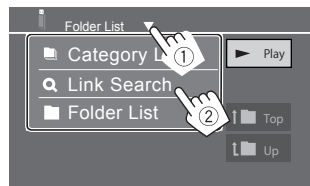

[Category List] Search a file by its category (only for audio files).

[Link Search] Search a file of the same artist/album/genre with the audio file currently selected.

[Folder List] Select a file in the folder list.

3 Follow the following procedure for <Category List>, <Link Search> and <Folder List>.

- For list screen operations, see also page 14.

<Category Search>

This is only used for audio files.

- To change the file type, see page 19.

1 Select your desired category.

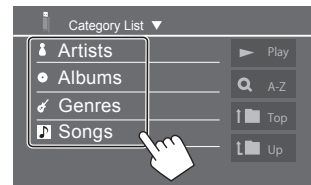

List of the selected category appears.

2 Select your desired file on the list.

<Link Search>

This is only used for audio files.

- To change the file type, see page 19.

1 Select the tag information.

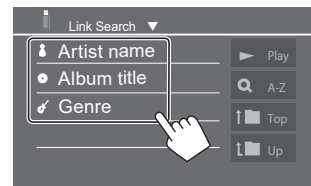

List of the contents containing the same tag with the file currently playing file is displayed.

2 Select your desired file on the list.

<Folder List>

Select the folder, and then the item in the selected folder.

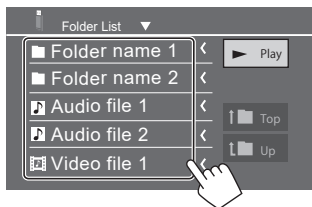

- Touching [**<**] scrolls the text if not all of the text is shown.

Settings for USB playback

1 Display the <USB Mode> screen.

On the source control screen:



2 Make the settings.

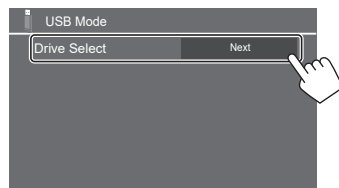

<Drive Select>

- **Next:** Switch between internal memory and the memory source of the connected device (such as mass storage device).

HD Radio™ (for DMX809S)

You can tune in to both HD Radio and conventional FM/AM radio programs.

To find HD Radio stations in your area, visit <http://www.hdradio.com>.

About HD Radio™ Technology

HD2/HD3

Adjacent to traditional main stations are HD2/HD3 Channels, providing new original formats on the FM dial.

Digital Sound

HD Radio broadcasts deliver crystal-clear, CD-like digital audio quality to consumers.

Program Info

Provides song name, artist, station ID, and other relevant data to enrich the listening experience.

Emergency Alerts

Delivers critical and life-saving messages to the public during emergency situation.

Listening to the radio

This unit alarms you emergency when receiving the alarm signals (page 24).

Select [HD Radio] as the source.

From the Home screen (page 3), touch as follows:



The last channel you selected is tuned in, and the source control screen for the channel is displayed.

Playback information on the source control screen

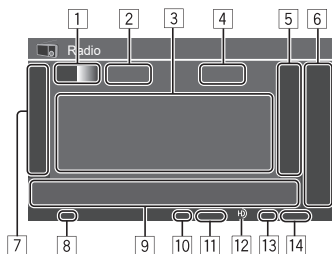

- When receiving the analog signal broadcast, the information on the screen is different from above. See page 25 for the information displayed while receiving analog signals.

- 1 Selects the band (AM/FM1/FM2/FM3)
 - Each time you touch **[FM]**, FM band changes in order of FM1, FM2, and FM3.
- 2 HD Radio sub-channel indicator
- 3 Station (channel) information area
Call letter/Slogan/Artist/PTY/Message
 - Touching **[<]** scrolls the text if not all of the text is shown.
 - Touching **[PTY]** switches between **[PTY]**, **[PS]**, **[Radio Text]** and **[Message]**.
- 4 Current station frequency
- 5 Displays the preset stations window (page 24)
 - To hide the window, touch **[>]**.

- 6 **[P1] – [P5]**
 - (Touch) Selects a preset channel.
 - (Hold) Presets the current channel.
- 7 Displays/hides the following operation keys

[PTY] (For FM stations) Enters PTY search mode.

- ① Touch **[PTY]**.
- ② Touch and hold a PTY code to search for.

If there is a station broadcasting a program of the same PTY code as you have selected, that station is tuned in.

[SEEK] Selects the seek mode for **[<<|]**/**[>>|]**.

- **AUTO1***: (Initial): Auto search
- **AUTO2***: Tunes in preset stations one after another
- **MANU***: Manual search

* This setting also affects the **[CH▲/CH▼]** operation.

[AME↕]	(Hold) Starts auto-memory presetting of the stations.
[MODE]	Displays the <Radio Mode> screen.
[Emergency Alert]	Activates or deactivates Emergency Alert.
[Alert Message Log]	Displays the received alert message log.

8 EA indicator (page 24)

9 Operation keys

[]	Displays the <Equalizer> screen (page 42).
---------	--

[CH▲]/ [CH▼]	Selects a sub-channel when receiving an HD Radio multicast channel.
-----------------	---

[◀◀]/[▶▶]	Searches for a station. <ul style="list-style-type: none"> The search method differs according to the selected setting for [SEEK].
-----------	---

10 ST indicator

- Lights up when receiving a FM broadcast with sufficient strength.

11 Seek mode indicator

12 HD indicator

- Lights up when receiving an HD Radio broadcast.

13 MC indicator

- Lights up when receiving an HD Radio multi-channel broadcast.

14 HD Radio reception mode indicator

- Received signal is indicated — “DIGITAL” or “ANALOG”.

Changing the receive mode

You can change HD Radio receive mode.

1 Display the <Radio Mode> screen.

On the source control screen:



2 Select receive mode.

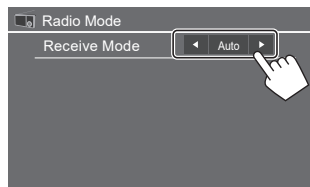

[Auto]	Switches the receiving signal automatically – digital or analog.
--------	--

[Digital]	Select this to tune in to the digital audio signals.
-----------	--

[Analog]	Select this to tune in to the analog audio signals.
----------	---

Presetting stations in the memory

You can preset five stations each for AM and FM1/ FM2/FM3.

Automatic presetting — AME (Auto Memory)

1 Select the band.

On the source control screen:

[AM] / [FM1] — [FM3]



2 Start AME.



The preset stations differ depending on the <Receive Mode> setting.

- When [Digital] is selected, main channels (HD1) of digital broadcasting stations are preset.
- When [Analog] is selected, analog broadcasting stations are preset.
- When [Auto] is selected, both digital and analog broadcasting are preset.

HD Radio™ (for DMX809S)

Manual presetting

You can store either main channel (HD1) or sub-channel (HD2 – HD8) for digital broadcasting stations.

1 Select the band, and then tune in to a station you want to preset.

On the source control screen:

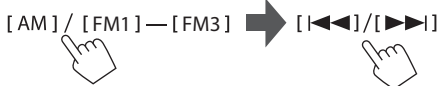

2 Select a desired channel if available.

[CH▲] / [CH▼]



3 Select a preset number to store into.



The station selected in step 1 is stored into the preset number [P1] to [P5] you have selected.

Selecting a preset station

1 Select the band, then display the preset station window.

On the source control screen:

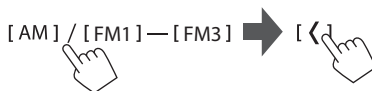

2 Select a preset station.

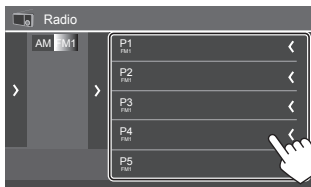

- To show the details of the item, touch [◀].
- You can also select a preset channel by touching [P1] – [P5].

To hide the window: Touch [>].

Using Emergency Alert

You can activate Emergency Alert and check Alert Message log.

Activating Emergency Alert

On the source control screen:



Emergency Alert is activated, and the EA indicator lights up as follows.

- **White:** When the current station supports Emergency Alert.
- **Orange:** When Emergency Alert is not available.
- **Red:** When Emergency Alert is received or snoozed.

To deactivate, touch [Emergency Alert] again.

HD Radio™ (for DMX809S)

When an alert message is received:

The following alert message screen appears.

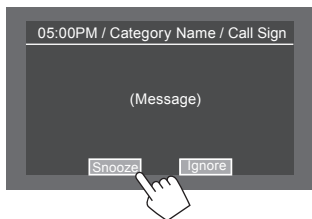

After checking the message, touch **[Snooze]** or **[Ignore]**.

[Snooze] The same alert message does not interrupt again for 10 minutes.

[Ignore] The same alert message does not interrupt again for next 12 hours.

The alert message screen goes off.

■ Checking Alert Message Log

You can confirm the details of the alert messages received.

1 Display the <Alert Message Log> screen.

On the source control screen:



2 Select the emergency alert message to confirm.

- Touching [**<**] scrolls the text if not all of the text is shown.
- For list screen operations, see also page 14.

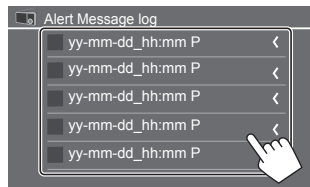

The selected message is displayed. Touch **[Close]** to close the message window.

To deactivate, touch **[Emergency Alert]** again.

Radio (for DMX8709S)

Listening to the radio

This unit alarms you emergency when receiving an alarm signal from FM broadcast.

Select **[Radio]** as the source.

From the Home screen (page 3), touch as follows:



The last station you selected is tuned in, and the source control screen for the station is displayed.

■ Playback information on the source control screen

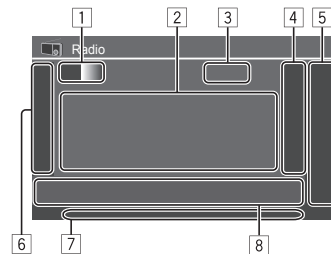

1 Selects the band (AM/FM1/FM2/FM3)

- Each time you touch **[FM]**, FM band changes in order of FM1, FM2, and FM3.

Radio (for DMX8709S)

- 2 Station information area
- Touching [◀] scrolls the text if not all of the text is shown.
 - Touching [Radio Text] switches between [Radio Text], [Radio Text Plus] and [PTY].
- 3 Current station frequency
- 4 Displays the preset stations window (page 27)
- To hide the window, touch [>].
- 5 [P1] – [P5]
- (Touch) Selects a preset station.
 - (Hold) Presets the current station.
- 6 Displays/hides the following operation keys
-
- [AME ↓]** (Hold) Preset the stations automatically.
-
- [MONO]** (For FM stations) Activates monaural mode for better FM reception (stereo effect will be lost). The MONO indicator lights up.
- To deactivate, touch [MONO] again.
-
- [TI]** (For FM RBDS stations) Activates TI Standby Reception mode.
- When TI is activated, the unit is ready to switch to Traffic Information if available. The TI indicator lights up in white.
 - If the TI indicator lights up in orange, tune in to another station providing Radio Broadcast Data System signals.
 - The volume adjustment made for Traffic Information is automatically memorized and used.
 - To deactivate, touch [TI] again.

- 7 Indicators
- **TI**: Lights up in white when receiving the traffic information, and lights in orange when TI Standby Reception is on standby.
 - **ST**: Lights up when receiving a stereo broadcast.
 - **MONO**: Lights up when receiving stations in monaural forcibly.
 - **AUTO1/AUTO2/MANU**: Seek mode indicator
- 8 Operation keys
-
- [||||]** Displays the <Equalizer> screen (page 42).
-
- [PTY]** (For FM RBDS stations) Enters PTY search mode.
- ① Touch [PTY].
 - ② Touch and hold a PTY code to search for.
- If there is a station broadcasting a program of the same PTY code as you have selected, that station is tuned in.
-
- [SEEK]** Selects the seek mode for [◀◀]/[▶▶].
- **AUTO1** (Initial): Auto search
 - **AUTO2**: Tunes in preset stations one after another
 - **MANU**: Manual search
-
- [◀◀]/[▶▶]** Searches for a station.
- The search method differs according to the selected setting for [SEEK] (see above).

Presetting stations in the memory

You can preset five stations each for AM and FM1/FM2/FM3.

Automatic presetting — AME (Auto Memory)

1 Select the band

On the source control screen:

[AM] / [FM1] — [FM3]



2 Start AME.



The local stations with the strongest signals are found and stored automatically.

Radio (for DMX8709S)

Manual presetting

1 Select the band, and then tune in to a station you want to preset.

On the source control screen:

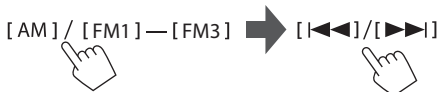

2 Select a preset number to store into.



The station selected in step 1 is stored into the preset number [P1] to [P5] you have selected.

Selecting a preset station

1 Select the band, and then display the preset station window.

On the source control screen:

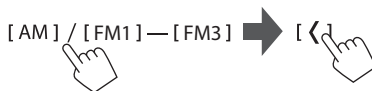

2 Select a preset station.

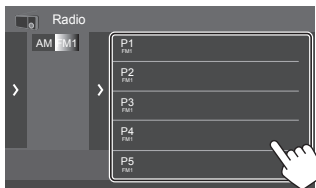

- To show the details of the item, touch [<].
- You can also select a preset channel by touching [P1] – [P5].

To hide the window: Touch [>].

SiriusXM® Satellite Radio

Only SiriusXM® brings you more of what you love to listen to, all in one place. Get over 140 channels, including commercial-free music plus the best sports, news, talk, comedy and entertainment. Welcome to the world of satellite radio. A SiriusXM Connect Vehicle Tuner and subscription are required.

For more information, visit <www.siriusxm.com>.

Connecting SiriusXM Connect Vehicle Tuner

See page 58.

Activating subscription

1 Check your Radio ID.

- The SiriusXM Satellite Radio ID is required for activation and can be found by tuning to Channel 0 as well as on the label found on the SiriusXM Connect Vehicle Tuner and its packaging.
- The Radio ID does not include the letters I, O, S or F.

2 Activate the subscription.

For users in the U.S.A.:

- Online: Visit <www.siriusxm.com/activatenow>
- Phone: Call SiriusXM Listener Care at 1-866-635-2349

For users in Canada:

- Online: Visit <www.siriusxm.ca/activate>
- Phone: Call XM Customer Care at 1-888-539-7474

3 Confirm the activation.

A confirmation message appears. Touch [Return].

SiriusXM® Satellite Radio

Listening to the SiriusXM® Satellite Radio

Select [SiriusXM] as the source.

From the Home screen (page 3), touch as follows:



The last channel you selected is tuned in, and the source control screen for the channel is displayed.

Playback information on the source control screen

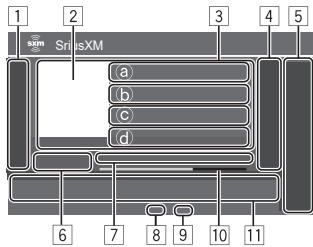

- 1 Displays/hides the following operation keys

[MODE] Displays the <SiriusXM Mode> screen.

[👤+] (Hold) Registers the current artist to the alert contents.

[🎵+] (Hold) Registers the current song to the alert contents.

[📶] Activates or deactivates the content alert for traffic and weather.

[SEEK] Changes the seek mode for **[CH▲]/[CH▼]**.

- **SEEK1** (Initial): Skips to another available channel.
- **SEEK2**: Skips to another preset channel.

[◀◀/▶▶] Controls playback during content replay.

[SCAN] Starts TuneScan™.

[Live] Switches between replay mode and live broadcast.

[Direct Channel] Enter the channel number to select a channel.

[...] Changes the page in the window to display other operation keys.

- 2 Displays album artwork for most SiriusXM music channels (cache real-time images for current channel only)

- 3 Station (channel) information area

a Channel name

Touching **[🕒]** changes the displayed contents in **b**, **c**, and **d** as follows.

b Artist ↔ Category

c Song title ↔ Channel description

d Information ↔ Related channel

- Touching **[<]** scrolls the text if not all of the text is shown.

- 4 Displays the preset channel window (page 30)
- To hide the window, touch **[>]**.

- 5 **[P1] – [P5]**

- (Touch) Selects a preset channel.
- (Hold) Presets the current channel.

- 6 Selects the band (SXM1/SXM2/SXM3/SXM4)
- The channel no. currently selected is displayed.

- 7 Playback status and time code for the buffered data and replay mode

- The time code shows you the point in the replay buffer you are listening to. (Eg. “-5:00” means that you are listening to audio that is 5 minutes behind the current broadcast.)

- 8 SiriusXM signal strength indicator

- 9 Seek mode indicator

- 10 Replay time bar for replay mode

- Gray: The remaining capacity
- Blue: The amount of buffered contents

- 11 Operation keys

[🎚️] Displays the <Equalizer> screen (page 42).

[🔍] Displays the <Channel List> screen.

[▶||] Starts/pauses the content replay.

[CH▲]/[CH▼] Selects the channel.

- To select all Channels, make sure **[SEEK1]** is selected as the seek mode.

- To select only preset channels, make sure **[SEEK2]** is selected as the seek mode.

Selecting a channel

You can select the channel by directly entering channel number or by selecting it on the channel list.

Selecting a channel directly

- When you enter the channel number of parental-locked channel (page 33), the **<Parental Code Check>** screen appears. Enter the correct parental code to access the channel.

1 Display the **<Direct Channel>** entry screen.

On the source control screen:

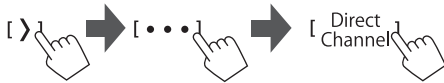

2 Enter the channel number (1), and then confirm (2).

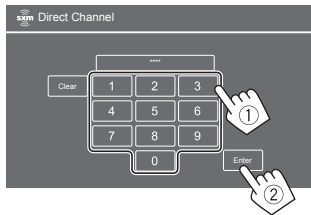

- To correct misentry, touch **[Clear]**.

Selecting a channel on the list

1 Display the **<Channel List>** screen.

On the source control screen:



2 Select a category (1), and then select a channel (2).

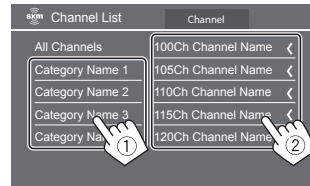

- To list all the channels, touch **[All Channels]**.
- Touch the info change key above the list (**[Channel]/[Artist]/[Song Title]/[Info]**) to change the list.

Presetting channels in the memory

You can preset five channels for each band.

1 Select the band, and then tune in to a channel you want to preset.

On the source control screen:

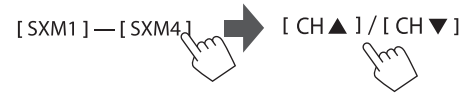

2 Select a preset number to store into.



The channel selected in step 1 is stored into the preset number **[P1]** to **[P5]** you have selected.

Selecting a preset channel

1 Select the band, and then display the preset channel window.

On the source control screen:



2 Select a preset channel.

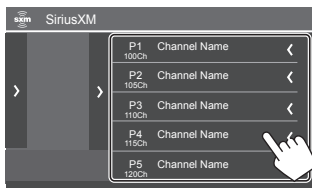

- To show the details of the item, touch [◀].
- You can also select a preset channel by touching [P1] – [P5].

To hide the window: Touch [>].

- You can also select the preset channels by touching [CH▲]/[CH▼] (page 28).

Replaying content

You can pause, rewind and replay the contents of the currently tuned channel.

- The SiriusXM Connect Vehicle Tuner continually buffers up to 60 minutes of audio.
- If you change to another channel during replay, the buffered contents will be lost.
- The time code is updated every second.

1 Display the operation keys for replay.

On the source control screen:

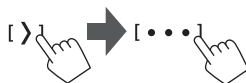

2 Perform the replay operations.

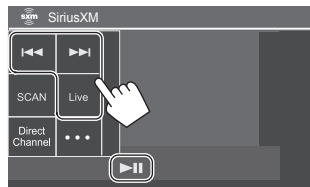

[▶]	Starts/pauses playback.
[◀◀]/[▶▶]	Skips the current track. <ul style="list-style-type: none"> • Touching [◀◀] within 2 seconds of the beginning of the current track returns to the previous track. • Touching [◀◀] after 2 seconds or more of the current track returns to the beginning of the track.
(Hold)	Reverses/forwards search.
[Live]	Returns to the live (current broadcast) position.

SiriusXM Satellite Radio features

SmartFavorites

(Available for SXV200 or later)

User stored channels (P1 to P5) are recognized as SmartFavorites channels. SiriusXM Connect Vehicle Tuner automatically buffers their broadcast content. When you select a SmartFavorites channel, you can rewind and replay up to 30 minutes of any of the missed news, talk, sports or music content.

- While SmartFavorites channel is tuned in, the album artwork of the playback song is displayed on the screen if any. If not available, station logo, channel logo, etc. will be displayed.
- If you change to another band, the buffered content is cleared.

TuneStart™

When you select a SmartFavorites channel, you can listen to the current song from the beginning.

1 Display the <SiriusXM Mode> screen.

On the source control screen:



2 Activate TuneStart.

On the <SiriusXM Mode> screen, touch as follows:
<TuneStart> : [ON]

To deactivate TuneStart: Touch [OFF] in step 2.

TuneScan™

You can get a short preview of the songs you have missed on each of your SmartFavorites music channels and the currently tuned music channel.

Activate TuneScan to start scanning the first 6 seconds of the recorded music contents.

Start TuneScan.

On the source control screen:



The unit starts scanning.

- The ► icon is displayed on the screen when TuneScan is activated.

- To select the previous/next music content, touch [◀◀] or [▶▶].
- To end scanning and continue listening to the current music content, touch [SCAN].
- To exit scanning, touch and hold [SCAN].

Content Alert

The unit informs you when receiving the content you are interested in, such as music, information about a sports team, weather and traffic information.

- For list screen operations, see also page 14.

Registering items for Contents Alert

You can register your favorite artists, songs or teams. Up to 50 contents can be registered.

For artists/songs

While listening to your favorite artist/song:

On the source control screen:



Touching the operation keys performs the following actions:

[👤+]	(Hold) Registers the artist of the current song.
[🎵+]	(Hold) Registers the current song.

For teams

1 Display the <SiriusXM Mode> screen.

On the source control screen:



2 Display the <Alert Team Select> screen.

On the <SiriusXM Mode> screen, touch as follows:
<Alert Team Select> : [Enter]

3 Select the league (①) and the team (②), then register into the content alert (③).

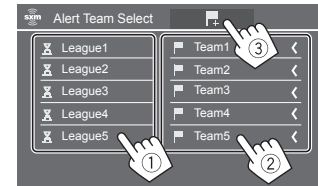

- To show the details of the item, touch [<].

SiriusXM® Satellite Radio

■ Selecting items for Content Alert

You can select items (artists/songs/teams) on the list, so that this unit informs you once the selected item starts being broadcast.

• For artists/songs/teams

1 Display the <SiriusXM Mode> screen.

On the source control screen:



2 Display the <Content Alerts Contents Set> screen.

On the <SiriusXM Mode> screen, touch as follows:
<Content Alerts Contents Set> : [SET]

3 Select the category (①), then the item (②).

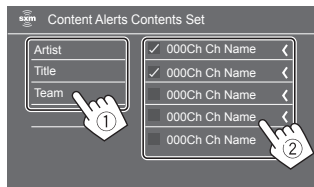

A check mark appears beside the selected item.

- To show the details of the item, touch [<].

To delete the registered items: Touch and hold the item you want to delete in step 2.

The [🗑️] icon and a check mark appear beside the selected item. Touch the [🗑️] icon to delete.

To delete all registered contents: Touch and hold [All Clear ⏏️] for <Content Alerts Contents Set> in step 2.

• For traffic and weather information

1 Display the <SiriusXM Mode> screen.

On the source control screen:



2 Select the city you desire traffic and weather information for.

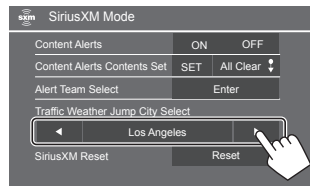

- When traffic and weather starts being broadcast, this unit automatically switches the channel broadcasting the information.

■ Activating Content Alert

• For artists/songs/teams

1 Display the <SiriusXM Mode> screen.

On the source control screen:



2 Activate Content Alert.

On the <SiriusXM Mode> screen:
<Content Alerts> : [ON]

To deactivate Content Alert: Touch [OFF] in step 2.

• For traffic and weather information

Make sure <Content Alerts> is set to [ON].

On the source control screen:

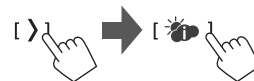

To deactivate the Content Alert: Touch [🔔] again.

Switching to your favorite content

• For artists/songs/teams

When the contents of artist/song/team registered for Content Alert is being broadcast, an alert appears on the screen.

Touch [Jump], and then select the item to jump to on the <Content Alerts> screen.

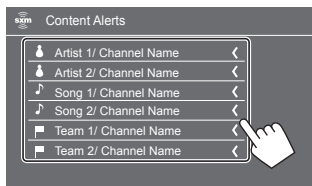

• To show the details of the item, touch [<].

• For traffic and weather information

When a traffic and weather information for the selected city status being broadcast, the unit automatically switches the channel.

Setting reception restrictions

You can limit access to SiriusXM channels, such as those with mature content.

Changing the parental code

- The initial setting is "0000".
- Changing the code does not change the <Parental Control>/<Parental Lock Channel Selection> settings.

1 Display the <SiriusXM Mode> screen.

On the source control screen:



2 Display the <Parental Code Check> screen.

On the <SiriusXM Mode> screen, touch as follows: <Parental Code> : [Change]

3 Enter the four-digit code (initial: 0000) (①), and then touch [Enter] (②) to confirm.

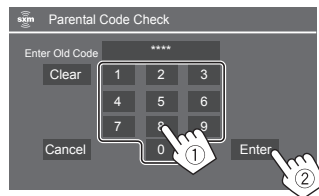

- To clear the last entry, touch [Clear].
- To cancel setting the code, touch [Cancel].

4 Enter a new four-digit code, and then touch [Enter] to confirm.

5 Repeat step 4 to confirm the new code.

Activating parental control

You can set the parental control feature to lock any SiriusXM channels or automatically lock all channels classified as "mature" by SiriusXM.

1 Display the <SiriusXM Mode> screen.

On the source control screen:

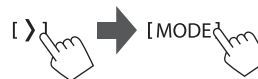

2 Select the desired mode for <Parental Control>.

[OFF]	Deactivates parental control.
[Mature]	Locks channels classified as "mature" by SiriusXM.
[User]	Locks selected channels. • To lock channels, see page 34.

3 Enter the parental code to confirm your selection.

SiriusXM® Satellite Radio

■ Parental Lock channel selection

This option allows you to manually select the channels to be locked by the parental control feature.

- You can only change the setting if <Parental Control> is set to [User].

1 Display the <SiriusXM Mode> screen.

On the source control screen:



2 Display the <Parental Lock Channel Selection> screen.

On the <SiriusXM Mode> screen, touch as follows:
<Parental Lock Channel Selection> : [SET]

3 Enter the parental code.

The <Parental Lock Channel Selection> screen appears.

4 Select a category (①), and then a channel (②).

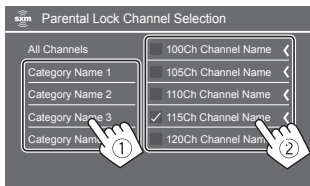

A check mark appears beside the selected channel.

- To show the details of the item, touch [<].
- To list all the channels, select [All Channels].

5 Repeat step 4 to set the parental lock on multiple channels.

To deactivate parental lock for all locked channels:

Select [All Clear] for <Parental Lock Channel Selection> in step 1, then enter the parental code.

■ Skipping unwanted channels

If you do not want to receive some channels, you can skip them.

1 Display the <SiriusXM Mode> screen.

On the source control screen:



2 Display the <Skip Channel Selection> screen.

On the <SiriusXM Mode> screen, touch as follows:
<Skip Channel Selection> : [SET]

3 Select a category (①), and then a channel (②).

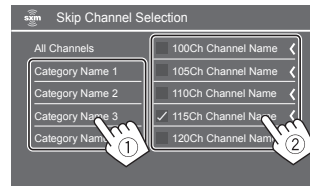

A check mark appears beside the selected channel.

- To show the details of the item, touch [<].
- To list all the channels, select [All Channels].

4 Repeat step 3 to skip multiple channels.

To clear the channel skipping for all skipped channels: Touch and hold [All Clear ↓] for <Skip Channel Selection> in step 2.

Resetting the SiriusXM Satellite Radio settings

You can reset all the SiriusXM settings you made and restore the initial settings.

1 Display the <SiriusXM Mode> screen.

On the source control screen:



2 Reset the settings.

On the <SiriusXM Mode> screen, touch and hold as follows:

<SiriusXM Reset> : [Reset ↓]

Other External Components

HDMI/AV-IN devices

■ Connecting external components

See page 58.

■ Using the HDMI device

When using the HDMI device, you cannot use wireless Apple CarPlay and wireless Android Auto.

Preparation:

- Select **[HDMI]** for the **<Wireless/HDMI SETUP>** setting when using the HDMI device connected to the HDMI terminal (page 51).

1 Select **[HDMI]** as the source.

From the Home screen (page 3), touch as follows:



- If **<Wireless/HDMI SETUP>** is not set to **[HDMI]**, the confirmation screen appears. Touch **[HDMI]** and then touch **[OK]** on the confirmation screen.

2 Turn on the connected HDMI device and start playing the source.

■ Using the AV-IN component

Preparation:

- Select **[AV-IN]** for the **<AV Input>** setting when connecting the external AV device to the AV-IN terminals (page 49).

1 Select **[AV-IN]** as the source.

From the Home screen (page 3), touch as follows:



- When selecting **[Camera]** for the **<AV Input>** setting (page 49), you cannot select **[AV-IN]**.

2 Turn on the connected component and start playing the source.

■ Video menu control

You can display the video menu control while watching the video from the external components.

Touch the upper portion of the screen.



The **<Menu Control>** screen appears.

[Aspect]

Only for **[AV-IN]**: Displays the **<Aspect>** setting screen.

- Touch **[Aspect]** to select the aspect ratio.

<Full>: For 16:9 original pictures
4:3 signal 16:9 signal



<Normal>: For 4:3 original pictures
4:3 signal 16:9 signal



[Picture Adjust]

Displays the **<Screen Adjustment>** screen (page 48).

Cameras

Install the cameras (separately purchased) in the appropriate position according to the instructions supplied with the cameras.

■ Connecting a front/rear view camera

See page 58.

- To use the rear view camera, a reverse lead (REVERSE) connection is required (page 59).
- When connecting the front/rear view camera, set the **<Front Camera>** and **<Rear Camera>** settings correctly (pages 48 and 49).

Other External Components

■ Connecting a camera to the AV-IN terminals

See page 58.

- When connecting the external camera to the AV-IN terminals, select [**Camera**] for the <AV Input> setting (page 49).

For the rear view camera: The rear view screen is displayed by shifting the gear to the reverse (R) position when <Rear Camera Interruption> is set to [ON] (page 49).

- A caution message appears on the screen. To remove the caution message, touch the screen.

For the front view camera: The front view screen is displayed by releasing the gear from the reverse (R) position when <Front Camera Interruption> is set to other than [OFF] (page 49).

■ Watching camera view

1 Display the camera view.

From the Home screen (page 3), touch as follows:



The camera view screen of one of the connected camera is displayed.

2 Change the camera view.

Touch the upper portion of the screen shown below.



- Each time you touch, camera view changes among front view camera, rear view camera, and AV-IN camera.

To display parking guide line

(Only for the rear view camera)

Touch the area shown below, or set <Parking

Guidelines> to [ON] (page 49).



- To close the parking guidelines, touch the same area again.

To exit the camera screen

Press the **HOME** button on the monitor panel or touch the area shown below.



- When the gear is released from the reverse (R) position, the screen also returns to the previous playback source screen.

Using an external component via ADS adapter — OEM Features

By connecting this unit to the bus system of the vehicle using iDatalink (commercially available), this unit can access the satellite radio source provided for the vehicle and vehicle information can be displayed on this unit.

- Displayable screens, key names, and screen names vary depending on the type of the connected iDatalink and the model of the vehicle.
- For details, visit <www.idatalink.com/>.

■ Connecting an ADS adapter

See page 58.

■ Using an external component via an ADS adapter

- For settings to use an ADS adapter, see page .51

1 Select “OEM Features” as the source.

From the Home screen (page 3), touch as follows:



Other External Components

[Satellite Radio]	Displays the control screen of the satellite radio source provided for the vehicle.
[Media Player]	Displays the control screen of the media player source provided for the vehicle.
[TEL]	Displays the control screen of the Bluetooth hands-free function provided for the vehicle.
[BT Streaming]	Displays the control screen of the Bluetooth streaming function provided for the vehicle.
[Gauges]	Displays the information about the instruments such as a speedometer.
[Climate]	Displays the information about the air conditioner of the vehicle.
[Parking Assist]	Displays the information about the Parking Distance Sensor of the vehicle.
[Vehicle Info]	Displays the information about the tire pressures of the vehicle.
[Radar Detector]	Displays the information about the Radar Detector.

2 Select the information you want or the playback source to play.

- When you select the playback source, turn on the connected component and start playing the source.

Bluetooth® Device

You can use the mobile phone and portable audio player connected through Bluetooth.

- While using Apple CarPlay, Android Auto, or USB Mirroring, use their features for hands-free phones and audio playback. (The Bluetooth device currently connected is disconnected when an iPhone with Apple CarPlay or an Android device with Android Auto is connected.)

Note

- While driving, do not perform complicated operations such as dialing numbers, using the phone book, etc. When you perform these operations, stop your car in a safe place.
- To use the Bluetooth function, you need to turn on the Bluetooth function of the device.
- Some Bluetooth devices may not be used with this unit depending on the Bluetooth version of the device.
- When a Bluetooth mobile phone is connected, the signal strength and battery level are displayed when the information is acquired from the device.
- If your mobile phone supports PBAP (Phone Book Access Profile), you can display the following items on the touch panel when the mobile phone is connected.
 - Phone book
 - Dialed calls, received calls, and missed calls (up to 100 entries in total)
- Two devices for Bluetooth mobile phone and one for Bluetooth audio can be connected at a time. However, when **[Bluetooth Audio]** is selected as the source, you can connect up to five Bluetooth audio devices and switch between these five devices.

Bluetooth mobile phone

When a call comes in, this unit automatically enters **[TEL]**, and when it ends, go back to the previous source.

■ When a call comes in...

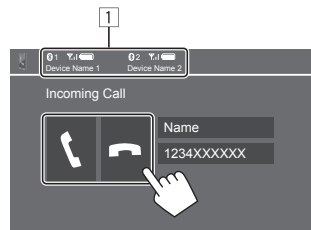

1 Phone device information

- Either hands-free phone 1 or 2 is highlighted to indicate which phone is ringing when a call comes in.

Touching the operation keys performs the following actions:

 Answers a call.



 Rejects a call.

- Call information is displayed if acquired.
- Phone operation is not available while the picture from any camera is displayed.

■ During a call...



Touching the operation keys performs the following actions:

[]	Ends a call.
[] / []	Switches between hands-free mode and phone mode.
[DTMF]	Enters DTMF (Dual Tone Multi Frequency). You can send a text using the keypad.
NR LEVEL [-] / [+]	Adjusts the noise reduction level. (-5 to 5)
EC LEVEL [-] / [+]	Adjusts the echo volume level. (-5 to 5)
MIC LEVEL [-] / [+]	Adjusts the volume level of the microphone. (-10 to 10)

- Press the VOL ▲/▼ buttons on the monitor panel to adjust the volume of the call or earpiece.

■ Making a call

1 Display the phone control screen.

From the Home screen (page 3), touch as follows:



2 Select which phone to use if two mobile phones are connected.

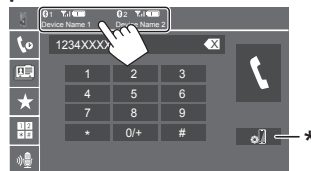

The active device is highlighted.

* Displays the <Connections SETUP> screen (page 11).

3 Select a method to make a call (1 – 5).



- 1 From the call history* (missed calls/received calls/dialed calls)
- 2 From the phone book*
- 3 From the preset list
- 4 Use direct number entry
- 5 Use voice dialling

* Applicable only for mobile phone compatible with PBAP (Phone Book Access Profile).

4 Select a contact (1), then make a call (2).

• When item 1, 2 or 3 is selected in step 2:

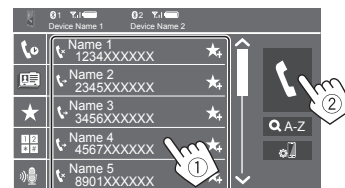

To use alphabet search in the phone book

- 1 Touch [ Q A-Z].
- 2 Touch the first letter you want to search for on the keypad.
To search for a number, touch [1,2,3...].
- 3 Select a contact you want to call from the list.

Phone book search results:

“Sort order”, “display order” or any other equivalent settings of the phone may affect and show different search results (page display).

To display other phone numbers in the same contact

You can store up to ten phone numbers per contact.

- ① Touch [**>**].
- ② Select a contact you want to call from the list.

• When item ④ is selected in step 3:

Enter the phone number (①), then make a call (②).

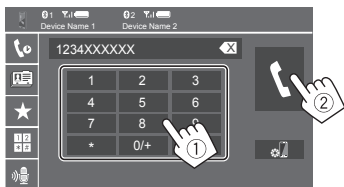

- To enter "+", touch and hold [**0/+**].
- To delete the last entry, touch [**X**].

• When item ⑤ is selected in step 3:

Say the name of the person you want to call.

- Available only when the connected mobile phone has a voice recognition system.
- If the unit cannot find the target, "Please speak into the microphone" appears. Touch [**Start**], and then say the name again.
- To cancel voice dialling, touch [**Cancel**].

■ Presetting phone numbers

You can preset up to five phone numbers.

1 Display the phone control screen.

From the Home screen (page 3), touch as follows:



2 Select which phone to use if two mobile phones are connected.

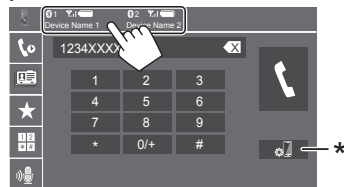

The active device is highlighted.

* Displays the <Connections SETUP> screen (page 11).

3 Select call history or phone book (①), and then select a contact (②) to preset.

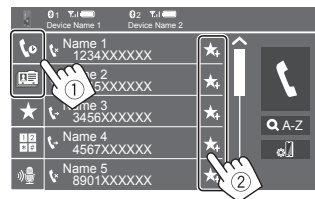

4 Select a preset number to store into.

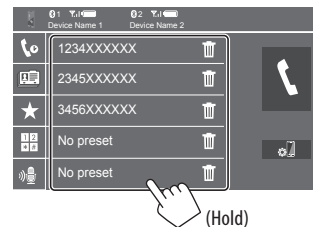

To delete the contact in the preset number: Touch [**X**] besides the contact on the preset list.

Bluetooth mobile phone settings

You can change various settings for using Bluetooth devices on the <TEL SETUP> screen.

1 Display the <TEL SETUP> screen.

From the Home screen (page 3), touch as follows:

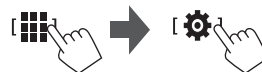

Then, on the <Setup> screen, touch as follows:

[**System**] → <Connections SETUP> : [**Enter**] → <TEL SETUP> : [**Enter**].

On the <TEL SETUP> screen, you can change and confirm the following items.

2 Make the settings.

<Auto Response>

- **ON:** The unit answers the incoming calls automatically in 5 seconds.
- **OFF (Initial):** The unit does not answer the calls automatically. Answer the calls manually.

<Auto Pairing>

- **ON (Initial):** Bluetooth devices are automatically paired.
 - For iPhone with Apple CarPlay and Android device with Android Auto: When the device is connected via USB, it is automatically paired regardless of this setting
- **OFF:** Cancels. (Not available)

<Auto Connect>

- **ON (Initial):** Automatically establishes a connection with the already registered Bluetooth device when the unit is turned on.
- **OFF:** Cancels.

<Bluetooth HF/Audio>

Select the speakers used for Bluetooth mobile phones and Bluetooth audio players.

- **Front Only:** Front speakers only.
- **All (Initial):** All speakers.

Bluetooth audio player

Select [Bluetooth Audio] as the source.

From the Home screen (page 3), touch as follows:



The <Bluetooth Audio> screen is displayed.

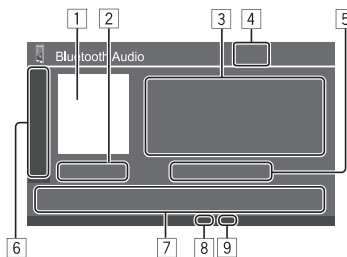

- 1 Jacket picture (artwork) is shown if any
- 2 Playing time/playback status
- 3 Tag data* (current file title/artist name/album title)
 - Pressing [**<**] scrolls the text if not all of the text is shown.
- 4 Signal strength and battery level
(Appears only when the information is acquired from the device.)
- 5 Device name
 - Touching the device name shows the <KENWOOD Music Mix> screen (page 41).

- 6 Displays/hides other available operation keys

[**⏮**] Selects random playback mode.

[**⏮**] Selects repeat playback mode by touching repeatedly.

[**⚙**] Displays the <Connections SETUP> screen (page 11).

- 7 Operation keys

[**📊**] Displays the <Equalizer> screen (page 42).

[**🔍**] Displays the category list.

[**⏪**]/[**⏩**] • (Touch) Selects a file.
• (Hold) Reverses/forwards search.

[**▶**] Starts playback.

[**⏸**] Pauses playback.

- 8 Repeat mode indicator
- 9 Random mode indicator

* Available only for devices compatible with AVRCP 1.3.

Bluetooth® Device

■ Selecting an audio file from the menu

1 Display the audio menu.

On the source control screen:



2 Select a category (①), and then select a desired item (②).

- For list screen operations, see also page 14.

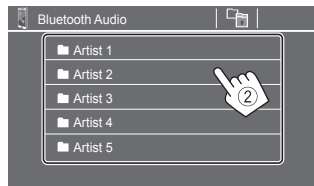
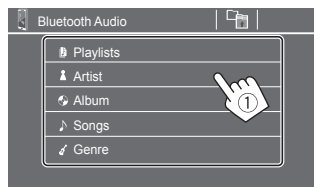

Select an item in each layer until you reach and select the desired file.

■ KENWOOD Music Mix

You can connect up to five Bluetooth audio devices at the same time. You can easily switch between these five devices by playing music from the device.

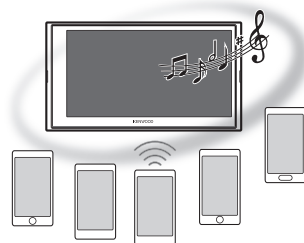

1 Display the device list for KENWOOD Music Mix.

On the source control screen:

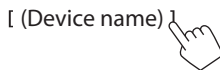

List of the registered devices is displayed.

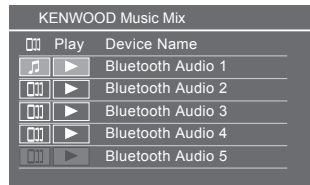

2 Select the device (①) and start playback (②).

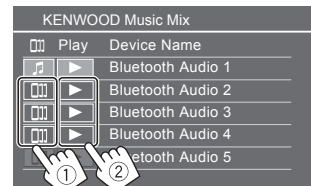

The selected device starts playback.

The meaning of the icons and their colors:

Icon	Meaning
	Device used currently for <Bluetooth Audio>. <ul style="list-style-type: none"> • Touch to display the <Device List> screen (page 9).
*	Devices ready for KENWOOD Music Mix. <ul style="list-style-type: none"> • Touch to select the playback device.
*	Touch to start playing back the selected device. <ul style="list-style-type: none"> • When the playback starts, the background of the icon becomes blue.

* When the icon and background color are gray, the device is not available.

Settings

Audio settings

1 Display the <Audio> screen.

On the source/option selection screen (page 12):



Then, on the <Setup> screen, touch as follows:
[Audio] (①) → [Enter] for the item you adjust (②).

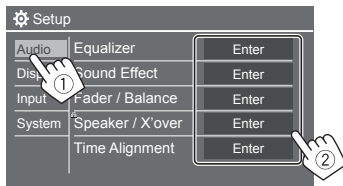

2 Adjust the item.

The <Audio> settings are not adjustable;

- When the unit is in standby (STANDBY).
- When the Bluetooth phone is used (making or receiving a call, during a call, or while voice dialling).
- When Apple CarPlay or Android Auto is used for phone calling.

<Equalizer>

The following adjustments are memorized for each source until you adjust the sound again.

■ Selecting a preset sound mode

Select a preset sound mode on the <Equalizer> screen (①).

- Pops/Easy/Top40/Jazz/Powerful/Rock/Flat (Initial)/Bass Boost/User1/User2/User3/User4

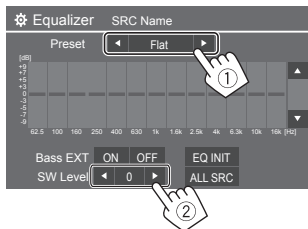

<SW Level>

Adjusts the subwoofer level (②).

- Not adjustable when <None> is selected for subwoofer on the <Speaker Select> screen (page 44).
- -50 to +10 (Initial: 0)

To apply the adjusted equalizer to all playback sources, touch [ALL SRC], and then touch [OK] to confirm.

■ Store your own sound adjustments

- 1 Select one of the User mode (User1 – User4) to store your adjustment into.
- 2 Select a band (①), adjust the level (②), and then adjust the sound (③).

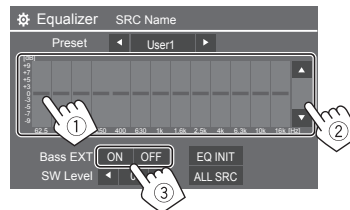

- Repeat ① and ② to adjust the level of other bands. Finally adjust the following items.

<Bass EXT>

Activates/deactivates bass.

- ON/OFF (Initial)

To clear the adjustment, touch [EQ INIT].

- Once the adjustment screen is closed, your adjustment is memorized.

Settings

<Sound Effect>

Adjust the sound effect.

<Loudness>

Adjusts loudness.

- OFF (Initial)/Low/High

<Bass Boost>

Selects the bass boost level.

- OFF (Initial)/Level 1/Level 2/Level 3

<Drive Equalizer>

Reduces the driving noise by raising the bandwidth.

- OFF (Initial)/ON

<Space Enhancer>

Virtually enhances the sound space using the Digital Signal Processor (DSP) system (except for Digital Radio and Radio).

Select the enhance level.

- OFF (Initial)/Small/Medium/Large

<Supreme>

Compensates the sound lost while audio compression process (except for analog signals).

- OFF/ON (Initial)

<Realizer>

Virtually makes the sound more realistic using the Digital Signal Processor (DSP) system. Select the sound level.

- OFF (Initial)/Level 1/Level 2/Level 3

<Stage EQ>

Moves the center of the sound to the lower or higher point. Select the height.

- OFF (Initial)/Low/Middle/High

<Fader/Balance>

Touch [▲]/[▼]/[◀]/[▶] or drag the  mark to adjust.

<Fader>

When <X'over Network> is set to [2 way], you can adjust the front and rear speaker output balance.

- F15 to R15 (Initial: 0)

<Balance>

Adjusts the left and right speaker output balance.

- L15 to R15 (Initial: 0)

To clear the adjustment: Touch [Center].

<Speaker/X'over>

Preparation:

Before making the adjustment for <Speaker/X'over>, select the appropriate crossover network mode according to the speaker system (2-way speaker system or 3-way speaker system).

1 Put the unit in standby.

From the Home screen (page 3), touch as follows:



2 Display the <X'over Network> screen.

Press the VOL ▼ button on the monitor panel and touch the upper right portion on the touch panel at the same time:



3 Select the crossover network mode.

[2 way] Select this when 2-way system speakers are used (front/rear/subwoofer).

[3 way] Select this when 3-way system speakers are used (tweeter/mid range/subwoofer).

A confirmation message appears. Touch [Yes].

Settings

Now, you can adjust the <Speaker/X'over> settings.

- 1 Display the <Setup> → <Audio> → <Speaker/X'over> screens (page 42).
- 2 Select a car type (1), select the location of the speakers (2)*, and then display the <Speaker Select> screen (3).

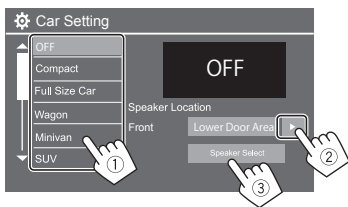

* <Speaker Location> is available only when <X'over Network> is set to [2 way].
<Speaker Location> for rear speakers is only available when the rear speakers are selected for <Speaker Select>.

- 3 Select the speaker type (1), select the size of the selected speaker (2), and then display the <X'over> screen (3).

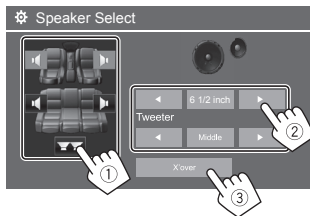

- If a speaker is not connected, select [None].
- When setting the front speakers, select the speaker size for <Tweeter>.

- 4 Adjust the crossover frequency of the selected speaker.

- Adjustable items vary depending on the selected speaker type/speaker size/crossover settings.

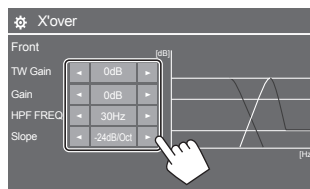

Eg. when adjusting <X'over> for front speakers

<Gain>/<TW Gain>

Adjusts the output volume of respective speaker.

<HPF FREQ>/<LPF FREQ>

Adjusts the crossover frequency for respective speaker.

<Slope>

Adjusts the crossover slope for respective speaker.

<Phase>

Selects the phase for the speaker.

<Time Alignment>

This setting improves the sound field for the seats you select.

<Position>

You can select either <Listening Position> or <Front Focus> on the screen. You cannot use both setting at the same time.

Settings

<Listening Position>

This setting is used for both 2-way speaker system and 3-way speaker system.

1 Specify your favorite listening position.

- ① Touch **[Listening Position]**.
- ② Select the listening position – **[All]** (Initial), **[Front L]**, **[Front R]** or **[Front All]***.
- ③ Touch **[Adjust]**.

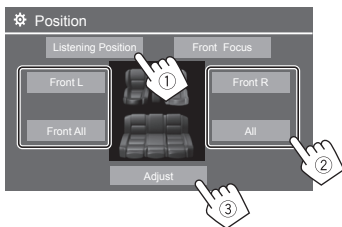

* [Front All] is selectable only when <X'over Network> is set to [2 way].

2 Touch **[Distance]** (①), and then enter the distance from your listening position to each speaker (②).

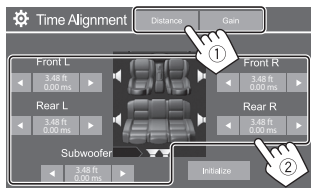

3 Touch **[Gain]** (①), and then adjust the sound level of each speaker (②).

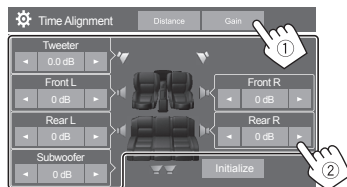

To initialize the setting value: Touch **[Initialize]**.

Determining the delay time adjustment

If you specify the distance from the center of your listening position to every speaker, the delay time is automatically computed and set.

Eg. When **[Front All]** is selected as the listening position

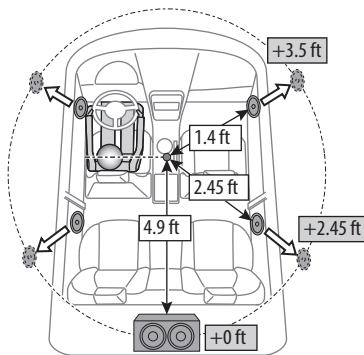

<Front Focus>

When you select 2-way speaker system, you can use this setting, enabling you to focus the imaginary sound localization for the seat you select.

1 Select the listening position.

- ① Touch **[Front Focus]**.
- ② Select from **[Front L]**, **[Front R]**, **[Front All (Priority L)]**, **[Front All (Priority R)]**, **[All (Priority L)]**, or **[All (Priority R)]**.
 - “Priority” means to which seats (left or right) the sound localization tends to be shifted.
- ③ Touch **[Adjust]**.

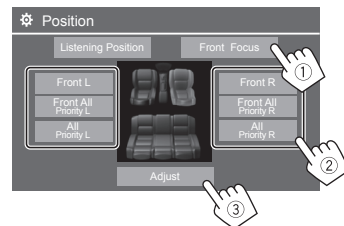

2 Touch [Distance] (①), and then adjust the following parameters (②).

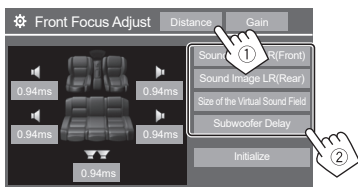

[Sound Image LR (Front)]

Locates the sound image in front of the front seats, and adjust the balance.

- You can mute the sounds of the rear speakers and subwoofer.

[Sound Image LR (Rear)]

Locates the sound image in front of the rear seats, and adjust the balance.

[Size of the Virtual Sound Field]

Adjusts the virtual sound field to the desired field size.

- If the sound image moves out of the front position, adjust **[Sound Image LR (Front)]**/**[Sound Image LR (Rear)]**.

[Subwoofer Delay]

Adjusts the delay time of subwoofer sound.

- To close and finish the parameter setting, touch **[Close]**.

3 Touch [Gain] (①), and then adjust the sound level of each speaker (②).

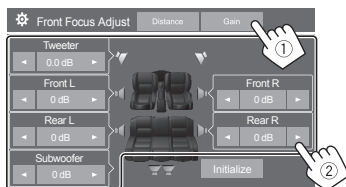

To initialize the setting value: Touch **[Initialize]**.

<Volume Offset>

Adjust and store the auto-adjustment volume level for each source.

The volume level will automatically increase or decrease when you change the source.

- 5 to +5 (Initial: 0)

Display settings

1 Display the <Display> screen.

On the source/option selection screen (page 12):



Then, on the <Setup> screen, touch as follows:

[Display] (①) → **[Enter]** for the item you adjust or the appropriate setting for the item (②).

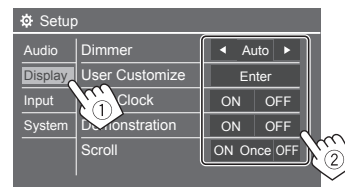

2 Adjust the item if more steps are required.

See the respective explanation that follows.

<Dimmer>

- Auto** (Initial): Dims the screen and button illumination when you turn on the headlights.
 - The ILLUMI lead connection is required (page 59).
- ON**: Activates dimmer.
- OFF**: Deactivates dimmer.

Settings

<User Customize>

You can change the following items.

- Background image of the Home screen
- Display background by using your desired still image file (JPEG/24 bit BMP/PNG)
- Illumination color of the buttons on the monitor panel
- Home screen display pattern

<Background>: Changes the background image of the Home screen.

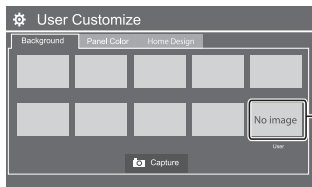

To store your own image into <User>.

<Panel Color>: Changes the illumination color of the buttons on the monitor panel.

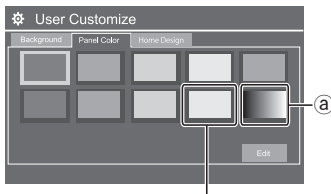

To store your own illumination color setting into the white-colored box.

- You can also adjust the illumination color yourself. Touch the white-colored box, and then [Edit] to display the illumination color adjustment screen, then select the dimmer setting and adjust the color. The adjustment is saved in the white-colored box.
- Selecting [a] changes the illumination color gradually.

<Home Design>: Changes the display pattern of the Home screen.

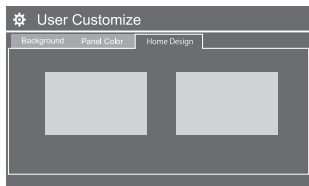

To store your own scene for <Background>

When using an image file, make sure that the resolution is 800 x 480 pixels.

- You cannot capture copyrighted content and images.
- The color of the captured image may look different from that of the actual scene.

1 While playing Slide Show, display the <User Customize> screen.

- ① Press the **HOME** button on the monitor panel. The Home screen is displayed.
- ② Touch [⏏], and then [⚙]. The <Setup> screen is displayed.
- ③ Then, on the <Setup> screen, touch as follows: [Display] → <User Customize>: [Enter]

2 Display the <Background> screen, and then touch [📷 Capture].

The current still picture is displayed on the screen.

[⏪] Moves to the following still picture.

3 Touch [📷 Capture] to capture the image.

A confirmation message appears. Touch [Yes] to store the captured image into [User]. (The existing image is replaced with the new one.)

- To return to the previous screen, touch [No].
- To cancel the capture, touch [Cancel].

<OSD Clock>

- **ON** (Initial): Displays the clock while the screen is off, or while a video source is playing.
- **OFF**: Cancels.

Settings

<Demonstration>

- **ON** (Initial): Activates the display demonstration.
- **OFF**: Deactivates the display demonstration.

<Scroll>

- **ON** (Initial): Scrolls the displayed information repeatedly.
- **Once**: Scrolls the displayed information once.
- **OFF**: Cancels.

Touching [**<**] scrolls the text regardless of this setting.

<Home Customize>

Changes the playback sources to display on the Home screen (page 3).

- 1 Select the source to replace (①), and then select a new source (②) to display on the Home screen.

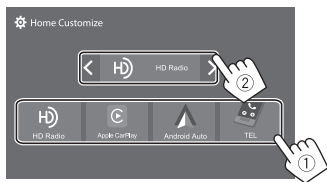

Eg. Home Customize screen for DMX809S

- 2 Repeat step 1 to replace the other playback sources.

<Screen Adjustment>

Adjust the following items related to the screen. Select [**DIM ON**] (dimmer on) or [**DIM OFF**] (dimmer off), then change the following settings:

<Contrast>

Adjusts the contrast.

- **-10** to **+10** (Initial: **0** for both dimmer on and off)

<Bright>

Adjusts brightness.

- **-15** to **+15** (Initial: **0** for dimmer on, and **+15** for dimmer off)

<Color>

Adjusts the color.

- **-10** to **+10** (Initial: **0** for both dimmer on and off)

<Tint>

Adjusts the tint.

- **-10** to **+10** (Initial: **0** for both dimmer on and off)

<Viewing Angle>

Select the viewing angle in relation to the monitor to make the image on the screen easier to see.

- **Under 0°** (Initial)/**5°/10°/15°/20°**

Input settings

- 1 Display the <Input> screen.

On the source/option selection screen (page 12):



Then, on the <Setup> screen, touch as follows:

[**Input**] (①) → [**Enter**] for the item you adjust or the appropriate setting for the item (②).

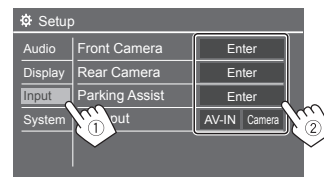

- 2 Adjust the item if more steps are required.

See the respective explanation that follows.

<Front Camera>

Configure the front view camera settings.

<Front Camera>

- **ON**: Select this when the front view camera is connected.
- **OFF** (Initial): Select this when no front view camera is connected.

Settings

<Front Camera Interruption>

When you shift the gear from the reverse position (R) to another position, the view screen changes to the front view screen automatically and remains for the preset period of time.

- Selectable when **<Front Camera>** and **<Rear Camera Interruption>** are set to **[ON]**.
- **5 Sec/10 Sec/15 Sec/20 Sec.**
- **OFF** (Initial): Not used.

<Rear Camera>

Configure the rear view camera settings.

<Rear Camera Interruption>



- **ON** (Initial): Displays the picture from the rear view camera when you shift the gear to the reverse (R) position.
 - A caution message appears on the screen. To remove the caution message, touch the screen.
- **OFF**: Select this when no rear view camera is connected.

<Parking Guidelines>

- **ON** (Initial): Displays the parking guidelines.
- **OFF**: Hides the parking guidelines.

<Guidelines Setup>

Adjust the parking guidelines according to the size of the car, parking space and so on.

When adjusting the parking guidelines, make sure to use the parking brake to prevent the car from moving. Select the  mark (1), and then adjust the position of the selected  mark (2).

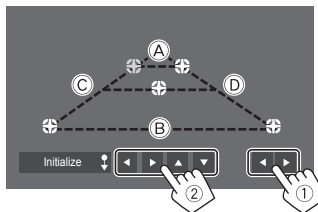

Make sure that **(A)** and **(B)** are horizontally parallel, and that **(C)** and **(D)** are the same length.

- Touch and hold **[Initialize ↓]** for 2 seconds to set all the marks to the initial default position.

<Reverse with ATT>

- **ON** (Initial): The sound is attenuated while the gear is shifted to the reverse (R) position.
- **OFF**: Not used.

<Parking Assist>

Configure settings for using the ADS adapter.

<Parking Assist Display>

When an ADS adapter is connected, you can display information about obstacles around the car.

- **ON**: Always displays information.
- **Dyn.** (Initial): Displays information when the sensor detects obstacles.
- **OFF**: Cancels.

<Parking Assist Position>

Select where information about obstacles is displayed on the screen.

- **Left/Right** (Initial)

<AV Input>

Select the usage of the AV-IN input terminal (adjustable only in Standby Mode (page 4)).

- **AV-IN** (Initial): Select this when an external AV device is connected.
 - To watch the connected device, select **[AV-IN]** on the source/option selection screen.
- **Camera**: Select this to watch the view from the connected camera.
 - To watch the camera view, select **[Camera]** on the source/option selection screen.

System settings

1 Display the <System> screen.

On the source/option selection screen (page 12):



Then, on the <Setup> screen, touch as follows:

[**System**] (①) → [**Enter**] for the item you adjust or the appropriate setting for the item (②).

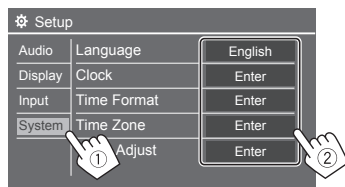

2 Adjust the item if more steps are required.

See the respective explanation that follows.

<Language>

Select the text language used for on-screen information. For details, see page 4.

“Please Ignition OFF” appears when the setting is changed. Turn the ignition switch off then on to enable the change.

<Clock>

Set the date and clock adjustment method. For details, see page 5.

<Time Format>

Select the time display format—either [12-Hour] (Initial) or [24-Hour].

<Time Zone>

Select the time zone for your residential area. For details, see page 5.

<Clock Adjust>

Adjust the date and clock manually. For details, see page 5.

<Daylight Saving Time>

(Not used when the clock is set manually)

Activate this by selecting the additional time for Daylight Saving Time (if available in your residential area). For details, see page 5.

<Connections SETUP>

Specify or confirm the connected devices information.

<Device List>

Shows the list of the connected (registered) devices. For details, see page 9.

<PIN Code>

Shows the current PIN code for this unit.

- This setting is available only when iPhone with Apple CarPlay is not connected.

<Device Name>

Shows the device name of this unit—**DMX809S** or **DMX8709S**.

<Bluetooth Device Address>

Shows the Bluetooth device address of this unit.

<Initialize>

Touch and hold [**Enter**] to reset all settings you have made for using Bluetooth mobile phones and Bluetooth audio players.

<TEL SETUP>

Configure settings for using Bluetooth mobile phones. For details, see page 39.

- This setting is available only when iPhone with Apple CarPlay is not connected.

<Wi-Fi Setup>

Shows the device name, device address and password of this unit.

<Device Audio Control>

Adjust the device sounds. For details, see page 11.

<Driving Position>

Set your driver's seat position of your car — [**LEFT**] (initial) or [**RIGHT**].

This setting changes the sidebar/button position of Apple CarPlay/Android Auto screens accordingly with the driver seat position.

- This setting is available only when iPhone with Apple CarPlay and Android device with Android Auto are not connected.

<Android Mode Select>

Select your Android usage — either [**Android Auto**] (initial) or [**Mirroring for Android**].

- This setting is available only in Standby Mode with no device connected via USB.

Settings

<Reset Android Auto Wireless Connection>

Reset the password of Android Auto wireless connection. For details, see page 11.

<Beep>

This setting is available only when 2-way speaker system is selected (page 43).

- **ON** (Initial): Activates the key-touch tone.
- **OFF**: Deactivates the key-touch tone.

<SETUP Memory>

Memorize, recall, or clear the settings you have made.

- The memorized settings are kept even when the unit is reset.
- Available only when <SETUP Memory> is set to **[Unlock]** (selected initially).

Touch **[Yes]** to display the setting screen, then select an operation:

- **Recall**: Recalls the memorized settings.
- **Memory**: Memorizes the current settings.
- **Clear**: Clears the currently memorized settings and return to the factory (initial) settings.
- **Cancel**: Cancels.

A confirmation message appears. Touch **[Yes]**.

You can also set to lock the <SETUP Memory> from being changed. Touch **[Lock]** to lock the settings.

- Some items in <Setup> menu, eg. <Speaker/X'over>, cannot be adjusted when **[Lock]** is selected.

<Wireless/HDMI SETUP>

Selection for wireless Apple CarPlay/Android Auto or HDMI device.

- **HDMI**: Select this to use the connected HDMI device. Wireless connected Apple CarPlay and Android Auto will be disconnected.
- **Wi-Fi** (initial): Select this to use wireless Apple CarPlay/Android Auto. The system of this unit is rebooted after touching **[OK]**.

<OEM Setup>

Get information, and change the settings for using the ADS adapter.

<Initialize>

Initialize all settings you have made. Touch and hold **[Enter]** to initialize the settings.

- After initializing the settings, adjust the settings on the <Initial Setup> screen.

<Serial Number>

Displays the serial number.

<System Information>

Update the system by connecting a USB device containing an update file.

- To obtain the update file, visit <<https://www.kenwood.com/cs/ce/>>.

Connect a USB device with the update file to the unit.

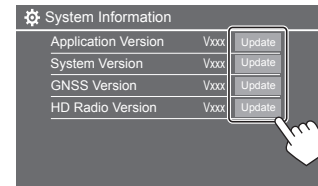

Update starts. It may take a while. If the update has been completed successfully, "Update Completed. Please Ignition OFF" appears.

<Application Version>

Updates the system application.

<System Version>

Updates the system.

<GNSS Version>

Updates the Global Navigation Satellite firmware.

<HD Radio Version> (Only for DMX809S)

Updates the HD Radio firmware.

- Do not disconnect the USB device while updating.
- If the update has failed, turn the ignition switch off then on, and retry the update.

<Open Source Licenses>

Shows the Open Source Licenses.

Remote Controller

To use the remote controller, purchase optional remote controller, KCA-RCDV340.

- When using the remote controller, refer also to the instruction manual supplied with the remote controller.

Remote sensor*

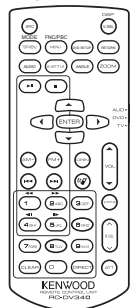

* DO NOT expose the remote sensor to bright light (direct sunlight or artificial lighting).

KCA-RCDV340

CAUTION

- Do not leave the remote controller in hot places such as on the dashboard.
- Risk of the fire of explosion if the battery is replaced by an incorrect type. Ensure to replace only with the same type.
- Risk of fire, explosion or the leakage of flammable liquid or gas if the battery is left in an extremely high temperature surrounding environment and/or subjected extremely low air pressure. The battery pack or batteries shall not be exposed to excessive heat such as sunshine, fire or the like
- Risk of fire, explosion or the leakage of flammable liquid or gas if the battery is disposed into fire or a hot oven, recharged, shorted, mechanically crushed or cut of the battery.
- If spilled fluid comes in contact with your eyes or on clothing, immediately rinse with water and consult a physician.

Preparation

Battery installation

Use two "AAA"/"R03"-size batteries.

Insert the batteries with the + and - poles aligned properly, following the illustration inside the case.

- Always insert batteries from - poles to avoid bending the springs.

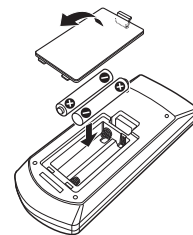

Remote Controller

- If the Remote Controller operates only over shorter distances or does not operate at all, it is possible that the batteries are depleted. In such instances, replace both batteries with new ones.

Remote Controller mode switch

The functions operated from the remote controller differ depending on the position of the mode switch.

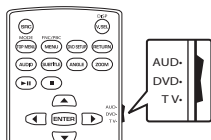

- AUD mode:** Switch to this mode when controlling a selected source or tuner source, etc.
- DVD mode:** Not used.
- TV mode:** Not used.

Basic operations for KCA-RCDV340

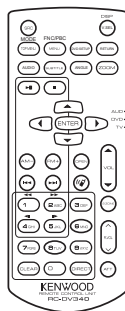

Common operations

SRC	<ul style="list-style-type: none"> Selects the source. Hangs up the incoming/current call.
VOL ▲/▼	Adjusts the volume level.
ATT	Attenuates/restores the sound.
☎	Answers incoming calls.
FNC/PBC/MENU	Switches the control screen of source.
MODE/ TOP MENU	Changes the aspect ratio. <ul style="list-style-type: none"> The aspect ratio changes each time you press this key.
V.SEL	Not used for this unit.

ENTER	Not used for this unit.
DVDSETUP	Not used for this unit.
RETURN	Not used for this unit.
AUDIO	Not used for this unit.
SUBTITLE	Not used for this unit.
ANGLE	Not used for this unit.
ZOOM	Not used for this unit.
OPEN	Not used for this unit.
2 ZONE	Not used for this unit.
R.VOL	Not used for this unit.
CLEAR	Not used for this unit.

Audio file/Video file/Picture file

FM+ / AM-	Selects a folder.
◀◀ / ▶▶	Selects a file.
▶▶	Starts/pauses playback.

HD Radio*1/Radio*2/SiriusXM

FM+ / AM-	Selects the band.
◀◀ / ▶▶	Searches for stations/channels.*3
▶▶	Switches the seek mode.

Remote Controller

- 0 – 9**
- Specifies preset number. **(1-5)**
 - Specifies the frequency of the station to receive to search for in direct search.

DIRECT Enters direct search mode.

- *1 Only for DMX809S.
- *2 Only for DMX8709S.
- *3 The search method differs according to the selected seek mode.

■ USB

FM+ / AM– Selects a folder.

◀◀ / ▶▶ Selects a file.

▶▶ Starts/pauses playback.

■ Searching for station frequency/channel number directly

While listening to the radio, you can search for a channel or station frequency directly using the number buttons.

1 Press DIRECT to enter the search mode.

2 Press a number button to select a desired item (channel or station frequency).

- To confirm the selection, press **◀◀ / ▶▶**.

To exit the search mode: Press **DIRECT**.

Installation and Connection

This section is for the professional installer. For safety's sake, leave wiring and mounting to professionals. Consult the car audio dealer.

⚠ WARNINGS

- DO NOT connect the ignition wire (red) and the battery wire (yellow) to the car chassis (ground), you may cause a short circuit, that in turn may start a fire.
- DO NOT cut out the fuse from the ignition wire (red) and the battery wire (yellow). The power supply must be connected to the wires via the fuse.
- Always connect the ignition wire (red) and the battery wire (yellow) to the power source running through the fuse box.

⚠ CAUTIONS

- Install this unit in the console of your car.
- Do not touch the metal parts of this unit during and shortly after the use of the unit. Metal parts such as the heat sink and enclosure become hot.
- When parking at a low ceiling area, turn off the unit to store the antenna. As when the unit is installed in the car with the function of auto antenna; the radio antenna extends automatically when you turn on the unit with the antenna control wire (ANT. CONT) connected (page 59).

Before installation

■ Precautions on installation and connection

- Mounting and wiring this product requires skills and experience. For best safety, leave the mounting and wiring work to professionals.
- Mount the unit so that the mounting angle is 30° or less.
- Make sure to ground the unit to a negative 12 V DC power supply.
- Do not install the unit in a location exposed to direct sunlight or excessive heat or humidity. Also avoid places with too much dust or the possibility of water splashing.
- Do not use your own screws. Use only the screws provided. If you use the wrong screws, you could damage the unit.
- After the unit is installed, check whether the brake lamps, blinkers, wipers, etc. on the car are working properly.
- Do not press hard on the panel surface when installing the unit to the car. Otherwise scratches, damage, or failure may result.
- If the power is not turned on ("Miswiring DC Offset Error", "Warning DC Offset Error" is displayed), the speaker wire may have a short circuit or have touched the chassis of the car and the protection function may have been activated. In this case, the speaker wire should be checked.
- Keep all cables away from heat dissipating metal parts.

Installation and Connection

- If your car's ignition does not have an ACC position, connect the ignition wires to a power source that can be turned on and off with the ignition key. If you connect the ignition wire to a power source with a constant voltage supply, such as with battery wires, the battery may be drained.
- If the fuse blows, first make sure the wires are not touching to cause a short circuit, then replace the old fuse with one with the same rating.
- Insulate unconnected wires with vinyl tape or other similar material. To prevent a short circuit, do not remove the caps and do not let the cable out at the ends of the unconnected wires or the terminals.
- Secure the wires with cable clamps and wrap vinyl tape around the wires that comes into contact with metal parts to protect the wires and to prevent short circuit.
- Connect the speaker wires correctly to the terminals to which they correspond. The unit may be damaged or fail to work if you share the ⊖ wires or ground them to any metal part in the car.
- When only two speakers are being connected to the system, connect both connectors either to the front output terminals or to the rear output terminals (do not mix front and rear). For example, if you connect the ⊕ connector of the left speaker to a front output terminal, do not connect the ⊖ connector to a rear output terminal.

Parts list for installation

Note: This parts list does not include all the package contents.

- 1 Wiring harness (× 1)
- 2 Extension wire, 2 m (× 1)
- 3 Flat head screws, M5 × 8 mm (× 6)
- 4 Round head screws, M5 × 8 mm (× 6)
- 5 Microphone, 3 m (× 1)
- 6 Trim plate (× 1)
- 7 Mounting sleeve (× 1)
- 8 Extraction keys (× 2)
- 9 GPS antenna, 3.5 m (× 1)
- 10 Metal plate (× 1)

Installation procedure

- 1 **Remove the key from the ignition and disconnect the ⊖ battery.**
- 2 **Make the proper input and output wire connections for each unit.**
- 3 **Connect the speaker wires of the wiring harness.**
- 4 **Connect the wires of the wiring harness in the following order: ground, battery, ignition.**
- 5 **Connect the wiring harness to the unit.**
- 6 **Install the unit in your car.**
Make sure that the unit is installed securely in place. If the unit is unstable, it may malfunction (eg, the sound may skip).
- 7 **Reconnect the ⊖ battery.**
- 8 **Initialize the unit (page 51).**
- 9 **Configure <Initial Setup> (page 4).**

Installation and Connection

Installing the unit

■ Installing the unit using the mounting bracket removed from the car

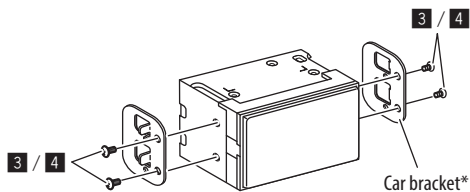

Note: Select the appropriate screws (supplied) for the mounting bracket.

* Shape of your car brackets may differ.

■ Installing the unit using the mounting sleeve

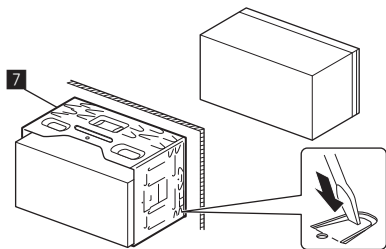

Bend the tabs of the mounting sleeve with a screwdriver or similar utensil and attach it in place.

■ Installing the trim plate

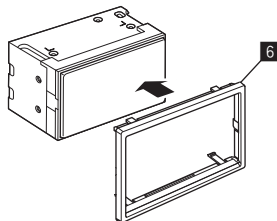

Removing the unit

1 Remove the trim plate (6) by inserting the two extraction keys (8) as illustrated.

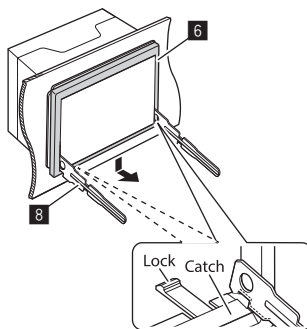

2 When the lower level is removed, remove from the upper two catches of the trim plate (6).

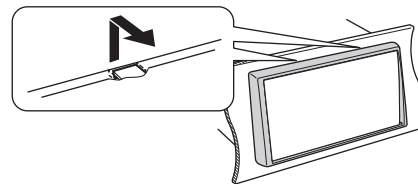

The frame can be removed from the top side in the same manner.

3 Insert the extraction keys (8) deeply into the slots on each side.

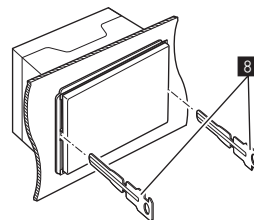

Installation and Connection

- Lower the extraction keys (8) toward the bottom, and pull out the unit halfway while pressing towards the inside.

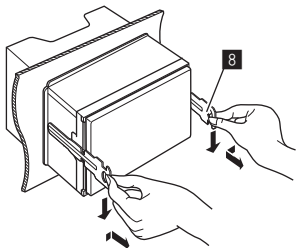

Be careful to avoid injury from the catch pins on the extraction key.

- Pull the unit all the way out with your hands, being careful not to drop it.

Installing the supplied GPS antenna

GPS antenna is installed inside of the car. It should be installed as horizontally as possible to allow easy reception of the GPS satellite signals.

- Clean your dashboard or other surface.
- Remove the separator of the metal plate (10).
- Press the metal plate (10) down firmly on your dashboard or other mounting surface.
You can bend the metal plate (10) to conform to a curved surface, if necessary.
- Remove the separator of the GPS antenna (9), and stick the antenna to the metal plate (10).

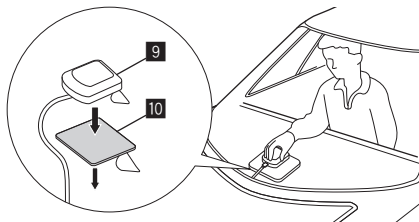

Notes on using the supplied GPS antenna (9)

- Use the supplied GPS antenna (9). Using the GPS antenna other than the supplied one may cause a drop in positioning accuracy.
- Depending on the type of car, reception of the GPS satellite signals might not be possible with an inside installation.
- Please install the supplied GPS antenna (9) in an area away from any antennas that are used with CB radios or satellite televisions.
- The supplied GPS antenna (9) should be installed at a position that is spaced at least 30 cm (12 inch) from cellular phone or other transmitting antenna. Signals from the GPS satellite may be interfered with by these types of communication.
- Painting the supplied GPS antenna (9) with (metallic) paint may cause a drop in performance.

Installation and Connection

Connecting external components

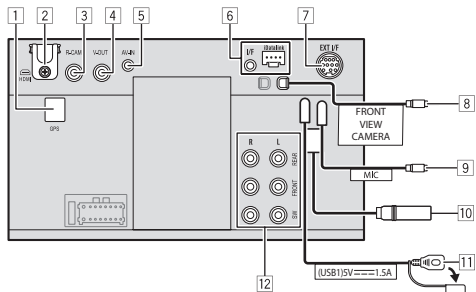

- 1 GPS antenna input (GPS) (page 57)
- 2 HDMI terminal
- 3 Rear view camera input (R-CAM)
- 4 Video output (V-OUT)
- 5 Audio video input (AV-IN)
- 6 iDataLink input for connecting an ADS adapter (commercially available)
- 7 Expansion port for connecting SiriusXM Connect Vehicle Tuner (EXT I/F) (commercially available)
- 8 Front view camera input
- 9 Microphone input (MIC) (page 59)
- 10 Antenna terminal
- 11 USB terminal
- 12 Output terminals*
 - Left output (White)
 - Right output (Red)

REAR: Rear speaker preouts
 FRONT: Front speaker preouts
 SW: Subwoofer preouts

For 3-way crossover:

REAR: Tweeter preouts
 FRONT: Mid range speaker preouts
 SW: Subwoofer preouts

* When connecting an external amplifier, connect its ground wire to the chassis of the car; otherwise the unit may be damaged.

- 2 Use HDMI cable KCA-HD200 (optional accessory).



W: 11.1 mm or less
 H: 7.7 mm or less
 D: 21.5 mm or less

When you connect the cable to HDMI terminal, detach the fixture. After connecting the cable, attach the fixture back using the screw.

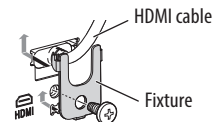

- 5 Connect the following type of 4-pole mini plug:

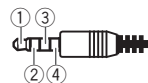

- 1 Left audio
- 2 Right audio
- 3 Ground
- 4 Composite video

- 7

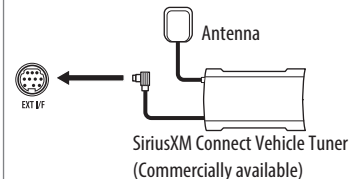

Installation and Connection

Wiring connection

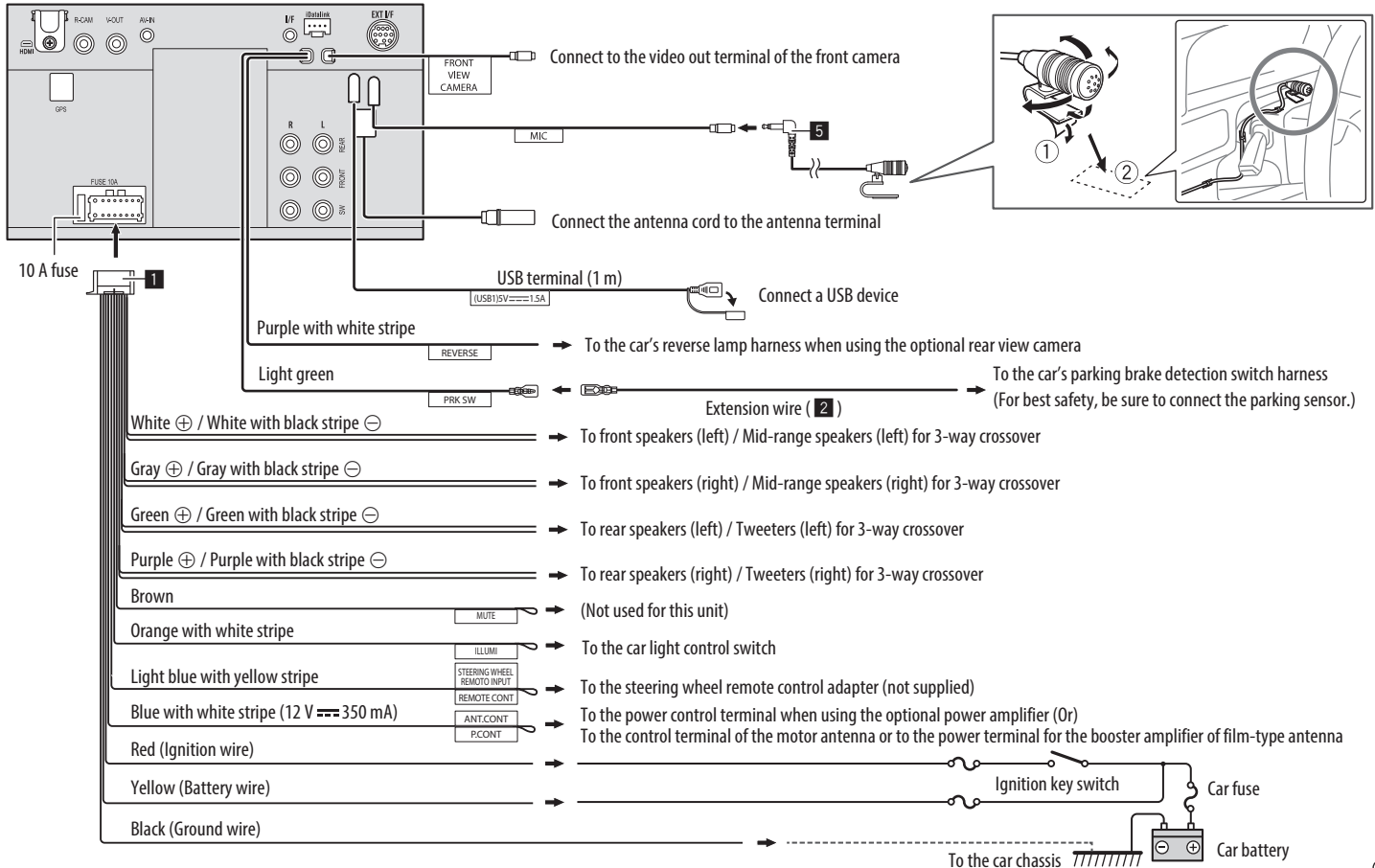

References

Maintenance

Cleaning the unit

- Do not use any solvent (for example, thinner, benzene, etc.), detergent, or insecticide. This may damage the monitor or the unit.
- Gently wipe the panel with a soft, dry cloth.

More information

About USB playback

Important

Make sure all important data has been backed up to avoid losing the data. We bear no responsibility for any loss of data stored in the devices while using this unit.

Notes on using a USB device

- Avoid using the USB device if it might affect driving safety.
- When connecting with a USB cable, use a USB 2.0 cable.
- Electrostatic shock at connecting a USB device may cause abnormal playback of the device. In this case, disconnect the USB device, and turn off then on this unit.
- Do not pull out and connect the USB device repeatedly while "Reading" is shown on the screen.
- Operation and power supply may not work as intended for some USB devices.
- Do not leave a USB device in the car, or expose to direct sunlight or high temperatures to prevent deformation or damage to the device.

Playable files

- This unit can play back the following files with following codec and extension code:
 - **Audio files:** MP3 (.mp3), WMA (.wma), WAV (.wav), AAC (.m4a), FLAC (.flac)
 - **Picture files:** JPEG (.jpg, .jpeg)/PNG (.png)/24 bit BMP (.bmp)
 - **Video files:** MPEG1, 2 (.mpg, .mpeg)/MPEG4 (.mp4)/H.264 (.h264)/MWM (.mwm)/MKV (.mkv)

Audio file conditions

- This unit can play back files that meet the conditions below:
 - Bit rate:
 - MP3: MPEG1 Audio Layer 3: 32 kbps – 448 kbps
 - MPEG2 Audio LSF Layer: 32 kbps – 384 kbps
 - WMA: Up to 320 kbps
 - AAC: Max 288 kbps per channel/48 kHz
 - Bit number:
 - WAV: 4 bits – 32 bits
 - FLAC: 4 bits – 32 bits
 - Sampling frequency:
 - MP3: MPEG1 Audio Layer 3: 32 kHz – 48 kHz
 - MPEG2 Audio LSF Layer: 16 kHz – 24 kHz
 - WMA: 8 kHz – 48 kHz
 - AAC: 8 kHz – 96 kHz
 - WAV: 44.1 kHz – 192 kHz
 - FLAC: 8 kHz – 192 kHz
 - Files recorded in VBR (variable bit rate), and have a discrepancy in elapsed time indication.

- This unit can show or display the following Tag:
 - MP3: ID3 Tag (version 1.0/1.1/2.2/2.3/2.4)
 - WMA Tag
 - WAV Tag
 - AAC Tag
 - FLAC Tag
 - Jacket picture (artwork):
 - Data size: less than 500 KB
- This unit cannot play back the following files:
 - MP3 files encoded with MP3i and MP3 PRO format.
 - MP3 files encoded with Layer 1/2.
 - WMA files encoded with lossless, professional, and voice format.
 - WMA files which are not based upon Windows Media® Audio.
 - WMA/AAC files copy-protected with DRM

References

Video file conditions

- Streams that conform to:
 - MPEG1/MPEG2:
Audio: MP1, MP2, MP3, AAC-LC, AC3, LPCM
Video: MPEG1, MPEG2
 - MPEG4:
Audio: MP3, AAC
Video: MPEG4
 - H.264:
Audio: MP3, AAC
Video: H.264
 - MKV:
Audio: MP3, AC3, LPCM, AAC-LC/HE, AAC, Cook
Video: H.264, MPEG-4 AVC, MPEG4, WMV
 - WMV:
Audio: WMA
Video: Windows Media Video 9
- Maximum bit rate:
 - MPEG1: Max 4 Mbps
 - MPEG4/H.264/WMV: Max 8 Mbps
- Picture size
 - MPEG1: 176 x 144 , 352 x 240 , 720 x 480 (30fps)
 - MPEG2: 176 x 144, 352 x 288, 320 x 240, 720 x 480, 720 x 576, 1 440 x 1 080, 1 280 x 720, 1 920 x 1 080
 - H.264: 1 920 x 1 080 (30fps)
 - WMV: 1 280 x 720 (60fps), 1 920 x 1 080 (30fps)
 - MPEG4: 1 920 x 1 080 (30fps)

- Other playable conditions:
 - Video file size: Less than 2 GB
 - MPEG1/MPEG2: File format: SP@LL, SP@ML, MP@LL, MP@ML, MP@H-14 , MP@HL, HP@LL, HP@ML, HP@H-14, HP@HL

Folder/file limitations

This unit can recognize:

- A total of 5 000 files
- 250 folders each for video files/photo files and a maximum of 999 files per folder
- The maximum number of characters is 260 characters for folder name plus file name (when the characters are 1 byte).

Unplayable USB device

- This unit may not play back files in a USB device properly when using a USB extension cable.
- USB devices equipped with special functions such as data security functions cannot be used with the unit.
- Do not use a USB device with nine or more partitions.
- Depending on the shape of the USB devices and connection ports, some USB devices may not be attached properly or the connection might be loose.
- This unit may not recognize a memory card inserted into a USB card reader.

About Apple CarPlay

- The following iPhone devices can be used.
Made for
 - iPhone 6S, 6S Plus, 7, 7 Plus, 8, 8 Plus, X, XS, XS Max, XR, 11, 11 Pro, 11 Pro Max, SE (1st/2nd generation), 12, 12 mini, 12 Pro, 12 Pro Max, 13, 13 mini, 13 Pro, 13 Pro Max
- The GPS antenna must be connected to use Apple CarPlay wirelessly with Wi-Fi.
- Although the service area is expanding, Apple CarPlay service is NOT available in some markets. Please check the latest information concerning availability in your region from the below website.
 - <http://www.apple.com/ios/feature-availability/#applecarplay-applecarplay>

About Android Auto

- Although the service area is expanding, Android Auto service is NOT available in some markets. Please check the latest information concerning availability in your region from the below website.
 - <https://support.google.com/androidauto/>

■ About USB Mirroring

- Depending on the connected Android device, you may need to enable virtual keyboard setting on your smartphone to display software keyboard on the screen of this unit and on your Android device.
- The audio may be of poor quality, interrupted or skipped, depending on several conditions such as network condition, the application and etc.
- If you perform pairing with another device during mirroring, mirroring (audio and/or video) will be disturbed or paused.
- Some Apps may not support audio sharing (no sound from the background playback source).
- Some operations may not work depending on the compatibility between this unit, Mirroring OA for KENWOOD App and your Android device.

Troubleshooting

What appears to be trouble is not always serious. Check the following points before calling a service center.

- For operations with external components, refer also to the instructions supplied with the adapters used for connection (as well as the instructions supplied with the external components).

General

No sound comes out of the speakers.

- Adjust the volume to the optimum level.
- Check the cords and connections.

No picture is displayed on the screen.

- Turn on the screen (page 4).

The unit does not work at all.

- Initialize the unit (page 51).

The remote controller does not work.

- Replace the battery.

“No Signal”/“No Video Signal” appears.

- Start playback on the external component connected to this unit.
- Check the cords and connections.
- Signal input is too weak.

“Miswiring DC Offset Error”/“Warning DC Offset Error” appears.

- A speaker cord has shorted or it has come into contact with the car chassis. Wire or insulate the speaker cord as appropriate, turn the ignition switch off then on.

“Parking off” appears.

- No playback picture is shown when the parking brake is not engaged.

Bluetooth connection

The Bluetooth device does not detect this unit.

- Turn off, then turn on the Bluetooth device.
- Turn off, then turn on this unit.

This unit does not pair with the Bluetooth device.

- If the device is connected via USB cable, disconnect it, and retry.
- Turn off, then turn on the Bluetooth device.

The device is disconnected automatically or the device cannot be connected.

- When iPhone compatible with Apple CarPlay is connected to the USB terminal, it cannot be connected via Bluetooth. Use the phone and audio player function on the Apple CarPlay screen.
- When an Android device compatible with Android Auto is connected to the USB terminal, the device is connected via Bluetooth automatically, and the Bluetooth mobile phone currently connected is disconnected.

Troubleshooting

The Bluetooth connection between the Bluetooth device and the unit is unstable.

- Delete the unused registered Bluetooth device from the unit (page 10).

“Connection Error” appears.

- The device is registered but the connection has failed. Connect the registered device using the <Device List> screen (page 9).

“Please Wait...” appears.

- The unit is preparing to use the Bluetooth function. If the message does not disappear, turn off and turn on the unit, then connect the device again.

“Initialize Error” appears.

- The unit has failed to initialize the Bluetooth module. Try the operation again.

Wi-Fi connection

iPhone for Apple CarPlay or Android device for Android Auto cannot be connected wirelessly, but the confirmation screen appears.

- When the HDMI is activated, Wi-Fi cannot be used. To use Wi-Fi, touch [SETUP] on the confirmation screen (the <Wireless/HDMI SETUP> screen is displayed), and then activate Wi-Fi (page 51).

Apps

Apple CarPlay:

[Apple CarPlay] is not highlighted on the source/option selection screen.

- Check the version of the connected iPhone—whether it is compatible with Apple CarPlay.
- Check the iPhone is connected properly for Apple CarPlay. You can check the connection referring to the <Device List> screen.

Sound is too loud or small while using Apple CarPlay.

- Adjust <Guidance/Voice Recognition Volume>, <Phone Incoming Volume>, <Phone Calling/Talking Volume> or <Media Volume> for <Apple CarPlay> (page 12).

The Home screen appears while using Apple CarPlay.

- Wi-Fi is disconnected.

Android Auto:

[Android Auto] is not highlighted on the source/option selection screen.

- Check whether [Android Auto] is selected in the <Android Mode Select> (page 50).
- Check the version of the connected Android device—whether it is compatible with Android Auto.
- Check the Android device is connected properly for Android Auto. You can check the connection referring to the <Device List> screen.

The Home screen appears while using Android Auto.

- Wi-Fi is disconnected.

Sound is too loud or small while using Android Auto.

- Adjust <Guidance/Voice Recognition Volume>, <Phone Incoming Volume>, <Phone Calling/Talking Volume> or <Media Volume> for <Android Auto> (page 12).

Android Auto is deactivated.

- When you start Apple CarPlay, Android Auto is deactivated.

USB Mirroring:

[USB Mirroring] is not highlighted on the source/option selection screen.

- Check whether [Mirroring for Android] is selected in the <Android Mode Select> (page 50).
- Check the version of the connected Android device—whether it is compatible with USB Mirroring.
- Check the Android device is connected properly for USB Mirroring. You can check the connection referring to the <Device List> screen.
- Check KENWOOD's Mirroring OA App is activated on Android device.

USB Mirroring is deactivated.

- When you start Apple CarPlay, USB Mirroring is deactivated.

No sounds from Android device come out of the speakers.

- Check the Android device is connected properly with Bluetooth.

Troubleshooting

USB

“No File” appears.

- The loaded USB does not contain any file of the selected type (audio/video/photo). Select the correct file type or replace the USB.

“Reading” does not disappear from the screen.

- Turn the power off and on again.

While playing a file, sound is sometimes interrupted.

- The tracks are not properly copied into the USB device. Copy the files again, and try again.

Files are not played back as you have intended them to play.

- Playback order may differ from the one played back using other players.

The source does not change to [USB] when you connect a USB device while listening to another source or “USB Device Error” appears when you connect a USB device.

- The USB port is drawing more power than the design limit.
- Turn the power off and unplug the USB device. Then, turn on the power and reattach the USB device.
- If the above does not solve the problem, turn the power off and on before replacing with another USB device.

HD Radio (for DMX809S)

Sound quality changes when receiving HD Radio stations.

- Fix the **<Receive Mode>** setting either **[Digital]** or **[Analog]** (page 23).

No sound can be heard.

- The **<Receive Mode>** setting is not appropriate. Select the appropriate mode – **[Digital]**, **[Analog]**, or **[Auto]** (page 23).

Radio (for DMX8709S)

AME automatic presetting does not work.

- Store stations manually (page 26).

Static noise while listening to the radio.

- Connect the antenna firmly.

HDMI

HDMI device connected to the HDMI terminal cannot be used.

This is normal when **[Wi-Fi]** is selected for the **<Wireless/HDMI SETUP>** setting (page 51). Select **[HDMI]** to use the HDMI device.

No picture appears on the screen.

- While driving, no video is shown. You can only listen to the sounds.
- Turn on the HDMI device if it is not on.
- Connect the HDMI device correctly.

AV-IN

No picture appears on the screen.

- While driving, no video is shown. You can only listen to the sounds.
- Select **[AV-IN]** for **<AV Input>** setting (page 49).
- Turn on the external component if it is not on.
- Connect the external component correctly.

Cameras

No picture appears on the screen.

- Connect the camera correctly.

Picture from the camera connected to the AV-IN terminal is not displayed on the screen.

- Select **[Camera]** for **<AV Input>** setting (page 49).

SiriusXM Satellite Radio

“SXM No Signal” appears.

- Make sure the antenna of the SiriusXM Connect Vehicle Tuner is mounted outside the car. Move the car to an area with a clear view of the sky.

“SXM Check Antenna” appears.

- Check the antenna connection of the SiriusXM Connect Vehicle Tuner, and make sure the antenna is firmly attached to the tuner.
- Check whether the antenna cable of the SiriusXM Connect Vehicle Tuner is bent or broken. If it is damaged, replace the whole antenna unit.

Troubleshooting

“SXM Check Tuner” appears.

- Make sure the SiriusXM Connect Vehicle Tuner is connected to the unit.

“SXM Chan Unavailable” appears.

(Appears on the screen for about 5 seconds, then returns to the previous channel):

- The selected channel is no longer available. Select another channel or continue listening to the previous channel.

“SXM Ch Unsubscribed” appears.

(Appears on the screen for about 5 seconds, then returns to the previous channel)

- The selected channel is not part of your current subscription plan. Call 1-866-635-2349 (USA) or 1-888-539-7474 (Canada) to subscribe.

“SXM Subscription Updated – Press Return to Continue” appears.

- Your subscription has been updated. Press the appropriate button to continue.

“SXM Channel Locked” appears.

- The selected channel has been locked by the parental controls. Enter the parental lock code when you are asked.

“SXM Incorrect Lock Code” appears.

- You have entered an incorrect lock code. Enter the correct parental lock code.

Bluetooth hands-free phone

Phone is disconnected.

- When iPhone for Apple CarPlay or Android Auto device is connected, the currently connected Bluetooth device is disconnected. Use Apple CarPlay or Android Auto screen for phone.

Phone sound quality is poor. Echo or noise occurs.

- Reduce the distance between the unit and the Bluetooth mobile phone.
- Move the car to a place where you can get a better signal reception.
- Adjust the sound quality using <Microphone Level>, <Echo Cancel Level>, <Noise Reduction Level> (page 12).

The unit does not respond when you try to copy the phone book to the unit.

- You may have tried to copy the same entries (as stored) to the unit.

“No Data” appears.

- No phone book data is contained in the connected Bluetooth phone.

“Dial Error” appears.

- Dialing has failed. Try the operation again.

“Hung Up Error” appears.

- The call has not ended yet. Park your car, and use the connected mobile phone to end the call.

“Pick Up Error” appears.

- The unit has failed to receive a call.

Bluetooth audio

Bluetooth audio played is disconnected.

- When iPhone for Apple CarPlay or Android Auto device is connected, the currently connected Bluetooth device is disconnected.

The sound is interrupted or skipped while using a Bluetooth audio player.

- Reduce the distance between the unit and the Bluetooth audio player. Disconnect the device connected for Bluetooth phone if any.
- Turn off, then turn on the unit. (When the sound is not yet restored) connect the player again.

The connected audio player cannot be controlled.

- Check whether the connected audio player supports AVRCP (Audio/Video Remote Control Profile).

Specifications

■ Monitor section

Picture Size (W × H)	6.75 inches (diagonal) wide 151.8 mm × 79.7 mm (6" × 3-1/7")
Display System	TN LCD panel
Drive System	TFT active matrix system
Number of Pixels	1 152 000 (800H × 480V × RGB)
Effective Pixels	99.99%
Pixel Arrangement	RGB striped arrangement
Back Lighting	LED

■ USB I/F section

Connector Type	Type-A
USB Standard	USB 2.0 Full Speed/High Speed
File System	FAT 16/32, exFAT
Maximum Power	DC 5 V  1.5 A
Supply Current	
D/A Converter	24 bit
Audio Decoder	MP3/WMA/AAC/WAV/FLAC
Video Decoder	MPEG1/MPEG2/MPEG4/ WMV/H.264/MKV
Frequency Response	192 kHz Sampling: 20 Hz to 20 000 Hz 96 kHz Sampling: 20 Hz to 20 000 Hz 48 kHz Sampling: 20 Hz to 20 000 Hz 44.1 kHz Sampling: 20 Hz to 20 000 Hz
Total Harmonic Distortion	0.010% (1 kHz)
Signal to Noise Ratio	98.5 dB
Dynamic Range	89 dB

■ Bluetooth section

Technology	Bluetooth V5.0
Frequency	2.402 GHz to 2.480 GHz
Maximum Communication Range	Line of sight approx. 10 m (32.8 ft)
Audio Codec	SBC/AAC
Multi Profile Support	Multi Profile
Profile	HFP (Hands Free Profile) V1.8 SPP (Serial Port Profile) A2DP (Advanced Audio Distribution Profile) V1.3.2 AVRCP (Audio/Video Remote Control Profile) V1.6.2 PBAP (PhoneBook Access Profile)

■ Wi-Fi section

IEEE Standard	802.11 a/b/g/n/ac
Frequency Range	Dual Band (2.4 GHz/5 GHz)
Channels	Auto (1-11ch) Auto (149,153,155,157,161ch)
Transfer rates (MAX)	11a: 54 Mbps / 11b: 11 Mbps / 11g: 54 Mbps / 11n: 150 Mbps / 11ac: 433 Mbps

Specifications

DSP section

Equalizer Band	13 Band Frequency (Hz): 62.5/100/160/250/400/630/ 1k/1.6k/2.5k/4k/6.3k/10k/ 16k Gain (dB): -9/-8/-7/-6/-5/-4/-3/-2/ -1/0/1/2/3/4/5/6/7/8/9
Tweeter:	Gain (dB): -8/-7/-6/-5/-4/-3/-2/-1/0
HPF:	Frequency (Hz): Through/30/40/50/60/70/ 80/90/100/120/150/180/ 220/250 Slope (dB/Oct.): -6/-12/-18/-24 Gain (dB): -8/-7/-6/-5/-4/-3/-2/-1/0
LPF:	Frequency (Hz): 30/40/50/60/70/80/90/100/ 120/150/180/220/250/ Through Slope (dB/Oct.): -6/-12/-18/-24 Gain (dB): -8/-7/-6/-5/-4/-3/-2/-1/0 Phase: Normal/Reverse

Tweeter HPF:	Frequency (Hz): 1k/1.6k/2.5k/4k/5k/6.3k/8k/ 10k/12.5k Slope (dB/Oct.): -6/-12 Gain (dB): -8/-7/-6/-5/-4/-3/-2/-1/0 Phase: Normal/Reverse
--------------	---

Mid Range HPF:	Frequency (Hz): Through/30/40/50/60/70/ 80/90/100/120/150/180/ 220/250 Slope (dB/Oct.): -6/-12
----------------	---

Mid Range LPF:	Frequency (Hz): 1k/1.6k/2.5k/4k/5k/6.3k/8k/ 10k/12.5k/Through Slope (dB/Oct.): -6/-12 Gain (dB): -8/-7/-6/-5/-4/-3/-2/-1/0 Phase: Normal/Reverse
----------------	---

Subwoofer LPF:	Frequency (Hz): 30/40/50/60/70/80/90/100/ 120/150/180/220/250/ Through Slope (dB/Oct.): -6/-12 Gain (dB): -8/-7/-6/-5/-4/-3/-2/-1/0 Phase: Normal/Reverse
----------------	---

Digital FM radio section (for DMX809S)

Frequency Range (Frequency Step)	87.9 MHz to 107.9 MHz (200 kHz)
Frequency Response (±3.0 dB)	20 Hz to 20 kHz
Signal to Noise Ratio	75 dB (STEREO)

FM radio section

Frequency Range (Frequency Step)	87.9 MHz to 107.9 MHz (200 kHz)
Usable Sensitivity (S/N: 30 dB)	7.2 dBf (0.63 μV/75 Ω)
Quieting Sensitivity (DIN S/N: 46 dB)	15.2 dBf (1.58 μV/75 Ω)
Frequency Response (±3.0 dB)	30 Hz to 15 kHz
Signal to Noise Ratio	68 dB (MONO)
Selectivity (±400 kHz)	> 80 dB
Stereo Separation	40 dB (1 kHz)

Digital AM radio section (for DMX809S)

Frequency Range (Frequency Step)	530 kHz to 1 700 kHz (10 kHz)
Frequency Response (±3.0 dB)	40 Hz to 15 kHz
Signal to Noise Ratio	70 dB (STEREO)

Specifications

AM radio section

Frequency Range (Frequency Step)	530 kHz to 1 700 kHz (10 kHz)
Usable Sensitivity	29 dBμ (28.2 μV)

Video section

Color System of External Video Input	NTSC/PAL
External Video Input Level (RCA jack)/ (mini jack)	1 Vp-p/75 Ω 1 Vp-p/75 Ω
External Audio Max Input Level (mini jack)	2 V/25 kΩ
Video Input Level (RCA jack)	1 Vp-p/75 Ω
Video Output Level (RCA jack)	1 Vp-p/75 Ω

Audio section

Maximum Power Output (Front & Rear)	50 W × 4
Typical Power Output (Front & Rear)	Full Bandwidth Power (at less than 1% THD) 22 W × 4
Output Frequency Band	20 Hz to 88 000 Hz
Preout Level	DMX809S: 5V/10 kΩ DMX8709S: 4V/10 kΩ
Preout Impedance	≤ 600 Ω
Speaker Impedance	4 Ω to 8 Ω

HDMI I/F section

Connector Type	Type-D
Input Resolution	VGA (640 × 480p @ 59.94 Hz/60 Hz) 480p (720 × 480p @ 59.94 Hz/60 Hz)
Input Audio Type	32 kHz/44.1 kHz/48 kHz/ 88.2 kHz/96 kHz/176.2 kHz/ 192 kHz 16 bit/20 bit/24 bit Linear PCM

General

Operating Voltage	12 V DC car battery
Installation	Main unit:
Dimensions (W × H × D)	180 mm × 100 mm × 75 mm (7-1/16" × 3-15/16" × 2-15/16") With sleeve: 182 mm × 111 mm × 74 mm (7-3/16" × 4-3/8" × 2-15/16")
Weight (Main Unit)	1.2 kg (2.7 lbs) (including trim plate and sleeve)

Design and specifications are subject to change without notice.

Trademarks and Licenses

- Windows Media is a registered trademark or trademark of Microsoft Corporation in the United States and/or other countries. This product is protected by certain intellectual property rights of Microsoft. Use or distribution of such technology outside of this product is prohibited without a license from Microsoft.
- Use of the Made for Apple badge means that an accessory has been designed to connect specifically to the Apple product(s) identified in the badge and has been certified by the developer to meet Apple performance standards. Apple is not responsible for the operation of this device or its compliance with safety and regulatory standards. Please note that the use of this accessory with an Apple product may affect wireless performance.
- Apple, iPhone, and Lightning are trademarks of Apple Inc., registered in the U.S. and other countries.
- Apple, Siri, Apple CarPlay and Apple CarPlay logo are trademarks of Apple Inc., registered in the U.S. and other countries.
- App Store is a service mark of Apple Inc., registered in the U.S. and other countries.
- IOS is a trademark or registered trademark of Cisco in the U.S. and other countries and is used under license.
- Google, Android, Android Auto, Google Maps and other marks are trademarks of Google LLC.
- To use Android Auto on your car display, you'll need an Android Auto compatible vehicle or aftermarket stereo, an Android phone running Android 6.0 or higher, an active data plan, and the Android Auto app.

Trademarks and Licenses

- Wi-Fi® is a registered trademark of Wi-Fi Alliance®.
- The Wi-Fi CERTIFIED™ Logo is a registered trademark of Wi-Fi Alliance®.
- The Bluetooth® word mark and logos are registered trademarks owned by Bluetooth SIG, Inc. and any use of such marks by JVCKENWOOD Corporation is under license. Other trademarks and trade names are those of their respective owners.
- SiriusXM and all related marks and logos are trademarks of Sirius XM Radio, Inc. All rights reserved.
- HD Radio Technology manufactured under license from iBiquity Digital Corporation. U.S. and Foreign Patents. For patents see <http://dts.com/patents>. HD Radio™ and the HD, HD Radio, and “ARC” logos are registered trademarks or trademarks of iBiquity Digital Corporation in the United States and/or other countries.
- The terms HDMI, HDMI High-Definition Multimedia Interface, and the HDMI Logo are trademarks or registered trademarks of HDMI Licensing Administrator, Inc.
- Font for the this product is RT Font designed and sold by Ricoh Industrial Solutions Inc.
- Linux® is the registered trademark of Linus Torvalds in the U.S. and other countries.
- THIS PRODUCT IS LICENSED UNDER THE AVC PATENT PORTFOLIO LICENSE FOR THE PERSONAL USE OF A CONSUMER OR OTHER USES IN WHICH IT DOES NOT RECEIVE REMUNERATION TO
(i) ENCODE VIDEO IN COMPLIANCE WITH THE AVC STANDARD (“AVC VIDEO”) AND/OR (ii) DECODE AVC VIDEO THAT WAS ENCODED BY A CONSUMER ENGAGED IN A PERSONAL ACTIVITY AND/OR WAS OBTAINED FROM A VIDEO PROVIDER LICENSED TO

PROVIDE AVC VIDEO. NO LICENSE IS GRANTED OR SHALL BE IMPLIED FOR ANY OTHER USE. ADDITIONAL INFORMATION MAY BE OBTAINED FROM MPEG LA, L.L.C. SEE [HTTP://WWW.MPEGLA.COM](http://WWW.MPEGLA.COM)

- THIS PRODUCT IS LICENSED UNDER THE MPEG-4 VISUAL PATENT PORTFOLIO LICENSE FOR THE PERSONAL AND NON-COMMERCIAL USE OF A CONSUMER FOR
(j) ENCODING VIDEO IN COMPLIANCE WITH THE MPEG-4 VISUAL STANDARD (“MPEG-4 VIDEO”) AND/OR (jj) DECODING MPEG-4 VIDEO THAT WAS ENCODED BY A CONSUMER ENGAGED IN A PERSONAL AND NON-COMMERCIAL ACTIVITY AND/OR WAS OBTAINED FROM A VIDEO PROVIDER LICENSED BY MPEG LA TO PROVIDE MPEG-4 VIDEO. NO LICENSE IS GRANTED OR SHALL BE IMPLIED FOR ANY OTHER USE. ADDITIONAL INFORMATION INCLUDING THAT RELATING TO PROMOTIONAL, INTERNAL AND COMMERCIAL USES AND LICENSING MAY BE OBTAINED FROM MPEG LA, LLC. SEE [HTTP://WWW.MPEGLA.COM](http://WWW.MPEGLA.COM)
- THIS PRODUCT IS LICENSED UNDER THE VC-1 PATENT PORTFOLIO LICENSE FOR THE PERSONAL AND NON-COMMERCIAL USE OF A CONSUMER TO
(i) ENCODE VIDEO IN COMPLIANCE WITH THE VC-1 STANDARD (“VC-1 VIDEO”) AND/OR (ii) DECODE VC-1 VIDEO THAT WAS ENCODED BY A CONSUMER ENGAGED IN A PERSONAL AND NON-COMMERCIAL ACTIVITY AND/OR WAS OBTAINED FROM A VIDEO PROVIDER LICENSED TO PROVIDE VC-1 VIDEO. NO LICENSE IS GRANTED OR SHALL BE IMPLIED FOR ANY OTHER USE. ADDITIONAL INFORMATION MAY BE OBTAINED FROM MPEG LA, L.L.C. SEE [HTTP://WWW.MPEGLA.COM](http://WWW.MPEGLA.COM)

Important Notice on Software

The software embedded in this product comprises a number of independent software components, each of which is copyrighted by JVCKENWOOD Corporation or by a third party.

This product uses software components that are based on an End-User License Agreement (hereinafter called “EULA”) stipulated by JVCKENWOOD Corporation and by third parties.

The EULA dictates the availability of the source codes of free-software components as a prerequisite to distributing them in executable form under the terms of the GNU General Public License or the Lesser General Public License (hereinafter called “GPL/LGPL”). To get information about the software components that are subject to the terms of the GPL/LGPL, please visit the following Website:

Website URL <https://www2.jvckenwood.com/gpl/>

Queries concerning the contents of the source code or the like will not be accepted.

Please note that software components based on a EULA that is not subject to the terms of the GPL/LGPL or those that have been developed or created by JVCKENWOOD Corporation will be excluded from the scope of source code disclosure.

Because licenses to use software components distributed under the GPL/LGPL are offered to the customers for free of charge, no warranty is granted to the customers, whether explicitly or implicitly, to the extent of the applicable laws.

Unless otherwise stipulated by the applicable laws or agreed upon in writing, the copyright holders or those who are entitled to modify and redistribute the software components are not held responsible for any and all damages resulting from their use or from inability to use them. For more information about the terms of use of the software components, required items of compliance and so on, please refer to the GPL/LGPL.

Customers wishing themselves to use a software component that is subject to the GPL/LGPL embedded in this product are encouraged to read the terms of the corresponding license before use. Because each individual license is prescribed by a third party other than JVCKENWOOD Corporation, the original (English) of the license is presented.

EULA

Software License Agreement

JVCKENWOOD Corporation (hereinafter called "Licensor") holds either the copyright to the embedded software or the right to sublicense it. This agreement establishes the conditions under which the customer uses this "Licensed Software."

The customer shall agree to the terms of this license agreement before proceeding to use Licensed Software.

This agreement is deemed to have taken effect when the customer (hereinafter called "User") has used a product implementation of Licensed Software.

The Licensed Software may contain software Licensor has been licensed to use by third parties directly or indirectly. Some third parties may have terms of use prescribed for their customers, apart from this Software License Agreement. This agreement does not apply to such software. Be sure to consult "Important Notice on Software" as presented separately.

Article 1 (General)

Licensor grants to User a non-exclusive, non-assignable right of use Licensed Software within the country where the User purchases the Product (hereinafter the "Country") (except for the exception provided for in Paragraph 1, Article 3).

Article 2 (Right of Use)

1. The right of use granted under this agreement is the right to use Licensed Software in this product.

2. User may not duplicate, copy, modify, add to, translate or otherwise alter, or loan licensed Software and the associated literature in whole or in part.
3. Use of Licensed Software is limited to a private extent, and Licensed Software may not be distributed, licensed or sublicensed for any purposes whatsoever, including commercial use.
4. User shall use Licensed Software as per the instruction manual or instructions given in the help file and may not use or duplicate data in violation of the regulations of the Copyright Law or other governing laws by using Licensed Software in whole or in part.

Article 3 (Terms of License)

1. In assigning this product, User may not retain the original copy of the embedded Licensed Software (including associated literature, updates and upgrades) and any duplicates and associated literature with regard to the license to use Licensed Software. User may transfer Licensed Software only to the condition of binding the assignee to abide by the terms of this Software License Agreement.
2. User may not reverse-engineer, disassemble, decompile or otherwise analyze the source code of Licensed Software.

Trademarks and Licenses

Article 4 (Rights to Licensed Software)

All rights to Licensed Software and the associated literature, including copyrights, shall reside with Licensor or the original right holder who has granted the Right of Use and right to sublicense to Licensor (hereinafter referred to as "Original Right Holder"), and User does not have any rights other than Right of Use granted hereunder with regard to Licensed Software and the associated literature.

Article 5 (Exemption Granted to Licensor)

1. Licensor and Original Right Holder do not assume any responsibility for damages caused to User or third parties resulting from the exercise by User of the license granted hereunder, unless otherwise provided by any law to the contrary.
2. Licensor does not warrant Licensed Software to be merchantable, compatible and fit for specific purposes.

Article 6 (Responsibility for Third Parties)

If disputes over the infringement of third parties' intellectual property rights, such as copyrights and patent rights, arise out of the use of Licensed Software by User, User shall resolve these disputes at User's own expenses while keep Licensor and Original Right Holder harmless.

Article 7 (Secrecy Obligation)

User shall keep confidential Licensed Software provided hereunder, information contained in the associated literature or the like and those provisions of this agreement not yet in public knowledge and may not disclose or leak these to third parties without prior written consent from Licensor.

Article 8 (Cancellation of the Agreement)

Licensor reserves the right to cancel this agreement forthwith and claim compensation from User for the damages caused by such cancellation when User:
(1) Breaches any of the provisions of this agreement, or
(2) Has received a petition for seizure, provisional seizure, provisional disposition or any other kind of compulsory execution.

Article 9 (Destruction of Licensed Software)

If this agreement is terminated under the provision of the foregoing paragraph, User shall destroy Licensed Software, along with all associated literature and its duplicates, within two (2) weeks from the date of termination.

Article 10 (Copyright Protection)

1. Copyrights and all other intellectual property rights relating to Licensed Software shall reside with Licensor and Original Right Holder and in no circumstances with User.
2. User shall abide by the laws relating to copyrights and intellectual property rights in using Licensed Software.

Article 11 (Export Control)

1. Licensed Software and the associated literature or the like may not be exported to places outside the Country (including transmission outside the Country over the Internet or the like).
2. User agrees that Licensed Software is subject to export controls imposed by the Country and the United States of America.

3. User agrees to comply with all the international and domestic laws that apply to this software (U.S. Export Administration Regulations and regulations established by the U.S., the Country and their governmental agencies regarding usage by end users and export destinations).

Article 12 (Miscellaneous)

1. Even if this agreement is invalidated in part by law, all other provisions shall remain in effect.
2. Licensor and User shall consult each other in good faith to resolve any matters not provided for in this agreement or questions arising from the interpretation of this agreement.
3. Licensor and User agree that this agreement is governed by the law of Japan and that all dispute involving claims and obligations that may arise out of this agreement will be settled by arbitration at the Tokyo District Court as the court of first instance.

For updated information (the latest Instruction Manual, system updates, new functions, etc.),
please visit the following website:

<<https://www.kenwood.com/cs/ce/>>

