

GARMIN®



GARMIN DASH CAM™ X310

Owner's Manual

© 2024 Garmin Ltd. or its subsidiaries

All rights reserved. Under the copyright laws, this manual may not be copied, in whole or in part, without the written consent of Garmin. Garmin reserves the right to change or improve its products and to make changes in the content of this manual without obligation to notify any person or organization of such changes or improvements. Go to www.garmin.com for current updates and supplemental information concerning the use of this product.

Garmin® and the Garmin logo are trademarks of Garmin Ltd. or its subsidiaries, registered in the USA and other countries. Garmin Dash Cam™, Garmin Express™, and Travelapse™ are trademarks of Garmin Ltd. or its subsidiaries. These trademarks may not be used without the express permission of Garmin.

The BLUETOOTH® word mark and logos are owned by the Bluetooth SIG, Inc. and any use of such marks by Garmin is under license. microSD® and the microSD logo are trademarks of SD-3C, LLC. USB-C® is a registered trademark of USB Implementers Forum. Wi-Fi® is a registered mark of Wi-Fi Alliance Corporation.

Table of Contents

Getting Started	1	Connecting Your Camera to a Wi-Fi Network.....	15
Device Overview.....	1	Viewing Videos on Your Smartphone..	15
Installing a Memory Card.....	2	Vault Storage.....	16
Mounting Considerations.....	2	Editing and Exporting a Video.....	17
Installing the Camera on Your Windshield.....	3	Multiple Camera Network.....	17
Connecting the Camera to Vehicle Power.....	5	Camera Settings in the Garmin Drive App.....	18
Setting the Camera Placement.....	6	Settings	19
Turning On the Device Manually.....	6	Camera Settings.....	19
Turning Off the Device Manually.....	6	Driver Assistance Settings.....	19
Main Menu.....	6	Display and Volume Settings.....	20
Dash Cam Recording	7	System Settings.....	20
Saving a Video Recording.....	7	Device Information	21
Event Detection.....	7	Status LED.....	21
Turning Audio Recording On or Off.....	7	Cleaning the Camera Lens.....	21
Travelapse.....	7	Product Updates.....	21
Parking Guard	8	Garmin Support Center.....	22
Enabling or Disabling Parking Guard.....	8	Viewing E-Label Regulatory and Compliance Information.....	22
Parking Guard Settings.....	8	Restarting the Device.....	22
Viewing Videos	8	Specifications.....	22
Saving Unsaved Video Footage.....	9	Memory Card Specifications.....	22
Deleting a Video.....	9	Appendix	23
Videos on Your Computer.....	9	Constant Power Cable.....	23
Driver Awareness Features and Alerts	10	Parking Mode Cable.....	25
Forward Collision Warning System.....	11	Troubleshooting	26
Lane Departure Warning System.....	12	My camera feels warm while it is operating.....	26
Go Alert.....	13	My memory card has degraded and needs to be replaced.....	26
Red Light and Speed Cameras.....	13	My video recordings are blurry.....	26
Voice Control	13	My video recordings are choppy or incomplete.....	27
Controlling the Camera Using Voice Commands.....	14		
Turning Voice Control On or Off.....	14		
Voice Control Tips.....	14		
Changing the Wake Word.....	14		
Pairing with Your Smartphone	15		



Getting Started

⚠ WARNING

See the *Important Safety and Product Information* guide in the product box for product warnings and other important information.

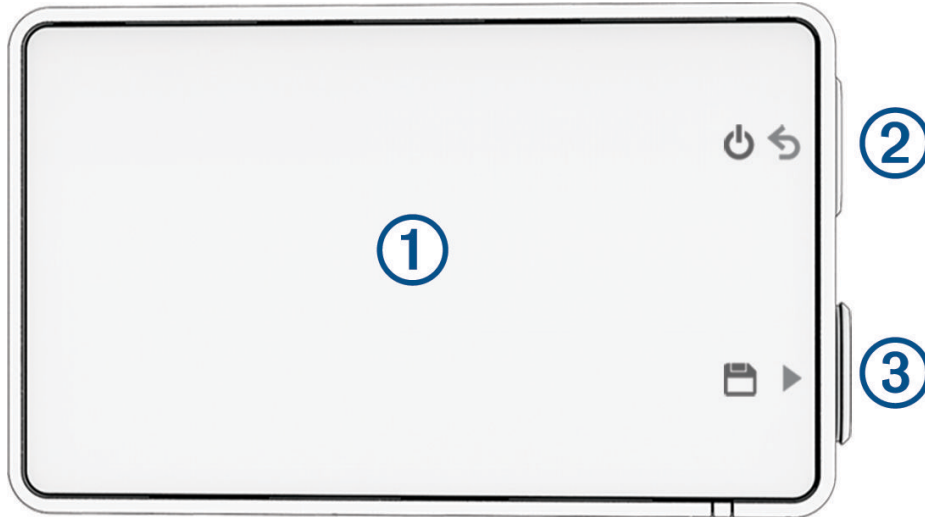
Device Overview



①	Touchscreen	Swipe left to open the menu. Swipe up or down to scroll the menu. Swipe right to close the menu or return to the previous menu. Touch to choose an option in the menu.
②		Press to turn the device on. Hold for 3 seconds to turn the device off. Press to return to the previous page.
③		From the viewfinder, press to save a video.

Installing a Memory Card

To record video, you must install a compatible memory card ([Memory Card Specifications, page 22](#)).

- 1 Insert the memory card ① into the slot ②.

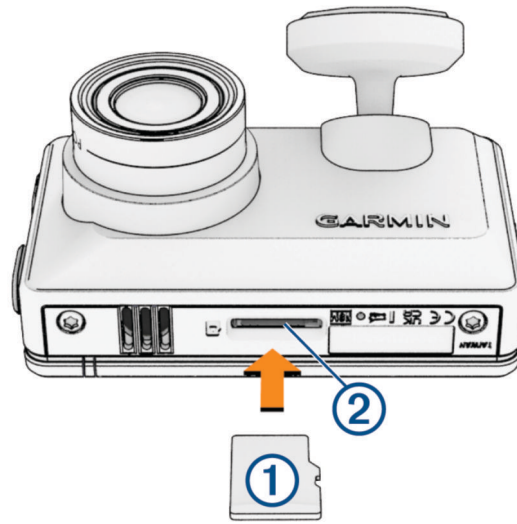

- 2 Press it in until it clicks.

Formatting the Memory Card

The camera requires a memory card formatted using the exFAT file system. You can use the camera to format your card using this file system.

You should format your memory card at least one time every 6 months to help extend the useful life of the memory card. You must also format a brand new memory card if it is not formatted using the exFAT file system.

NOTE: Formatting the memory card deletes all videos and data on the card.

- 1 Connect the camera to power.
- 2 Swipe left to open the menu.
- 3 Select **Settings > Camera > Format Card**.
- 4 Keep the camera connected to power until the formatting is complete.

When formatting is complete, the camera displays a message and begins recording.

Removing the Memory Card

NOTICE

Removing the memory card while the device is turned on can result in a loss of data or damage to the device.

- 1 Turn off the device.
- 2 Press the card in until it clicks.
- 3 Release the card.
The card ejects from the slot.

Mounting Considerations

The camera affixes to the windshield using the included adhesive mount. The adhesive mount is difficult to remove after it is installed. You should carefully consider the mounting location before you install the mount.

- Do not mount the camera in a location that interferes with the driver's view of the road.
- You should choose a mounting location that provides the camera a clear view of the road ahead.
- You should verify the area of the windshield in front of the camera is cleared by the windshield wipers.
- You should avoid placing the camera behind a tinted area of the windshield.

Installing the Camera on Your Windshield

NOTICE

The adhesive mount is intended for a long-term installation and can be difficult to remove. You should carefully consider the mounting location before you install the mount.

Before you can install the adhesive mount onto your windshield, you should review the windshield mounting considerations ([Mounting Considerations, page 2](#)).

For the best results, the ambient temperature should be from 21° to 38°C (from 70° to 100°F) while installing the camera on your windshield. The adhesive may not bond correctly if the temperature is outside this range. If you need to install the camera at lower temperatures, you must clear all snow, ice, and moisture from the windshield and warm the windshield using the vehicle defroster before installing the camera.

The camera attaches to the windshield using the included adhesive mount.

- 1 Clean the inside of the windshield using water or alcohol, and a lint-free cloth.
The windshield must be free of dust, wax, oils, or coatings.
- 2 Hold the camera in the desired mounting location on the windshield, and verify the camera has a clear, unimpeded view.
- 3 After you have selected a mounting location with a clear view, remove the protective film from the mount adhesive.

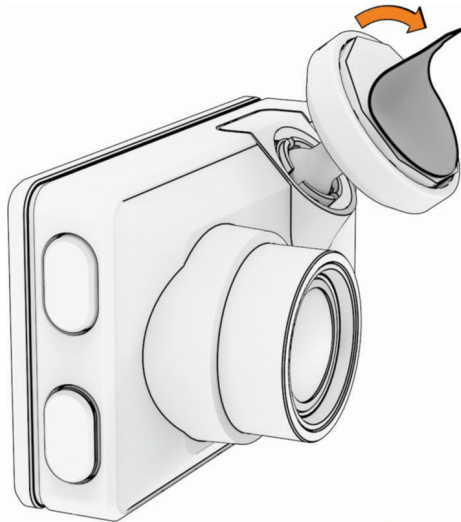

4 Position the mount over the mounting location.

TIP: The adhesive is extremely sticky. Avoid touching the adhesive to the windshield until the mount is properly positioned.

5 Press the mount firmly onto the windshield, and maintain pressure for 30 seconds.

This helps to ensure the mount adhesive has proper contact with the windshield.

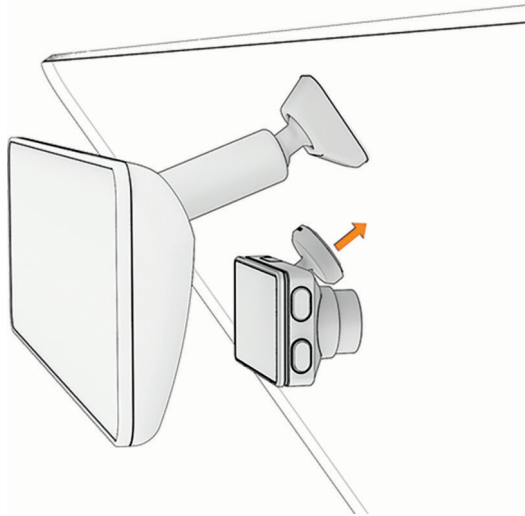

Connecting the Camera to Vehicle Power

- 1 Plug the power cable into the USB port on the camera.

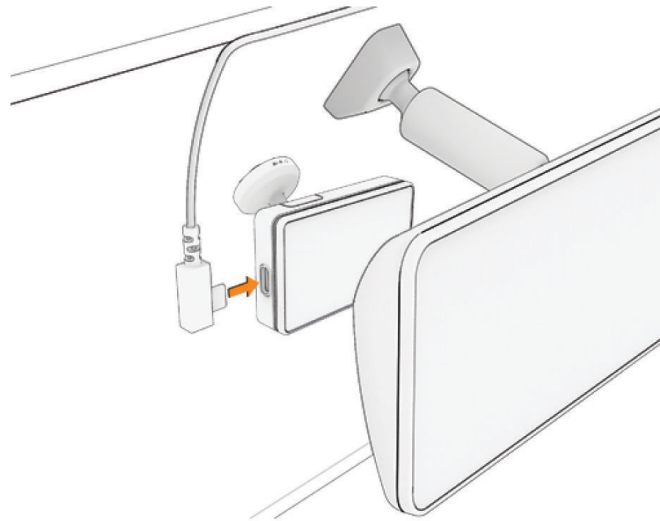

- 2 Route the power cable to your vehicle power outlet.

NOTE: You should power the camera using the included vehicle power adapter and avoid using a vehicle USB port. A vehicle USB port may not provide enough power for reliable camera operation. Also, the camera may enter USB mass storage mode if you connect it to a vehicle USB port using a cable that allows data transfer (not included). The camera cannot record video or connect to your smartphone while it is in USB mass storage mode.

The included lightweight power cable is designed to be routed out of sight. To hide the power cable, route it behind the vehicle trim along the windshield, doorframe, or dash.

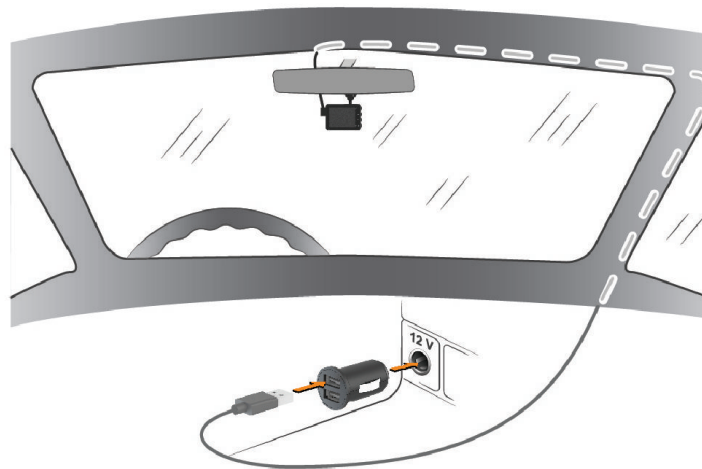

- 3 Plug the Garmin Dash Cam power cable into the included vehicle power adapter.
- 4 Plug the vehicle power adapter into the power outlet in your vehicle.
- 5 If necessary, turn on the vehicle ignition switch to provide power to the power outlet in your vehicle. The camera turns on and starts recording.

Setting the Camera Placement

You can mount the device in the left, center, or right of your windshield. For the best performance of driver assistance features, you should set the Camera Placement option to indicate the location of your device in the vehicle.

- 1 Swipe the screen left to open the menu.
- 2 Select **Settings** > **Driver Assistance** > **Camera Placement**.
- 3 Select **Horizontal Placement**, and select the horizontal placement of your camera.
- 4 Select **Vehicle Height**.
- 5 Select an option:
 - If you are driving a large vehicle, like a full size van or truck, select **Tall**.
 - If you are driving a car, select **Normal**.

Turning On the Device Manually

Before you turn on the device using battery power, you should fully charge the battery.

NOTE: When the device is connected to an ignition-switched power outlet, it turns on automatically when you turn on the vehicle.

Select .

The device turns on.

Turning Off the Device Manually

NOTE: When the device is connected to an ignition-switched power outlet, it turns off automatically when you turn off the vehicle.

Hold  for 3 seconds.

If the device is connected to a Wi-Fi® network with an active Vault subscription, it uploads available videos to the Vault before it turns off.

If your device is connected to external power, it enables the Parking Guard feature after five seconds. If necessary, you can follow the on-screen instructions to turn off the device before it enables the Parking Guard feature.

Main Menu

From the viewfinder, swipe left to open the main menu. Swipe up or down to scroll through the main menu. Touch a menu item to select it.

Gallery: Allows you to view and manage recorded videos ([Viewing Videos, page 8](#)).

Garmin Drive App: Allows you to pair your camera with your smartphone and the Garmin Drive™ app ([Pairing with Your Smartphone, page 15](#)).

Settings: Allows you to set up camera features, change system settings, and view system information ([Settings, page 19](#)).

Voice Control: Allows you to enable and disable the voice control features ([Voice Control, page 13](#)).

Travelapse: Allows you to start and stop Travelapse™ recording ([Travelapse, page 7](#)).

Dash Cam Recording

NOTICE

Some jurisdictions may prohibit or regulate recording audio and video, or taking photographs. Jurisdictions may require that all parties have knowledge of the recording and provide consent before you record audio and video or take photographs. It is your responsibility to know and comply with all laws, regulations, and any other restrictions in your jurisdiction.

The dash cam records video to the camera memory card ([Installing a Memory Card, page 2](#)). By default, the device immediately starts recording video when it turns on, and it continues recording until it is turned off. If the memory card is full, the device automatically deletes the oldest unsaved video to create space for new video.

When the option to promptly delete unsaved video is enabled, the device continually deletes unsaved video more than three minutes old and deletes all unsaved video each time it is powered off. You can enable or disable this feature in the camera settings ([Camera Settings, page 19](#)).

You can save a video recording to prevent it from being overwritten or deleted ([Saving Unsaved Video Footage, page 9](#)).

Saving a Video Recording

By default, the device uses a sensor to detect a possible incident and automatically saves video footage recorded 15 seconds before and 15 seconds after the detected event. You can also save video files manually at any time.

Press .

The device saves the video footage recorded before, during, and after you press .

TIP: You can also save video files using voice commands ([Voice Control, page 13](#)).

The memory card has limited storage. After you save a video recording, you should transfer the recording to your smartphone ([Editing and Exporting a Video, page 17](#)) or to your computer ([Videos on Your Computer, page 9](#)).

Event Detection

By default, the device uses a sensor to detect possible incidents and automatically saves video footage recorded 15 seconds before and 15 seconds after the detected event. The video footage is stamped with the time, date, and location of the event.

Turning Audio Recording On or Off

NOTICE

Some jurisdictions may prohibit recording audio in the vehicle or may require that all passengers have knowledge of the recording and provide consent before you record audio in the vehicle. It is your responsibility to know and follow all laws and restrictions for your jurisdiction.

The device can record audio using the integrated microphone while recording video. You can turn audio recording on or off at any time.

- 1 Swipe the screen left to open the menu.
- 2 Select **Settings** > **Camera** > **Record Audio**.

TIP: You can also turn audio recording on or off using voice commands ([Voice Control, page 13](#)).

Travelapse

The Travelapse feature captures a fast-motion video of your trip, which allows you to share a short video of all the places you traveled. Recording Travelapse does not stop dash cam recording.

NOTE: Travelapse recording is not available when the option to promptly delete unsaved video is enabled ([Camera Settings, page 19](#)).

Recording a Travelapse Video

You can manually start and stop Travelapse recording at any time using the main menu or voice commands.

NOTE: The device continues to record regular dash cam footage while recording a Travelapse video.

- To start recording a Travelapse video, select an option:
 - From the main menu, select **Travelapse > Start**.
 - Say **OK, Garmin, Start Travelapse**.
- To stop Travelapse recording, select an option:
 - From the main menu, select **Travelapse > Stop**.
 - Say **OK, Garmin, Stop Travelapse**.

Parking Guard

The Parking Guard feature allows the camera to record video automatically while your vehicle is parked. When you turn off your vehicle, the camera automatically enters parked recording mode. The camera automatically records video each time it detects an incident. If you have an active Vault subscription, the camera sends a notification to your smartphone when the camera is connected to a Wi-Fi network. You can manage Parking Guard settings from the Garmin Drive app on your smartphone.

Enabling or Disabling Parking Guard

- 1 Swipe the screen left to open the menu.
- 2 Select an option:
 - To enable Parking Guard features, select **Settings > Parking Guard > Enable**.
 - To disable Parking Guard features, select **Settings > Parking Guard > Settings > Enable**.

Parking Guard Settings

Swipe the screen left to open the menu, and select **Settings > Parking Guard > Settings**.

Enable: Enables or disables the Parking Guard feature.

Auto Start: Sets the amount of time the vehicle must remain still before the camera turns on the Parking Guard feature.

Impact Sensitivity: Adjusts the sensitivity level for incident detection while the Parking Guard feature is active.

Monitoring Time: Sets the amount of time the Parking Guard feature remains active before it turns off.

Run on Battery: Sets the Parking Guard feature to use the camera battery if an external power source is not connected.

NOTE: If you touch the camera while the Run on Battery setting is enabled, it may turn on unexpectedly when it detects motion.

Record Before Incident: Sets the device to record 15 seconds before incidents are detected. You must connect your camera to an external power source to use this option.

Viewing Videos

NOTE: The device stops recording and alerts are disabled while viewing videos.

- 1 Swipe the screen left to open the menu.
- 2 Select **Gallery**.
- 3 Select an option:

NOTE: Unsaved videos and Travelapse videos are not available when the option to promptly delete unsaved video is enabled ([Camera Settings, page 19](#)).

- To view videos you saved, select **Saved Videos**.
- To view recent video footage that has not been saved, select **Temporary Videos**.

- 4 Select a video.

Saving Unsaved Video Footage

You can view your unsaved temporary footage in the gallery and save video clips from the unsaved footage. This feature is not available when the option to promptly delete unsaved video is enabled ([Camera Settings, page 19](#)).

- 1 Swipe the screen left to open the menu.
- 2 Select **Gallery > Temporary Videos**.
- 3 Select a day and time.
The unsaved video for that timeframe starts playing.
- 4 Touch the screen to open the control menu.
- 5 Drag the slider left or right to move backward or forward through the video.
- 6 When you find the video footage you want to save, press .
The device saves a 30-second video clip that includes 15 seconds before and 15 seconds after the selected save point.

Deleting a Video

- 1 While viewing a video in the gallery, tap the screen to open the menu.
- 2 Select  > **Yes**.

Videos on Your Computer

NOTE: Some media players might not support high-resolution playback.

Videos are stored in the DCIM directory on the camera memory card. Videos are stored in HEVC (H.265) MP4 file format. You can view and transfer videos by connecting the memory card or the device to your computer ([Connecting the Camera to Your Computer, page 10](#)). Go to garmin.com/dashcamvideos for more information.

The videos are sorted into several folders.

NOTE: Unsaved videos and Travelapse videos are not available when the option to promptly delete unsaved video is enabled ([Camera Settings, page 19](#)).

100EVENT: Contains videos saved automatically when the device detects an incident.

102SAVED: Contains videos saved manually by the user.

103PARKM: Contains videos saved while parked.

104TLPSE: Contains Travelapse videos.

105UNSVD: Contains unsaved video footage. The device overwrites the oldest unsaved video when the storage space for unsaved videos is full.

Connecting the Camera to Your Computer

You can connect the camera to your computer to install software updates or transfer videos to your computer.

NOTE: The power cable included with your device is intended for power only, and it cannot be used to connect to your computer.

- 1 Using a compatible USB-C® data cable, plug the data cable into the USB-C port on the camera.



- 2 Plug the other end of the cable into a compatible USB port on your computer.
Depending on your computer operating system, the device appears as either a removable drive or a removable volume on your computer.

Driver Awareness Features and Alerts

Your camera provides features that can help encourage more attentive driving, even when you are driving in a familiar area. The device plays an audible tone or message and displays information for each alert. You can enable or disable the audible tone for some types of driver alerts.

Forward collision warning: The device alerts you when it detects that you are not maintaining a safe distance between your vehicle and the vehicle in front of you.

Lane departure warning: The device alerts you when it detects you may be crossing a lane boundary unintentionally.

Go alert: The device plays a tone and displays an alert when stopped traffic starts moving.

Speed cameras: The device plays a tone and displays the speed limit and the distance to the speed camera.

Red light cameras: The device plays a tone and displays the distance to the red light camera.

Forward Collision Warning System

WARNING

The forward collision warning system (FCWS) feature is for information only and does not replace your responsibility to observe all road and driving conditions, abide by all traffic regulations, and use safe driving judgment at all times. The FCWS relies on the camera to provide a warning of upcoming vehicles and, as a result, may have limited functionality in low visibility conditions. For more information, go to garmin.com/warnings.

The FCWS feature alerts you when the device detects that there is not a safe distance between your vehicle and the vehicle in front of you. The device determines your vehicle speed using GPS, and it calculates an estimated safe following distance based on your speed. The FCWS activates automatically when your vehicle speed exceeds 65 km/hr (40 mph).

When the device detects that you are too close to the vehicle in front of you, the device plays an audible alert, and a warning appears on the screen.

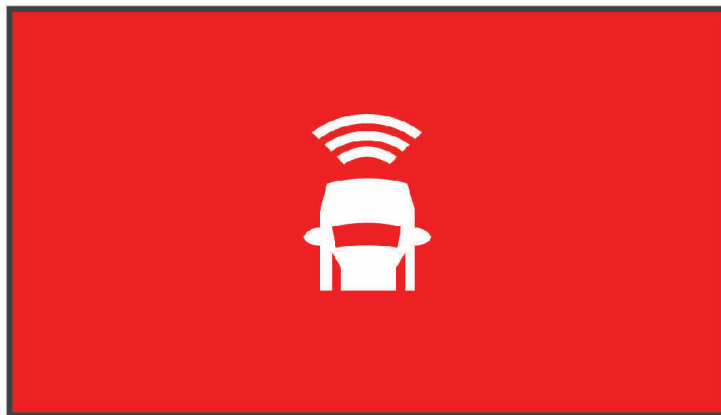

Forward Collision Warning System Performance Tips

Several factors affect the performance of the forward collision warning system (FCWS). Some conditions may prevent the FCWS feature from detecting a vehicle in front of you.

- The FCWS feature activates only when your vehicle speed exceeds 65 km/h (40 mph).
- The FCWS feature may not detect a vehicle in front of you when the camera's view of the vehicle is obscured by rain, fog, snow, sun or headlight glare, or darkness.
- The FCWS feature may not function properly if the camera is incorrectly aligned ([Setting the Camera Placement, page 6](#)).
- The FCWS feature may not detect vehicles farther away than 40 m (130 ft.) or closer than 5 m (16 ft.).
- The FCWS feature may not function properly if the camera placement settings do not correctly indicate your vehicle height or the placement of your device in the vehicle ([Setting the Camera Placement, page 6](#)).

Lane Departure Warning System

⚠ WARNING

The lane departure warning system (LDWS) feature is for information only and does not replace your responsibility to observe all road and driving conditions, abide by all traffic regulations, and use safe driving judgment at all times. The LDWS relies on the camera to provide warnings for lane markers and, as a result, may have limited functionality in low visibility conditions. For more information, go to garmin.com/warnings.

The LDWS feature alerts you when the device detects you may be crossing a lane boundary unintentionally. For example, the device alerts you if you cross some solid-painted lane boundaries. The LDWS feature provides alerts only when your vehicle speed exceeds 65 km/h (40 mph). The alert appears on the left or right side of the screen to indicate which lane boundary you crossed.



NOTE: For the best LDWS performance, you should set the Camera Placement option to indicate the location of the device in your vehicle.

Lane Departure Warning Performance Tips

Several factors affect the performance of the lane departure warning system (LDWS). Some conditions may prevent the LDWS feature from detecting lane departures.

- The LDWS feature provides alerts only when your vehicle speed exceeds 65 km/h (40 mph).
- The LDWS feature may not function properly if the camera is incorrectly aligned.
- The LDWS feature may not function properly if the camera placement settings do not correctly indicate your vehicle height or the placement of your device in the vehicle ([Setting the Camera Placement, page 6](#)).
- The LDWS feature requires a clear, continuous view of the lane divider lines.
 - Lane departures may not be detected when divider lines are obscured by rain, fog, snow, extreme shadows, sun or headlight glare, road construction, or any other visual obstruction.
 - Lane departures may not be detected if lane divider lines are misaligned, missing, or heavily worn.
- The LDWS feature may not detect lane departures on extremely wide, narrow, or winding roads.

Go Alert

The go alert plays a tone and displays an alert when stopped traffic ahead of your vehicle starts moving again. This alert appears only after the vehicle ahead has moved a substantial distance and your vehicle has remained stopped. This can be useful at stop lights or in traffic delays. This feature uses the dash camera to detect the stopped or moving vehicle and requires a clear view of the road.



Red Light and Speed Cameras

NOTICE

Garmin® is not responsible for the accuracy of or the consequences of using a red light or speed camera database.

NOTE: This feature is not available for all regions or product models.

Information about red light and speed camera locations is available in some areas and for some product models with a paid subscription. The device alerts you when you approach a reported speed or red light camera.

- In some areas, your device can receive red light and speed camera data while connected to a smartphone running the Garmin Drive app.
- You can use the Garmin Express™ software (garmin.com/express) or the Garmin Drive app to update the camera database stored on your device. You should update your device frequently to receive the most up-to-date camera information.

Voice Control

The voice control feature allows you to control your camera by saying words and commands.

NOTE: The voice control feature is not available for all languages. You can use this feature while the interface is set to an unsupported language, but you must speak the commands in English.

Controlling the Camera Using Voice Commands

- 1 Say **OK, Garmin** to activate the voice control feature.
The camera plays a tone and starts listening for a command.
- 2 Say a command:
 - To save a video, say **Save Video**.
 - To enable audio recording for your videos, say **Record Audio**.
 - To disable audio recording for your videos, say **Stop Audio**.
 - To start Travelapse recording, say **Start Travelapse**.
 - To stop Travelapse recording, say **Stop Travelapse**.The camera plays a tone when it recognizes your command.

Turning Voice Control On or Off

- 1 Swipe the screen left to open the menu.
- 2 Select **Voice Control > Settings > Enable**.

Voice Control Tips

- Speak in a normal voice directed at the device.
- Reduce background noise to increase the accuracy of the voice recognition.
- Before each command, say the wake word. The default wake word is **OK, Garmin**.
- Listen for a tone to confirm that the camera successfully recognized a command.
- Change the wake word if you have more than one Garmin device with voice control features ([Changing the Wake Word, page 14](#)).

Changing the Wake Word

By default, your dash camera's voice control activates when you say OK, Garmin. You can change the wake word at any time. This can be useful if you have more than one Garmin device with voice control features.

- 1 Swipe the screen left to open the menu.
- 2 Select **Voice Control > Settings > Wake Word**.
- 3 Select a wake word.

Pairing with Your Smartphone

You can pair your camera with your smartphone and the Garmin Drive app. The Garmin Drive app allows you to set up a multiple-camera network, change camera settings, and view, edit, and save videos. You can also upload, manage, and share footage on a secure, online storage drive using the Vault.

NOTE: Remote Wi-Fi network features and Vault features require a paid subscription ([Subscribing to Vault](#), page 16).

- 1 From the app store on your smartphone, install the  Garmin Drive app.
- 2 Connect the camera to power using the included vehicle power adapter and cable.
The camera turns on.
- 3 Place the camera and your smartphone within 3 m (10 ft.) of each other.
- 4 On your phone, open the Garmin Drive app.
- 5 Select an option:
 - If this is the first Garmin device you are pairing with your smartphone, accept the Garmin Drive app license agreements.
 - If you are pairing an additional Garmin camera with your smartphone, select **Add Another Device**.
- 6 Select **Garmin Dash Cam Series**.
- 7 On your camera, swipe left to open the menu.
- 8 Select **Get the App**.
- 9 Follow the on-screen instructions on your phone to complete the pairing and setup process.

After pairing is complete, the main app dashboard appears. After the camera and smartphone are paired, they connect automatically when they are turned on and within range.

Connecting Your Camera to a Wi-Fi Network

NOTE: Remote Wi-Fi network features and Vault features require a paid subscription ([Subscribing to Vault](#), page 16).

To connect the camera to an existing Wi-Fi network, the network must be set up to allow connected devices to see and communicate with each other.

You can use the Garmin Drive app to connect your camera to a Wi-Fi network.

While connected to a Wi-Fi network, your camera automatically uploads full-resolution videos to the Vault when it detects an incident. You can also connect to your camera remotely using the Garmin Drive app to view a live video feed ([Viewing the Live View Camera Feed](#), page 16).

- 1 Connect your camera to the Garmin Drive app ([Pairing with Your Smartphone](#), page 15).
- 2 From the Garmin Drive app, select , and select your vehicle and camera name.
- 3 Select **Wi-Fi Connections**.
A list of nearby Wi-Fi access points appears.
- 4 Select your Wi-Fi network, and enter the network password.
The camera connects to the Wi-Fi network.

The camera saves the network information and connects automatically the next time the camera is turned on and within range of the network.

Viewing Videos on Your Smartphone

Before you can view videos on your smartphone, you must pair your Garmin Dash Cam device with the Garmin Drive app ([Pairing with Your Smartphone](#), page 15).

NOTE: The device stops recording and alerts are disabled while viewing videos.

- 1 From the Garmin Drive app on your smartphone, select **Review Video**.
- 2 Select an option:
 - To view a video you saved, select a file from the **Saved** category.
 - To view recent video footage that has not been saved, select a video from the **Temporary** category.

Viewing the Live View Camera Feed

Before you can view the Live View camera feed remotely, you must have an active Vault subscription and you must connect your camera to a Wi-Fi network ([Connecting Your Camera to a Wi-Fi Network, page 15](#)).

You can also connect your camera to a constant 12V power source ([Constant Power Cable, page 23](#)).

You can view the live camera feed using the Live View feature in the Garmin Drive app. You can connect directly to your paired camera using Bluetooth® technology, or you can connect remotely using a Wi-Fi network.

- 1 From the Garmin Drive app on your smartphone, select **Live View**.
The app scans for available cameras.
- 2 If necessary, select your camera from the list of available devices.
The live view appears.

Deleting a Video Using Your Smartphone

- 1 When you are viewing the list of saved videos on your smartphone, select **Select**.
- 2 Select one or more files.
- 3 Select .

Vault Storage

NOTE: This feature requires an active Vault subscription. Vault features are not available for all countries.

You can upload, manage, and share dash camera videos on a secure, online storage drive using the Vault. With a paid subscription, the dash camera uploads saved videos to the Vault automatically while it is connected to a Wi-Fi network.

You can purchase a Vault subscription from the Garmin Drive app on your smartphone.

NOTE: Your dash camera must be connected to a Wi-Fi network to use this feature.

Subscribing to Vault

You can purchase a Vault subscription to store your videos in a secure online storage server.

- 1 From the Garmin Drive app on your smartphone, select your device.
- 2 Select **Settings > Vault Storage > Choose a Plan**.
- 3 Follow the on-screen instructions.

Sharing a Video

You can share a secure link to a dash camera video from the Vault.

NOTE: An active Vault subscription is required to use this feature.

- 1 From the Garmin Drive app on your smartphone, select **Vault**.
- 2 Select a video, and select **Secure Share**.
- 3 Follow the on-screen instructions.

Disabling a Shared Video Link

You can disable a link to a video that you previously shared from the Vault. When you disable a shared video link, the video is set to private and the shared link and passcode are disabled.

- 1 From the Garmin Drive app on your smartphone, select **Vault**.
- 2 Select a video, and select **Disable Link > Continue**.

Removing a Video from the Vault

- 1 From the Garmin Drive app on your smartphone, select **Vault**.
- 2 Select a video, and select **Remove From Vault > Continue**.

Editing and Exporting a Video

You can trim the length of your video to remove unnecessary footage before exporting it to the Vault.

NOTE: Videos stored in the Vault cannot be trimmed.

- 1 While viewing a video, drag the trimming handles ① on the video progress bar left or right to trim the video length.

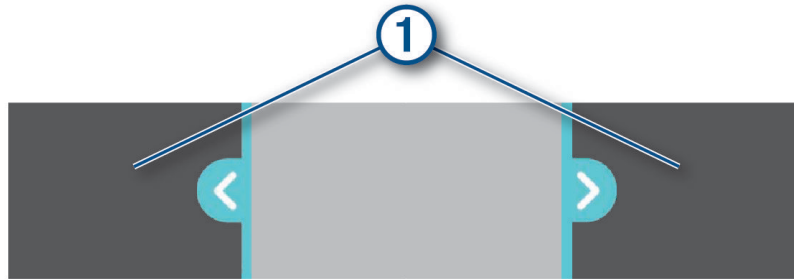

- 2 Select the **Include Audio** check box to include the recorded audio (optional).

- 3 Select **Export**.

NOTE: You must keep the app in the foreground while exporting a video.

The app exports the trimmed video.

- 4 After the video export is complete, select an option:

- To save the video to your phone, select **Save to Phone**.
- To remove the video from the camera memory card, select **Remove From Camera**.
- To return to the gallery, select **Done**.

Multiple Camera Network

You can install multiple dash cameras in the same vehicle, such as front and rear cameras, and create composite picture-in-picture videos from the simultaneous recordings. You can pair multiple dash cameras with the Garmin Drive app. If a GPS-connected camera is part of the network, you can add location information to saved videos for all cameras on the network.

Creating Picture-in-Picture Multi-Camera Videos

Before you can use this feature, you must pair at least two cameras with the Garmin Drive app and record footage using both cameras.

The Garmin Drive app allows you to create composite, picture-in-picture videos from footage recorded at the same time on two cameras.

- 1 From the Garmin Drive app, select **Review Video**.

- 2 Select a multi-camera video.

Multi-camera videos are indicated by multiple camera icons  on the video thumbnail. The app automatically combines video recorded at the same time into one multi-camera video icon.

- 3 Select ◀ and ▶ to choose the camera footage to use for the fullscreen portion of the video.

- 4 Drag the handles on the video progress bar to the left or right to trim the video length.

- 5 Select **Continue**.

- 6 Select ◀ and ▶ to choose the camera footage to use for the picture-in-picture portion of the video.

- 7 Select the corner of the screen where you want the picture-in-picture footage to appear, and select **Export**.

NOTE: You must keep the app in the foreground when exporting a video.

The app exports the picture-in-picture video to your smartphone.

Camera Settings in the Garmin Drive App

Recording Settings

From the Garmin Drive app, select , and select the vehicle and the camera name.

Data Overlay: Adjusts the type of data displayed on videos.

Exposure Value: Adjusts the level of light exposure in videos.

Incident Detection: Adjust the sensitivity level for incident detection.

Resolution: Adjusts the video resolution.

Travelapse: Enables or disables the Travelapse feature ([Travelapse, page 7](#)).

Unsaved Videos: Sets when the device deletes unsaved video footage. When the **Delete When Full** option is selected, the device deletes the oldest unsaved video when the memory card storage is full. When the **Promptly Delete** option is selected, the device continually deletes unsaved video more than three minutes old and deletes all unsaved video each time it is powered off. This is useful to help protect data privacy. While the Promptly Delete option is selected, you cannot record Travelapse videos.

Setup Settings

From the Garmin Drive app, select , and select the vehicle and camera name.

Finish Setup: Provides options to finish setup steps that may not have been completed during installation.

Vault Storage: Provides options for available Vault subscriptions.

Wi-Fi Connections: Shows the wireless network connection status.

Safety and Security Settings

From the Garmin Drive app, select , and select the vehicle and camera name.

Parking Guard: Enables parking guard and adjusts the parking guard recording settings.

System Settings

From the Garmin Drive app, select , and select the vehicle and camera name.

Alert Volume: Adjusts the volume of camera alerts.

Language: Sets the device language.

Units and Time: Adjusts settings for the date and time format.

Voice Commands: Enables voice commands and sets the voice command language.

Wake Word: Allows you to change the voice control activation word.

Device Settings

From the Garmin Drive app, select , and select the vehicle and camera name.

About Device: Lists the camera software version and unit ID.

Check for Updates: Checks the device for software updates.

Reassign to a Different Vehicle: Sets the vehicle used with the selected camera.

Format SD Card: Formats the memory card and deletes all videos and data on the card.

Help: Opens the product support page for the device.

Restore: Restores the device to factory default settings and unpairs the device from the Garmin Drive app.

Forget Device: Unpairs the device from the Garmin Drive app.

Renaming a Camera

You can change the name of your camera to help differentiate it from other cameras in a multiple camera network.

- 1 From the Garmin Drive app, select your camera.
- 2 Select **Settings** > **Finish Setup** > **Camera Alignment**.
- 3 Select a camera name from the **Camera Name** field.
TIP: You can select Custom to enter a custom camera name.

Settings

Camera Settings

Swipe the screen left to open the menu, and select **Settings** > **Camera**.

Resolution: Adjusts the video resolution.

Incident Detection: Turns on and off incident detection and sets options for incident detection sensitivity ([Event Detection, page 7](#)).

Record Audio: Turns on and off audio recording ([Turning Audio Recording On or Off, page 7](#)).

Data Overlay: Adjusts the type of data displayed on videos.

Temporary Videos: Determines when the device deletes unsaved video footage. When the **Delete When Full** option is selected, the device deletes the oldest unsaved video when the memory card storage is full. When the **Promptly Delete** option is selected, the device continually deletes unsaved video more than three minutes old and deletes all unsaved video each time it is powered off. This is useful to help protect data privacy. While the Promptly Delete option is selected, you cannot record Travelapse videos or view unsaved video in the gallery.

Exposure Value: Sets the light exposure value in videos.

Format Card: Formats the memory card and deletes all videos and data on the card.

Video Resolution Settings

You can set the resolution of video recorded by the camera.

Resolution is the width and height of the video in pixels. FPS is the number of video frames captured each second. HDR combines multiple exposure levels for each video frame and can improve clarity in high contrast or low-light conditions. Settings with a higher resolution or FPS require more memory card space.

Select **Settings** > **Camera** > **Resolution**.

Setting	Resolution
4K, 30fps, HDR	3840 x 2160 px
1080p, 120fps	1920 x 1080 px
1080p, 30fps, HDR	1920 x 1080 px

Driver Assistance Settings

Swipe the screen left to open the menu, and select **Settings** > **Driver Assistance**.

Camera Placement: Allows you to indicate the placement of your device in the vehicle ([Setting the Camera Placement, page 6](#)).

Forward Collision: Adjusts the sensitivity of the FCWS feature.

Go Alert: Turns on or off the go alert display and audible alerts when traffic starts moving ([Go Alert, page 13](#)).

Lane Departure: Adjusts the lane boundary settings ([Lane Departure Warning System, page 12](#)).

Garmin Red Light Cameras: Adjusts the audible red light camera alerts.

Display and Volume Settings

Swipe the screen left to open the menu, and select **Settings > Display & Volume**.

Volume: Adjusts the volume of the camera alerts and video playback.

Saving Video Tone: Turns on and off the audible tone that plays when a video is saved.

Brightness: Adjusts the viewfinder display brightness. If you select the Auto Brightness option, the device automatically adjusts the display brightness based on the ambient light.

Color Mode: Allows you to select day or night color mode for the camera display. If you select the Auto option, the device automatically switches to day or night colors based on the time of day.

Display Timeout: Allows you to set the screen to stay on while the camera is receiving power or turn off after one minute of idle time. The camera continues to record while the screen is off, and the recording LED remains red to indicate the device is recording.

System Settings

Swipe the screen left to open the menu, and select **Settings > System**.

Regulatory: Displays regulatory and compliance information.

Units: Sets the unit of measure used for distances.

Time: Sets the time and format for the time stamp.

Language: Sets all on-screen text to the selected language.

About: Displays the camera name, software version number, the unit ID number, and information about several other software features.

Reset: Restores all settings to the factory default values and unpairs the camera from the Garmin Drive app. This option does not delete recorded videos. To delete all videos on your memory card, you can format the memory card ([Formatting the Memory Card, page 2](#)).

Device Information

Status LED

The status LED ① indicates the device status.

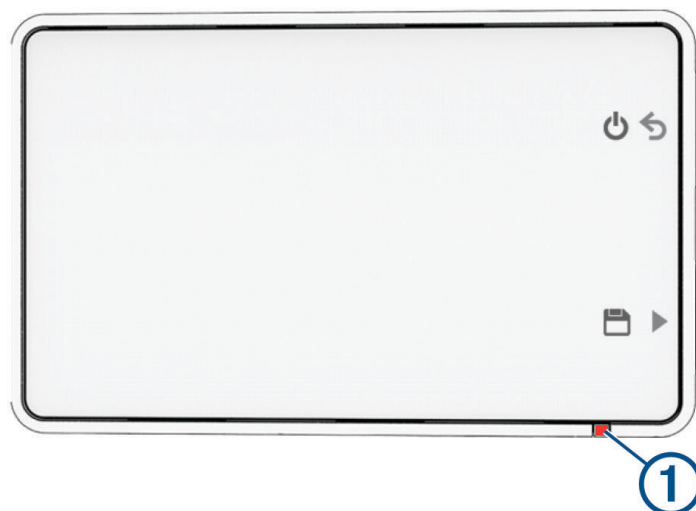

Status LED Activity	Status
Solid red	Video is recording.
Flashing red	A video is being saved. The camera is applying a software update. A Travelapse recording is starting.
Flashing red, slowly	The camera is in Parking Guard mode.
Off	The device is powered off. Videos are being viewed, exported, or deleted, and the camera is not recording video. The device is connected to a computer or a low-power USB port in a vehicle.

Cleaning the Camera Lens

NOTICE

Avoid chemical cleaners and solvents that can damage plastic components.

You should clean the camera lens regularly to improve the quality of recorded video.

- 1 Wipe the lens with a non-scratch lens cloth, optionally dampened with isopropyl alcohol.
- 2 Allow the lens to air dry.

Product Updates

On your computer, install Garmin Express (www.garmin.com/express).

This provides easy access to these services for Garmin devices:

- Software updates
- Product registration

Setting Up Garmin Express

- 1 Connect the device to your computer using a USB cable.
- 2 Go to garmin.com/express.
- 3 Follow the on-screen instructions.

Updating Your Device Using the Garmin Drive App

The Garmin Drive app notifies you when a software update is available for your device. You can also check for updates at any time.

1 From the Garmin Drive app, select your camera.

2 Select **Settings** > **Check for Updates**.

3 Select **Install Now**.

The software update is sent to your device. You are notified when the transfer is complete.

4 Disconnect the device from power until the device turns off.

5 Connect the device to power.

The device installs the software update.

NOTE: Video is not recorded while the software is updating.

Garmin Support Center

Go to support.garmin.com for help and information, such as product manuals, frequently asked questions, videos, and customer support.

Viewing E-Label Regulatory and Compliance Information

1 From the settings menu, scroll to the bottom of the menu.

2 Select **System** > **Regulatory**.

Restarting the Device

You can restart your device if it stops functioning.

Hold the power button for 12 seconds.

Specifications

Operating temperature range	From -20° to 60°C (from -4° to 140°F)
Charging temperature range	From 0° to 60°C (from 32° to 140°F)
Input voltage	From 4.75 to 5.25 Vdc, 1 A
Wireless frequencies	2.4 GHz @ 18.3 dBm maximum 5.1 GHz @ 17.3 dBm maximum 5.7 GHz @ 10.8 dBm maximum
Video codec	HEVC (H.265)

Memory Card Specifications

The camera requires a memory card with these specifications. Go to garmin.com/dashcamcards to view a list of recommended memory cards.

Type	microSDHC or microSDXC
Capacity	From 8 to 512 GB
Speed class	Class 10 or higher
File system	exFAT

Appendix

Constant Power Cable

The Constant Power Cable is an always-on, 12V power adapter that connects to the OBD II port in your vehicle. The device can power up to two dash cameras for a selected length of time after you turn off your vehicle.

For more information, or to purchase a Constant Power Cable, go to garmin.com.

Getting Started

⚠ WARNING

When installing the device in a vehicle, you must install the device securely so it does not interfere with the vehicle operating controls, such as the foot pedals, or the driver's feet. Interference with the vehicle operating controls or feet can result in an accident, which could result in property damage, personal injury, or death.

If you notice any change in engine performance after connecting the device, disconnect the device immediately and contact Garmin product support. Do not use the device if it affects engine performance or acceleration in your particular make and model of vehicle. Issues with engine performance or acceleration could result in an accident, leading to property damage, personal injury, or death.

NOTICE

Defer to your vehicle's warranty provisions and owner's instructions for guidance on whether any OBD II connector product might void or alter your vehicle's warranty. Garmin is not responsible for any costs or expenses associated with vehicle repairs or voided warranties.

Installing the Device

1 Set the time switch (*Time Switch*, page 24).

2 Connect the device to the OBD II port in your vehicle.

The OBD II port is usually located under the dashboard on the driver's side of the vehicle. The OBD II port location may vary depending on the make and model of your vehicle. See your vehicle owner's manual for more information.

3 Remove the protective film from one reclosable fastener, and press the reclosable fastener firmly onto the USB port end of the device for 10 seconds.

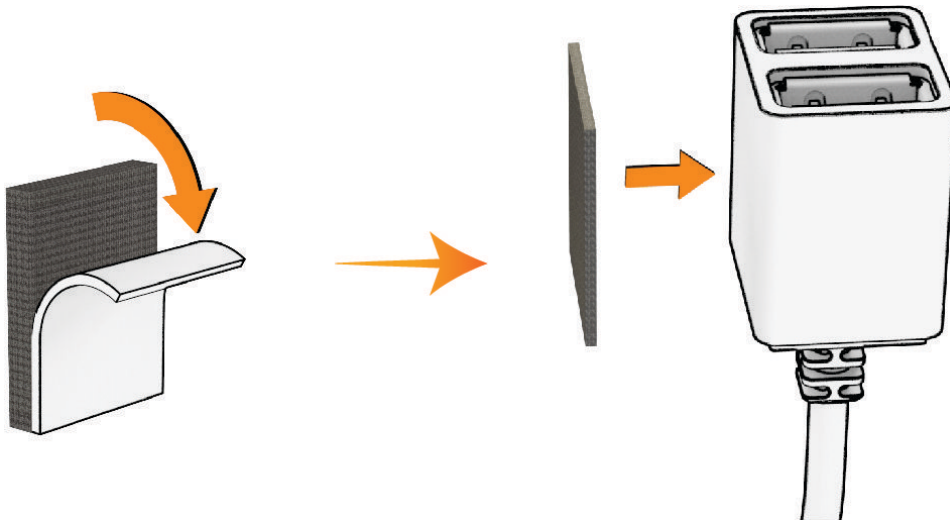

4 Clean the vehicle mounting surface using water or alcohol, and a lint-free cloth.

5 Allow the surface to dry completely.

6 Remove the protective film from a second reclosable fastener, and press it firmly onto the vehicle mounting surface for 10 seconds.

- Press the reclosable fastener on the device against the reclosable fastener on the mounting surface to secure the device to the mounting location.

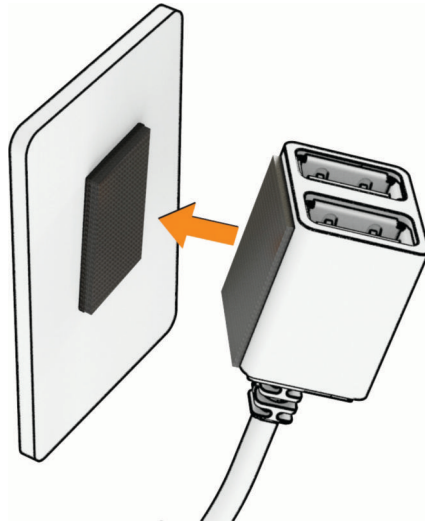

- Connect the USB power cable from your Garmin Dash Cam device to a USB port on the Constant Power Cable device.

Time Switch

The time switch ① sets the length of time the device continues to supply power after you exit the vehicle. The device reenables power when it detects motion, or when you reenter and restart the vehicle.

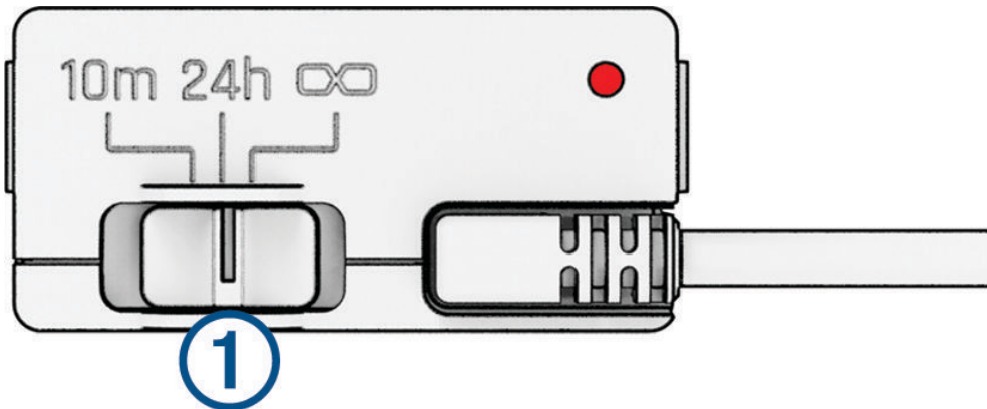

10m	10 minutes
24h	24 hours
∞	Always on

If you want the device to remain off until you reenter the vehicle, you should select the 10m option.

If you want the device to operate continuously while the vehicle is parked, you should select the 24h or ∞ option.

Status LED

The status LED shows the device status.

Status LED Activity	Status
Red	The device is supplying power to the connected devices.
Flashing red	The timer has expired and the device is no longer supplying power to the connected devices.
Off	The device is receiving less than 12 V of power. The low battery protection feature turns off the device to protect the vehicle battery.

Specifications

Operating temperature	From -20° to 45°C (from -4° to 113°F)
Input	From 12 to 16 V, 1.6 A Max.
Output	5 Vdc, 1.5 A each (3.0 A total)
Low battery protection voltage	12 V

Parking Mode Cable

The parking mode cable accessory connects the camera to constant power and allows the camera to record video while the vehicle is parked and turned off.

For more information, or to purchase a parking mode cable, go to garmin.com.

Parking Mode Cable Wiring Diagram



Item	Wire Color	Wire Function
①	Black	Ground
②	Yellow	Battery 12 V
③	Red	Accessory 12 V

Connecting the Parking Mode Cable Accessory to Power

⚠ CAUTION

Garmin strongly recommends having an experienced installer with the proper knowledge of electrical systems install the device. Incorrectly wiring the power cable can result in damage to the vehicle or the battery and can cause bodily injury.

- 1 Route the parking mode cable accessory to a location in the vehicle with constant power, switched power, and a ground connection.
- 2 Connect the **BATT** wire to a constant power source.
- 3 Connect the **ACC** wire to a switched power source.
- 4 Connect the **GND** wire to the bare metal of the vehicle's chassis using an existing bolt or screw.
- 5 Plug the parking mode cable accessory into the USB port on the camera.

Troubleshooting

My camera feels warm while it is operating

Garmin cameras are designed for the automotive environment. It is normal and expected for the products to become warm or hot and remain safe for use in warm climates with full sun exposure. The temperature of the device itself can exceed the specified maximum operating ambient temperature for the device and remain safe for use. Always follow the device use and care instructions contained in the product manual.

My memory card has degraded and needs to be replaced

All microSD[®] memory cards wear out after they are overwritten a large number of times. Periodically formatting the card can extend the useful life and improve performance. Because the dash camera records continuously, you may need to replace the memory card periodically ([Installing a Memory Card, page 2](#)). Your device detects memory card errors automatically and alerts you when it is time to format or replace your memory card.

You can take these actions to help extend the useful life of the memory card.

- Format the memory card at least one time every six months ([Formatting the Memory Card, page 2](#)).
- If the device displays a memory card error alert, first try formatting the memory card ([Formatting the Memory Card, page 2](#)) and then, if necessary, replace the memory card ([Installing a Memory Card, page 2](#)).
- Turn off the device, or ensure the **Parking Guard** feature is enabled when your vehicle is not in use.
If your device is not connected to an ignition-switched vehicle power outlet, you should turn off the device when your vehicle is not in use to prevent the dash camera from recording unneeded footage.
- Use a memory card with a higher storage capacity.
Because higher-capacity memory cards are overwritten less frequently, they usually last longer.
- Use a high-quality memory card with a speed rating of class 10 or higher.
- Purchase your replacement memory card from a high-quality manufacturer and a reputable vendor.

My video recordings are blurry

- Clean the camera lens ([Cleaning the Camera Lens, page 21](#)).
- Clean the windshield in front of the camera.
- Verify the area of the windshield in front of the camera is cleared by the windshield wipers, and move the device, if necessary.

My video recordings are choppy or incomplete

- For the best camera and video results, use a high-quality memory card with a speed rating of class 10 or higher. Go to garmin.com/dashcamcards to view a list of recommended memory cards.
A slower memory card may not record video quickly enough.
- If you are viewing videos on your smartphone using a wireless connection to the camera, try viewing them in another location with less wireless interference, or try transferring videos to the smartphone (*Editing and Exporting a Video*, page 17).
- Transfer important recordings to a computer or smartphone, and format the memory card (*Formatting the Memory Card*, page 2).
- If the device displays a memory card error alert, first try formatting the memory card (*Formatting the Memory Card*, page 2) and then, if necessary, replace the memory card (*Installing a Memory Card*, page 2).
- Update your device to the latest software (*Product Updates*, page 21).

