

mem::rex®

**7-IN-1 NOSTALGIC WOODEN MUSIC CENTER, AM/FM, CD
TURNTABLE, BLUETOOTH, USB PLAYER/RECORDER**

MODEL | **JC-3719AA**

OPERATION MANUAL



ENGLISH

SPECIAL NOTES

For users in U.S.



CAUTION
RISK OF ELECTRIC
SHOCK DO NOT OPEN



CAUTION: TO REDUCE THE RISK OF ELECTRIC SHOCK, DO NOT REMOVE COVER (OR BACK). NO USER-SERVICEABLE PARTS INSIDE. REFER SERVICING TO QUALIFIED SERVICE PERSONNEL.

Explanation of Graphical Symbols:



The lightning flash with arrowhead symbol, within an equilateral triangle, is intended to alert the user to the presence of uninsulated "dangerous voltage" within the product's enclosure that may be of sufficient magnitude to constitute a risk of electric shock to persons.



The exclamation point within an equilateral triangle is intended to alert the user to the presence of important operating and maintenance (servicing) instructions in the literature accompanying the appliance.

WARNING: TO REDUCE THE RISK OF FIRE OR ELECTRIC SHOCK, DO NOT EXPOSE THIS APPLIANCE TO RAIN OR MOISTURE.

FOR YOUR RECORDS

For your assistance in reporting this unit in case of loss or theft, please record below the model number and serial number which are located at the bottom of the unit.

Please retain this information.

Model number _____

Serial number _____

Date of purchase _____

Place of purchase _____

To obtain service or product
information,
call **1-877-506-4900**

FCC COMPLIANCE STATEMENT

This equipment has been tested and found to comply with the limits for a Class B digital device, pursuant to part 15 of the FCC Rules. These limits are designed to provide reasonable protection against harmful interference in a residential installation. This equipment generates, uses and can radiate radio frequency energy and, if not installed and used in accordance with the instructions, may cause harmful interference to radio communications. However, there is no guarantee that interference will not occur in a particular installation. If this equipment does cause harmful interference to radio or television reception, which can be determined by turning the equipment off and on, the user is encouraged to try to correct the interference by one or more of the following measures:

Reorient or relocate the receiving antenna. Increase the separation between the equipment and receiver.

Connect the equipment into an outlet on a circuit different from that to which the receiver is connected. Consult the dealer or an experienced radio/TV technician for help.

CAUTION: To reduce the risk of electric shock, do not remove cover (or back). No userserviceable parts inside. Refer servicing to qualified service.

FCC NOTICE:

This device complies with Part 15 of the FCC Rules. Operation is subject to the following two conditions: (1) this device may not cause harmful interference, and (2) this device must accept any interference received, including that may cause undesired operation.

FCC Radiation Exposure Statement:

The product comply with the US portable RF exposure limit set forth for an uncontrolled environment and are safe for intended operation as described in this manual. The further RF exposure reduction can be achieved if the product can be kept as far as possible from the user body or set the device to lower output power if such function is available. This transmitter must not be co-located or operating in conjunction with any other antenna or transmitter.

Any changes or modifications to this unit not expressly approved by the party responsible for compliance could void the user's authority to operate the equipment.

SAFETY INSTRUCTIONS

1. **Read Instructions:** All the safety and operating instructions should be read before the appliance is operated.
2. **Retain Instructions:** The safety and operating instructions should be well kept for future reference.
3. **Heed Warnings:** All warnings on the appliance and in the operating instructions should be adhered to.
4. **Follow Instructions:** All operating and use instructions should be followed.
5. **Power Sources:** The appliance should be connected to a power supply only of the type described in the operating instructions or as marked on the appliance.
6. **Power-Cord Protection:** Power supply cords should be routed so that they are not likely to be walked on or pinched by items placed upon or against them, paying particular attention to cords at plugs, convenience receptacles, and the point at which they exit from the appliance.
7. **Overloading:** Do not overload wall outlets and extension cords as this can result in a risk of fire or electric shock.
8. **Grounding or Polarization:** Precaution should be taken to insure that the grounding or polarization means of an appliance is not defeated.
9. **Severe weather:** In extreme weather such as lightning storm, hurricane, unplug it from the wall outlet and disconnect the antenna or cable system. This will prevent damage to the appliance due to unexpected power surges.
10. **Water and Moisture:** The appliance should not be used near water-for example, near a bathtub, washbowl, kitchen sink, laundry tub, swimming pool, or a wet basement.
11. **Heat:** The appliance should be situated away from heat sources such as radiators, heat registers, stoves, or other appliances (including amplifiers) that produce heat.
12. **Object/Liquid Entry:** Care should be taken so that no object/liquid enter into the enclosure through openings.
13. **Ventilation:** The appliance should not be situated so that its location (on a bed, sofa, rug, or similar surface) or position (such as a bookcase or cabinet) interferes with its proper ventilation.
14. **Mounting:** The appliance should be mounted only as recommended by the manufacturer.
15. **Cleaning:** Only use a soft dry cloth to clean the appliance.
16. **Servicing:** The user should not attempt to service the appliance beyond that described in the user's operating instructions. All other servicing should be referred to qualified personnel.
17. **Replacement Parts:** When replacement parts are required, be sure the service technician has used replacement parts specified by the manufacturer. Unauthorized substitutions may result in fire, electric shock or other hazards.
18. **Damage Requiring Service:** The appliance should be serviced by qualified service personnel when:
 - The power-supply cord or plug has been damaged.
 - Objects have fallen into, or liquid has been spilled into the appliance enclosure.
 - The appliance has been exposed to rain.
 - The appliance has been dropped, or the enclosure damaged.
 - The appliance does not appear to operate normally or exhibits a marked change in performance.
19. **Carts and Stands:** An appliance and cart combination should be moved with care. Quick stops, excessive force, and uneven surfaces cause the appliance and cart combination to overturn.
20. **Non-use Periods:** The power cord of the appliance should be unplugged from the outlet/The batteries should be removed when the appliance is to be left unused for a long period of time.



FEATURES

The 7 in 1 Nostalgic Wooden Music Center features a great retro design and solid wood construction. With a 3 Speed turntable, CD & Cassette Player the Monument is ready to play all your music! The Dual Bluetooth feature allows streaming of your music to an external speaker. Record and playback all your favorite songs with the built in USB player & recorder. Also features built in Speakers & AM/FM Radio.

- 3-Speed record player with Auto Return will play 33 1/3, 45, 78 rpm records
- Bluetooth In connectivity allows you to stream music from another source up to 33 feet away.
- Bluetooth Out Connectivity allows you to stream vinyl playback through any external Bluetooth Speaker
- CD & Cassette Player and AM/FM Radio
- USB Input for Playback & One Touch Recording of your favorite Music
- Built in Stereo Speakers for playback convenience
- Includes a 3.5mm Aux input for additional connectivity options

SPECIFICATIONS

Turntable Speed	33 1/3, 45, 78 RPM
FM Frequency Range	87.5 - 108 MHz
FM Station Memory	Up to 20
AM Frequency Range	520 - 1710KHz
AM Station Memory	Up to 20
Bluetooth® Version	V5.1
Bluetooth® Transmission Distance	Up to 33 feet (10 Meters)*
Rated Frequency	2.4GHz
Input	Aux In, USB
Output	Line Out
Built-in Speakers	3" x 2
Power Output	10W x 2
Power Source	AC/DC 100-240V 50-60Hz 9V/1.3A
Accessories Included	45 RPM Adaptor, Aux In Cable, Power Adaptor, User Manual

* Distance may vary depending on any objects or interference between devices.

**SPECIFICATIONS AND ACCESSORIES ARE SUBJECT TO CHANGE
WITHOUT NOTICE**

PRODUCT OVERVIEW

Turntable

1. Turntable Platter
2. Turntable Spindle
3. Lift Lever
4. Speed Indicator
5. Speed Selector
6. Tone Arm

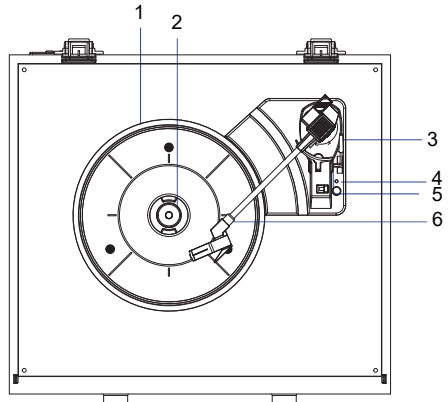

Front Panel

1. USB Port
2. CD Door
3. AUX IN Jack
4. Power Button
5. Function Knob
6. Repeat/ Scan Button
7. Open/Close
8. Record/Erase Button
9. Rewind / Previous Button
10. FM/AM Button
11. Display
12. USB/MP3/DISC/FOLDER Up/Down Button
13. Fast Forward / Next Button
14. Stop / Pair Button
15. Program / Memory Button
16. PL/PA/BT OUT/OK Button
17. Volume +/- Knob

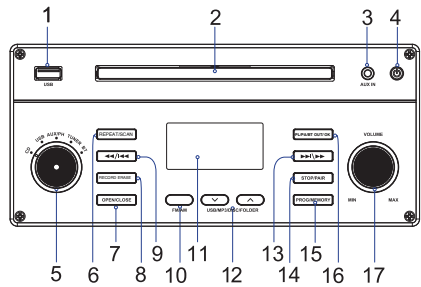

Back Panel

1. FM Antenna

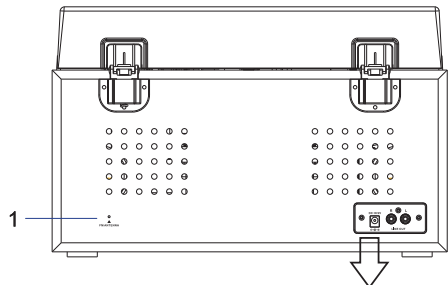

Side Panel



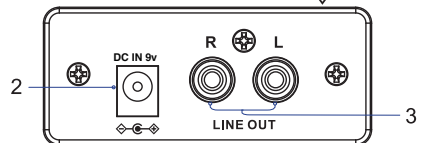

2. DC IN Jack
3. Line Out Jack



Essential Setup

1. Unpack the unit and remove all packaging materials.
2. Place the unit on a flat and level surface. The selected location should be stable and free from vibration.
3. Plug the power adaptor into the electrical outlet and connect other end to the back of the unit.
4. Press the  Button on the upper right corner of the front panel. The Display will light up in amber background, and the playback mode will appear on the display.
5. When the unit is playing music, the playback message will appear on the display.

Common playback control

- Press the PL/PA/BT OUT/OK Button to pause / play the playback.
- Press the  or  button to skip to next or previous track.
- To search for a part of track: press and hold the  or  button and release it when the part you want is found.
- Search for a folder, press the USB/MP3/DISC/FOLDER Up/Down Button to choose the folder.
- Press the STOP/PAIR button to stop playing.

Note: These controls do NOT always function in specified playback mode.



Repeat function

- Press REPEAT button:
- one time, to repeat the current track.
 - two times, to repeat the current folder.
 - three times, to repeat all tracks of the disc.
 - four times, to cancel the repeat function.

Note: This feature functions in CD and USB mode.

Program function

This function enables you to set the playback of tracks into an ordered playlist.

1. Press the STOP button; then press the **PROG/MEMORY** Button to activate the program feature. The display will show "MEMORY", "P01" and blinking "00".
2. Press the  or  button to select your track.
3. Press the **PROG/MEMORY** button again to confirm.
4. Repeat the above steps to program other tracks.
5. After finished, press the **PL/PA/BT OUT/OK** button to start playback.
6. Press the **STOP/PAIR** button once to stop.
7. Press the **STOP/PAIR** button twice to erase the programmed track, and "MEMORY" will disappear from the display.

Note:

- This feature functions in CD and USB mode.
- This unit can program up to 20 tracks.
- Turning the power off or switching to other playback modes by turning the Function Knob will automatically erase the programmed playlist.

RADIO OPERATION

1. Set the Function Knob to **TUNER** position.



2. Press the **AM/FM** button to receive AM or FM signals. Note to extend the FM antennae when you want to listen to FM stations.
3. Press and hold the **◀◀/▶▶** or **▶▶/◀◀** button to search for available stations.
4. Adjust the volume by rotating the VOLUME +/- knob.
5. You can store your favorite station to the unit and listen it conveniently by following steps:
 - a. When you are listening to a radio channel, press PROG/MEMORY button, "MEMORY" will appear and blink on the display.
 - b. Press **1** or **2** button to select a number as the serial number of the current channel.
 - c. Press PROG/MEMORY button again to confirm.
 - d. Repeat the a-c steps to store other your favorite radio channels.
 - e. To listen the stored radio channels, just press PROG/MEMORY button, then use **1** or **2** button to select the serial number of your favorite radio channel, press PROG/MEMORY button again to confirm. Then the selected channel starts to play.

You can improve the signal receiving strength by:

- Extending the FM Antenna to a higher position.
- Turn the unit to face different directions.
- Move the unit to a different place.
- Connect the FM Antenna to your outdoor antenna.

CD OPERATION

1. Set the Function Knob to **CD** position.



2. Press the **OPEN/CLOSE** button to open the disc tray.
3. Place your desired audio CD on the tray with its label side up.
4. Press the **OPEN/CLOSE** button to close the tray.
5. The CD will start to play automatically.

Note:

- Do not pull or push the disc tray manually.
- Ensure the disc is placed in the center of the disc tray with its label side up.
- Be sure the inserted disc is an Audio CD / MP3 CD, not DVD or any other type of disc.

AUX IN OPERATION

1. Insert one end of the 3.5mm AUX in cable into the AUX IN Jack on the upper right of the front control panel, the other end to your playing device.

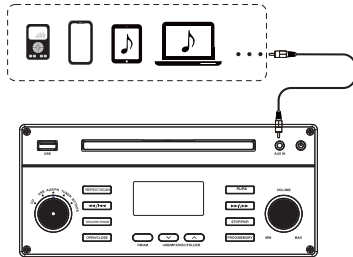

2. Set the Function Knob to **AUX/PH** position.



3. Start to play your favorite music on your playing device.

USB OPERATION

1. Set the Function Knob to **USB** position.



2. Insert a USB device (only with .mp3 audio files) to the USB Port.
3. The unit will start playback automatically.
4. Use the volume and control buttons to control playback.

Note: control buttons may not work with all USB devices due to manufacturing differences.

Recording with USB

With this function you can record music from your player onto a USB device in .mp3 format.

1. Insert a USB device into the USB port.
2. Play music in the CD, AUX, Phono, BT or Tape mode.
3. Press the **RECORD/ERASE** button repeatedly until **•USB REC** starts blinks in the lower left corner of the display (the information on the display varies with the playback mode when **RECORD/ERASE** button is pressed each time). Now the recording process starts.

4. Press the **STOP/PAIR** button to stop recording, and "END-REC" will appear on display. Now the recording process ends.

Note: If you want to listen the latest record track, just press **◀◀/▶▶** button if it does not start to play automatically.

Erasing Files on the USB Device

1. Insert a USB device into the USB port and play the song you want to delete.
2. Press and hold the **RECORD/ERASE** button for about two seconds, "ERA" with blinking, and "ONE" will appear on the display.
3. Press the **◀◀/▶▶** or **▶▶/◀◀** button to select:
 - a. ERA ONE - erase the current track
 - b. ERA FOLD - erase all the audio tracks in the entire folder
 - c. ERA ALL - erase all the audio tracks on the USB device
4. Press the **RECORD/ERASE** button again to confirm. "ERA WAIT" will appear, and erasing process starts.
5. When all tracks and folders erased, "NO SONG" will be shown on display.

VINYL RECORD OPERATION

1. Press the Power Button to turn on the unit and open the cover.
2. Set the Function Knob to "AUX/PH" position.



3. Detach the stylus protector by pressing both sides and pulling straight in the direction shown.

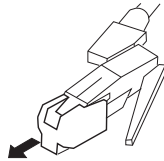

4. Place a vinyl record on the Turntable by aligning the Turntable Spindle to the record hole.
5. Slide the Speed Selector to 33, 45 or 78 to match the play speed of the record.
6. Unlock the Hold Down Clip.

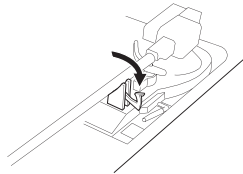

7. Raise the Cue Lever to lift the Tonearm off the Tonearm support.
8. Gently move the Tonearm to the edge of the record (or the starting point of a track).
9. Release the Cue Lever to put the Tonearm onto the record. Turntable will begin playback. Then the panel will show "PHONO" and the related speed.
10. Turn the VOLUME +/- Tuner to adjust the volume. To pause/stop during playback, raise the Cue Lever to lift the Tonearm off the record.
11. When finished listening, the Cue Arm will return to the support automatically. What you have to do is lock the Hold Down Clip.

Note:

- Pull out the Aux in cable before playing a vinyl, or the unit will switch to AUX mode automatically.
- Put the 45 RPM Adapter across the Turntable Spindle firstly if playing a 45 RPM record.
- After you play 78 RPM vinyl record, it will stop in about 120 seconds.

With the Bluetooth® In function, you can play music from an external Bluetooth® device on the speakers of this unit.

1. Set the Function Knob to **BT/TAPE** position. “BT” will blink on display.



2. Turn on your external Bluetooth device and pair with the “**MX-TT700**” device.
3. When the Bluetooth connection is established, you will hear a short confirmation sound from the unit, and “BT” will stop blinking on the display.
4. Start to play your favorite music on the connected device.

Note: Make sure the cassette tape not inserted in the unit, or it will be TAPE mode.

Bluetooth® Transmitter

You can play music from this unit on external Bluetooth® speakers, soundbar, earbuds, or headphones.

1. Disable the Bluetooth® function on all devices nearby (e.g. amplifier, soundbar, wireless headphone, smart phone, iPad).
2. Play music in the CD, AUX, Phono, USB, Tuner, or Tape mode.
3. Press the **PL/PA/BT OUT/OK** Button to activate Bluetooth Transmitter function.
4. Power on your Bluetooth® speakers or headphones and activate its Bluetooth pairing mode.
5. After a few seconds, a beep will be heard, which means your turntable will connect automatically.
6. To select desire Bluetooth, press the previous or next button and press the **PL/PA/BT OUT/OK** button .To change volume playback, turn the volume knob on the unit or adjust the volume on your Bluetooth® device.
7. To turn off BT OUT mode, press and hold the **PL/PA/BT OUT/OK** Button again.

Bluetooth® Scan

1. Disable the Bluetooth® function on all devices nearby (e.g. amplifier, soundbar, wireless headphone, smart phone, iPad).
2. Play music in the CD, AUX, Phono, USB, Tuner, or Tape mode.
3. Press and hold the **Repeat/ Scan** Button to activate Bluetooth Scan function.
4. Power on your Bluetooth® speakers or headphones and activate its Bluetooth pairing mode. After a few seconds, a beep will be heard, which means your turntable will connect automatically.
5. To select desire Bluetooth, press the Previous or Next button and press the **PL/PA/BT OUT/OK** button. To change volume playback, turn the volume knob on the unit or adjust the volume on your Bluetooth® device.

CARE & MAINTENANCE

Always keep the turntable clean. If the surface of the unit gets dirty, wipe with a soft dry cloth or use a diluted mild liquid soap. Be sure to remove any excess liquid completely. Do not use thinner, benzene or alcohol as they may damage the surface of the unit. Allow the surface of the unit to dry completely before using.

Beware of condensation

When the unit (or a record/disc) is moved from a cold to warm place, or used after a sudden temperature change, condensation may form; vapor in the air could condense on the internal mechanism, making correct operation erratic or impossible. To prevent this, or if this occurs, leave the unit turned off for one or two hours. The unit will stabilize at the temperature of its surroundings.

Using Compact Discs

Discs which can be played on this unit:

- Conventional audio CD
- Properly finalized CD-R and CD-RW discs
- Always place the disc on the disc tray with the label side up. (Compact discs can be played or recorded only on one side.)
- To remove a disc from its storage case, press down on the center of the case and lift the disc out, holding it carefully by the edges. Should the disc become dirty, wipe the surface radially (from the center hole outward towards the outer edge) with a soft, dry cloth.



How to remove the disc



How to hold the disc



How to clean the disc

- Never use such chemicals as record sprays, antistatic sprays or fluid, benzene or thinner to clean the discs. Such chemicals will do irreparable damage to the disc's plastic surface.
- Discs should be returned to their cases after use to avoid dust and scratches that could cause the laser pickup to "skip."
- Do not expose discs to direct sunlight or high humidity and temperature for extended periods. Long exposure to high temperatures will warp the disc.
- Do not play any disc that is warped, deformed or damaged. Playing such discs may cause irreparable harm to the playing mechanisms.
- CD-R and CD-RW discs are more sensitive to the effects of heat and ultraviolet rays than ordinary CDs. It is important that they are not stored in a location where direct sunlight will fall on them, and away from sources of heat such as radiators or heat-generating electrical devices.
- Printable CD-R and CD-RW discs are not recommended, as the label side might be sticky and damage the unit.
- Do not stick papers or protective sheets on the discs and do not use any protective coating spray.
- Use a soft oil-based felt-tipped pen to write the information on the label side. Never use a ball-point or hard-tipped pen, as this may cause damage to the recorded side.
- Never use a stabilizer. Using commercially available CD stabilizers with this unit will damage the mechanisms and cause them to malfunction.
- Do not use CDs with an irregular shape (octagonal, heart shaped, business card size, etc.). CDs of this sort can damage the unit:



- If you are in any doubt as to the care and handling of a CD-R/CD-RW disc, read the precautions supplied with the disc, or contact the disc manufacturer directly.

Head Maintenance

The head and tape path should be cleaned and demagnetized periodically. Please use a cassette type head cleaning tape and demagnetizer. For specific details on the proper use of either item, please read each item's instruction manual.

Maintaining Vinyl Records

- Do not touch the record's grooves. Only handle records by edges or label.
- Make sure your hands are clean. Skin oils from even clean hands can leave a residue on the record surface that will gradually deteriorate the quality of your record.
- Keep your records away from dust. Store in a cool, dry place.
- Keep records in sleeves and jackets when not in use to avoid dust and scratches.
- Store records upright on edges. Records stored horizontally will bend and warp.
- Do not expose records to direct sunlight or high humidity and temperature. Long exposure to high temperatures will warp records.
- Do not store records in the trunk of a car.
- Store records in an area with a stable temperature and low humidity.
- Should the record become dirty, gently wipe surface in a circular motion, using a soft anti-static cloth.

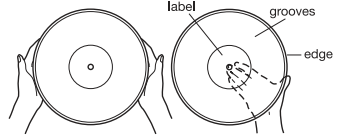

How to Replace the Stylus

The stylus should last about 50 hours under normal use. However, it is recommended that the stylus be replaced as soon as you notice a change in sound quality. Prolonged use of a worn-out stylus may damage the record. Wear and tear on the stylus will be accelerated when playing 78 RPM records. The higher speed of 78 RPM records can wear the stylus more quickly.

Caution:

- Do not bend the stylus.
- To avoid injury, do not touch the needle.
- Turn off the unit's power before you replace the stylus.
- Keep out of the reach of children.

CARE & MAINTENANCE

- Handle with care, as the stylus is delicate. Use of a bent or broken stylus may damage the record and cause the turntable to malfunction.
- Do not expose stylus to extreme heat.
- Contact a qualified repair company if you experience difficulty in changing the stylus.

Removing an Old Stylus

1. Set a screwdriver at the tip of the stylus and push down to the direction "A".
2. Pull the stylus out toward direction "B".

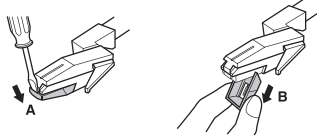

Installing a New Stylus

1. Hold the tip of the stylus and insert the other edge by pressing toward direction "C".
2. Push the stylus up toward direction "D" until it locks at the tip.

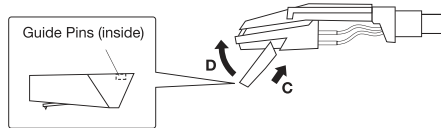

TROUBLESHOOTING GUIDE

In case of trouble with the unit, please look through the problems below and see if you can solve them yourself before calling your dealer.

Function	Problem	Solution
General	No power	<ul style="list-style-type: none"> • Check the connection to the AC power source. Make sure the AC source is not a switched outlet and if it is, turn the switch on. Make sure there is power to the AC outlet by plugging another item such as a lamp or fan.
	No sound	<ul style="list-style-type: none"> • Adjust the volume • Connect the AUX IN cables into the correct jack.
	The sound has interference	<ul style="list-style-type: none"> • The unit is too close to a TV set or similar appliance. Relocate the unit further away from them or turn the other appliances off.
Radio	Cannot listen to any station or signal is weak	<ul style="list-style-type: none"> • Tune in the station properly. • If a TV is near the unit, turn it off. • Rotate the unit or antenna wire for the best reception position.
Record Player	Will not play	<ul style="list-style-type: none"> • Turn the VOLUME KNOB clockwise. • Loosen the screw and detach the stylus guard. The stylus guard is a white plastic cover that protects the stylus during transportation. Failing to remove this guard will not allow the needle to contact the grooves of the record and no sound will be heard! • If the stylus is worn-out, change the stylus. Select the correct playback speed.
	Sound skips	<ul style="list-style-type: none"> • Place the unit on a stable surface to avoid vibration and shock. Make sure the unit is level both front to back and side to side. • Clean the surface of the record/disc. • Do not use scratched, damaged or warped records/discs.
CD Player	Will not play	<ul style="list-style-type: none"> • Turn the VOLUME knob clockwise and rotate the FUNCTION KNOB to "CD". • Load a disc with the playback side facing down. • If the disc is dirty, clean the surface of the disc. • A blank disc has been loaded. Load a pre-recorded disc. • Depending on the disc, it may not be possible to play back CD-R/CD-RW discs. Try again with another disc. • You cannot play back unfinalized CD-R/CD-RW discs. Finalize and try again.
Bluetooth®	Will not play	<ul style="list-style-type: none"> • Device is NOT paired properly; turn OFF Bluetooth, turn ON Bluetooth and repair device.
AUX In	No Sound	<ul style="list-style-type: none"> • Ensure external player works when not connected via AUX cable. • Ensure AUX In cables are securely connected and not damaged. • Increase the volume level.





Accessories :

AC adaptor,

45 RPM adapter,

Aux in cable,

Instruction Manual

	The symbol indicates AC voltage
	The symbol indicates DC voltage
	For indoor use only
	The symbol indicates energy efficiency marking
	The symbol indicates polarity of d.c. power connector

mem:rex®