

AZIO

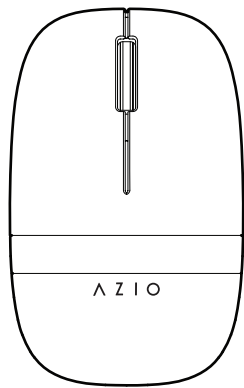

IZO

WIRELESS MOUSE

USER GUIDE ENGLISH

AZIO_IZO_MS_UG_V01

SAFETY WARNING & CERTIFICATION

FCC STATEMENT

Changes or modifications not expressly approved by the party responsible for compliance could void the user's authority to operate the equipment. This equipment has been tested and found to comply with the limits for a Class B digital device, pursuant to Part 15 of the FCC Rules. These limits are designed to provide reasonable protection against harmful interference in a residential installation. This equipment generates, uses and can radiate radio frequency energy and, if not installed and used in accordance with the Instructions, may cause harmful interference to radio communications. However, there is no guarantee that interference will not occur in a particular installation. If this equipment does cause harmful interference to radio or television reception, which can be determined by turning the equipment off and on, the user is encouraged to try to correct the interference by one or more of the following measures:

- Reorient or relocate the receiving antenna.
- Increase the separation between the equipment and receiver.
- Connect the equipment into an outlet on a circuit different from that to which the receiver is connected.
- Consult the dealer or an experienced radio/TV technician for help

This device complies with part 15 of the FCC rules. Operation is subject to the following two conditions (1) this device may not cause harmful interference, and (2) this device must accept any interference received, including interference that may cause undesired operation.

BATTERY WARNING

THE AZIO IZO mouse contains a Li-ion rechargeable battery. The general life expectancy of the batteries used are based on actual usage. If you suspect the battery's contained power is low, please use the included USB connection cable to recharge the battery.

Caution:

Please do not open, manipulate, or expose to conducting materials (metal), moisture, liquid, fire, or heat. Conducting any of above action may cause batteries to leak or explode, resulting in personal injury. Please do not leave the rechargeable battery discharged or unused for extended period, which might affect the life usage of the battery.

CA PROP 65 WARNING

This product contains chemicals known to the state of California to cause cancer, and birth defects or other reproductive harm. For more information go to www.P65Warnings.ca.gov

CE STATEMENT OF COMPLIANCE WITH EU DIRECTIVE

AZIO CORPORATION declares that the IZO Mouse is in compliance with the essential requirements and other relevant provisions of Directive 2014/53/EU.

The full Declaration of Conformity can be requested via the following:

Company: AZIO CORPORATION
Address: 19933 Harrison Ave, City of Industry, California 91789
E-mail: support@aziocorp.com

SUPPORT & WARRANTY

Here's How to Reach Us

By phone: 866.468.1198
By email: support@aziocorp.com
On FB: www.facebook.com/aziocorp



Multilingual instruction guide is available for download at www.aziocorp.com > Support > Mice > IZO Mouse

AZIO Corporation warrants only to the original purchaser of this product, when purchased from an AZIO authorized reseller or distributor, that this product will be free from defects in material and workmanship under normal use and service for the length of the warranty period after purchase. AZIO reserves the right, before having any obligation under this warranty, to inspect the damaged AZIO product. Initial shipping costs of sending the AZIO product to the AZIO service center in Los Angeles, California, for inspection shall be borne solely by the purchaser. In order to keep this warranty in effect, the product must not have been mishandled or misused in any way.

This warranty does not cover any damage due to accidents, misuse, abuse or negligence. Please retain the dated sales receipt as evidence of the original purchaser & date of purchase. You will need it for any warranty services. In order to claim under this warranty, purchaser must contact AZIO and obtain an RMA # which is to be used within 15 days of issuance and must present acceptable proof of original ownership (such as original receipt) for the product. AZIO, at its discretion, shall repair or replace the defective unit covered by this warranty. This warranty is non-transferable and does not apply to any purchaser who bought the product from a reseller or distributor not authorized by AZIO, including but not limited to purchases from internet auction sites. This warranty does not affect any other legal rights you may have by operation of the law. Please contact AZIO through email, chat, or one of the technical support numbers listed for warranty service procedures.

No AZIO supplier, dealer, agent, or employee is authorized to alter or extend the terms of this Limited Warranty or to make any representation whatsoever. AZIO reserves the right to amend the terms of this Limited Warranty at any time without notice.

HELP RESOURCES

Before lodging a claim on the Limited Warranty, please review the online help resources at aziocorp.com/support. If the product is still not functioning properly after making use of these resources, please contact AZIO through aziocorp.com/support or your authorized distributor or dealer. You may be required to assist with the diagnosis process to verify and ascertain any issues which you may be facing with the product. Service options, parts availability, and response times may vary depending on the country in which the Limited Warranty claim is lodged.

WASTE ELECTRICAL & ELECTRONIC EQUIPMENT INFORMATION

Correct Disposal of This Product (Waste Electrical & Electronic Equipment)
[Applicable in the European Union and other European countries with separate collection systems]
This marking shown on the product or its literature, indicates that it should not be disposed with other household wastes at the end of its working life. To prevent possible harm to the environment or human health from uncontrolled waste disposal, please separate this from other types of wastes and recycle it responsibly to promote the sustainable reuse of material resources. Household users should contact either the retailer where they purchased this product, or their local government office, for details of where and how they can take this item for environmentally safe recycling. Business users should contact their supplier and check the terms and conditions of the purchase contract. This product should not be mixed with other commercial wastes for disposal.

IMPORTANT PRODUCT INFORMATION GUIDE

SAFETY GUIDELINES

In order to have maximum safety while using this product, we strongly suggest that you adopt the following guidelines:

1. Should you have trouble operating the device properly and troubleshooting does not work, please unplug the device and contact the AZIO support or go to www.aziocorp.com for support. Do not attempt to service or fix the device yourself at any time.
2. Do not disassemble the device (doing so will void your warranty) and do not attempt to operate it under abnormal current loads.
3. Keep the device away from liquid, humidity or moisture. Operate the device only within the specific temperature range of 0°C (32°F) to 40°C (104°F). Should the temperature exceed this range, unplug and /or switch off the device in order to let the temperature stabilize to an optimal level.

COMFORT

Research has shown that long periods of repetitive motion, improper positioning of your computer peripherals, incorrect body position, and poor habits may be associated with physical discomfort and injury to nerves, tendons, and muscles. Below are some guidelines to avoid injury and ensure optimum comfort while using your AZIO IZO.

1. Position your keyboard and monitor directly in front of you with your mouse next to it. Place your elbows next to your side, not too far away and your mouse within easy reach.
2. Adjust the height of your chair and table so that the keyboard and mouse are at or below elbow height.
3. Keep your feet well supported, posture straight and your shoulders relaxed.
4. During usage, relax your wrist and keep it straight. If you do the same tasks with your hands repeatedly, try not to bend, extend or twist your hands for long periods.
5. Do not rest your wrists on hard surfaces for long periods. Use a wrist rest to support your wrist while gaming.
6. Customize the keys on your keyboard to suit your style of usage in order to minimize repetitive or awkward motions.
7. Do not sit in the same position all day. Get up, step away from your desk and do exercises to stretch your arms, shoulders, neck and legs.
8. If you should experience any physical discomfort while using your numpad, such as pain, numbness, or tingling in your hands, wrists, elbows, shoulders, neck or back, please consult a qualified medical doctor immediately.

MAINTENANCE & USE

For the metal and plastic parts of the mouse, once a month we recommend you unplug the device from the computer and clean it using a soft cloth or cotton swab with a bit of warm water to prevent dirt buildup. Please do not use soap or harsh cleaning agents. Remember to dry off any left over moisture on the metal parts of the mouse.

We are dedicated to provide our products with premium materials and present them in the best condition, but consistent care will keep the product at its optimum over a longer duration.

HOW TO MAKE A LIMITED WARRANTY CLAIM

If you purchased the product from an AZIO reseller, please contact the AZIO reseller in regards to your Limited Warranty claim.

If you are unable to return the product to the AZIO reseller for whatever reason, or if you have purchased the product directly from AZIO at aziocorp.com, then please follow the steps below:

- a. Email support@aziocorp.com to obtain a Return Merchandise Authorization Number ("RMA Number").
- b. Note the RMA Number in a visible place on the in the shipping box or write it on the shipping box.
- c. Enclose a Valid Proof of Purchase inside the product's package. Please visit aziocorp.com/warranty for examples of a Valid Proof of Purchase.
- d. Send the product to the following address:

AZIO RMA
19933 Harrison Ave,
City of Industry, California 91789

Do not send AZIO any product without a valid RMA Number.

We advise that you select a method of shipping that is traceable (e.g. UPS, DHL FedEx). Any expense of claiming under this Limited Warranty will be borne by the person making the claim (including any shipping and handling charges in returning the product to AZIO, as well as any applicable customs, duties or taxes in relation to the claim). If the product is validly returned under the terms of this Limited Warranty, AZIO will be responsible for postage expenses for shipping the product back to you (but not any customs charges, duties, or taxes). You are responsible for ensuring that the product is properly packaged and will bear the full risk of loss or damage for any product that is returned improperly packaged. Risk of loss or damage in the returned product only passes to AZIO when the product is received by AZIO and AZIO shall not be responsible for items lost in transit to our address. In the event that the procedure herein is not followed, AZIO reserves the right to accept the delivery of the product on such terms that it may determine at its sole discretion.

Returns Not Covered by this Limited Warranty.

If AZIO receives a product from the purchaser that does not meet the requirements of this Limited Warranty, including (but not limited to) a product that (a) lacks a valid RMA Number, (b) is not accompanied by a valid Proof of Purchase, (c) is no longer covered under the Warranty Period, or (d) does not have a defect covered by this Limited Warranty, you may be responsible for an assessment fee, return shipping and handling fees, and other reasonable fees as may be required by AZIO prior to the product being returned to you.

General.

This Limited Warranty applies only to the original purchaser of the product and is non-transferable. No AZIO reseller, agent, distributor, or employee is authorized to make any modification, extension or addition to this held to be illegal or unenforceable the legality or enforceability of the remaining terms shall not be affected or impaired.

PACKAGE CONTENTS & SPECS

PACKAGE CONTENTS

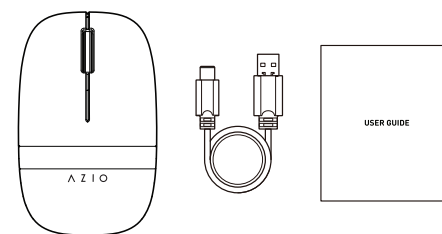

SPECIFICATIONS

Interface	Bluetooth 3.0 & 5.0 + 2.4G RF-USB
Sensor	PixArt PAW3212 [Optical]
Hand Orientation	Ambidextrous
Number of Buttons	3
DPI	1000, 1600, 2400
Battery	1000 mAh Li-ion
Charging Connection	USB Type-C Cable
Dimens. (LxWxH)	104 x 64 x 39 mm
Weight	0.2 lbs / 87.6 g

System Requirements	Windows 8 & above / macOS USB Port or Bluetooth
---------------------	--

Package Contents	IZO Wireless Mouse USB Type-C Cable USB-RF Receiver User Guide
------------------	---

MOUSE SETUP

Mouse Modes & Switches

The AZIO IZO mouse can be connected wirelessly via Bluetooth or via USB-RF receiver. The interface mode switches are located at the bottom of the mouse. (Fig 01)

Fig. 01 / Mouse Switch

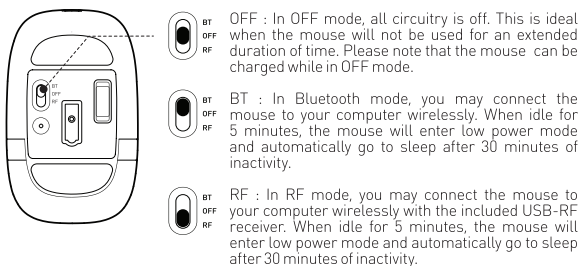

Pairing the Mouse in Bluetooth Mode

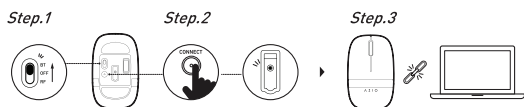

Step.1 Turn on the power switch to **BT Mode**. The mode switch is located on the backside of the mouse.

Step.2 Hold down the **'Connect'** button for a few seconds and release. The blue LED light on the sensor will start to flash while the mouse is searching for a connection. The mouse is now in **Pairing Mode**. (Fig 02)

Step.3 For Mac, navigate to 'System Preferences' and select 'Mouse'. Next, click on 'Set Up Bluetooth Mouse'. For Windows, go to 'Bluetooth Settings' and select 'Add Bluetooth or other device'.

There will be 2 Bluetooth connections available to connect with if you'd like to connect with BT3.0 find "IZO_MS3_X.X" or if you'd like to connect with BT5.0 find "IZO_MS5_X.X" and click "Pair" on the setup wizard. Once pairing is successfully completed, the mouse is ready for use. Once you've paired with two devices, you may switch the active connection between the two devices at any time.

Connecting the Mouse in RF Mode

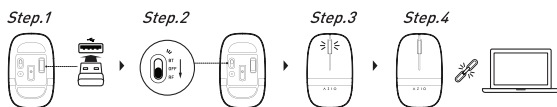

Step.1 Remove the **USB-RF receiver** and connect it to an available USB port on your computer. (Fig 03)

Step.2 Turn on the power switch to **RF Mode**. The mode switch is located on the backside of the mouse.

Step.3 The indicator light on the mouse wheel will **flash green 3 times**, indicating that the mouse is entering RF mode.

Step.4 The AZIO IZO mouse will be connected to your device within 20 seconds and is ready for use.

Re-Pairing the USB RF Dongle to the Mouse

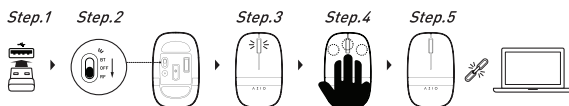

Step.1 Please insert the **USB-RF receiver** to your computer's USB port.

Step.2 Turn on the power switch to **RF Mode**.

Step.3 The indicator light on the mouse wheel will **flash green 3 times**, indicating that the mouse is entering RF mode.

Step.4 On your mouse, press and hold down the left click button, the wheel, and the right click button simultaneously for **3 seconds** and release to trigger **Pairing Mode**.

Step.5 The AZIO IZO mouse will be connected to your device within 10 seconds and is ready for use.

MOUSE DIAGRAM

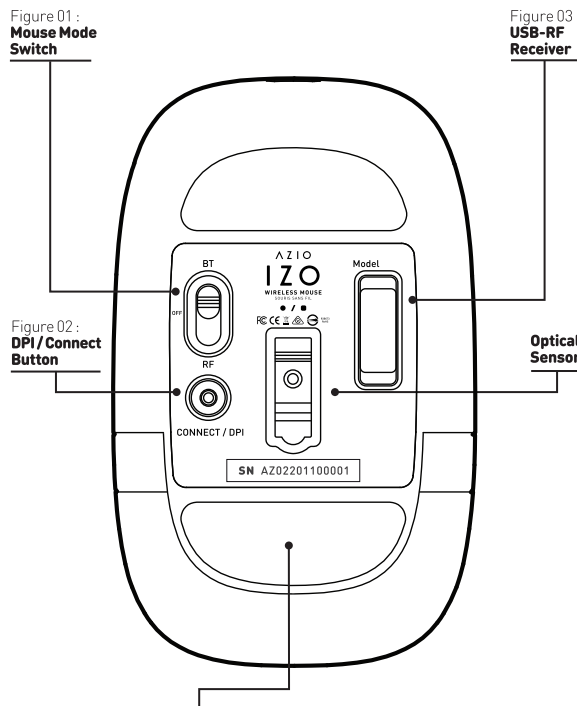
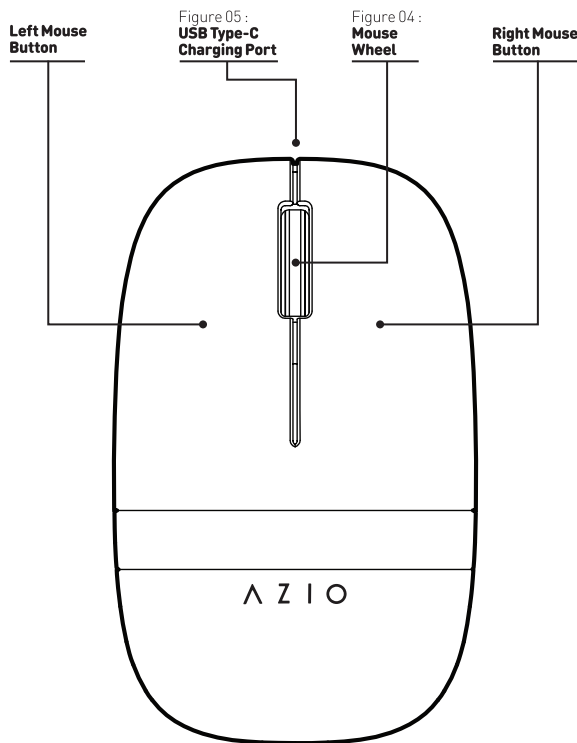

*Please remove the plastic film from the mouse feet before usage.

DPI SETTINGS

Changing the DPI Setting on the Mouse

The AZIO IZO mouse features 3 adjustable DPI settings: 1000, 1600, & 2400. The default is set to 1600 DPI, and to change, simply short-press the button labeled 'DPI / Connect' located on the bottom-left of the mouse. (Fig 02)

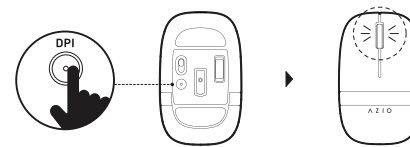

Changing the DPI Setting in BT Mode

Please make sure your mouse is actively connected through bluetooth while attempting to change the DPI settings.

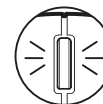

DPI Setting	Indicator Light Display
1000 DPI	Blue light flashes once.
1600 DPI	Blue light flashes twice.
2400 DPI	Blue light flashes three times.

Changing the DPI Setting in RF Mode

Please make sure your mouse is actively connected through the RF-USB receiver while attempting to change the DPI settings.

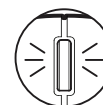

DPI Setting	Indicator Light Display
1000 DPI	Green light flashes once.
1600 DPI	Green light flashes twice.
2400 DPI	Green light flashes three times.

MOUSE BATTERY

Low Battery Indicator

The AZIO IZO mouse has an indicator light in the scroll wheel that will flash red when the mouse is reaching low power levels. (Fig 04)

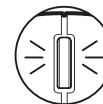

Battery Status	Indicator Light Display
Low Power	Red light flashes continuously (10 times then off)

Charging the Mouse

This mouse has a 1,000mAh Li-ion rechargeable battery and uses a Type-C charging cable included within the package. Please connect the cable into a usb charging port or your computer. Charging a completely drained battery to full on a USB 3.0 port will take approximately **4 hours**. Actual charging time may vary depending on the power output of the charging source. The mouse can be charged in any mode - **BT, RF, or OFF mode**. (Fig 05)

