

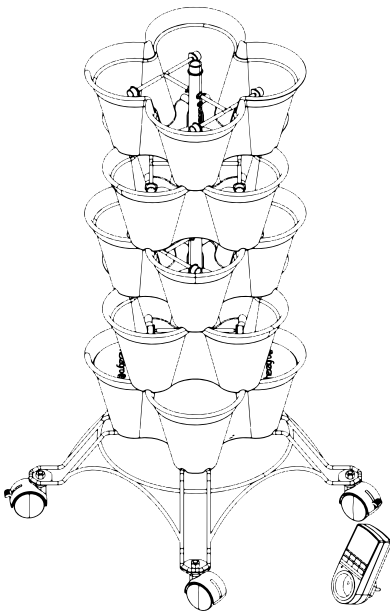

POTY Kit Installation Guide

Manual Version 2.6



POTY S Kit

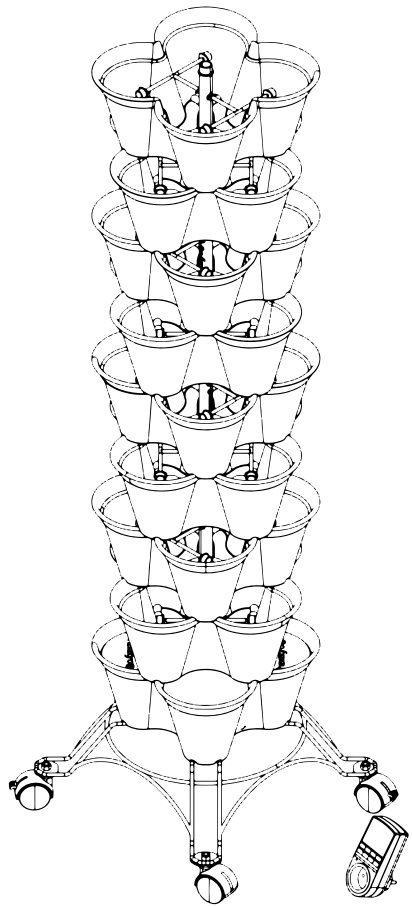

POTY L Kit

You can request the digital version
of this manual or further support by contacting
Hexagro Customer Support at:
link.hexagro.io/support

Please include you **Serial Number** in the object of the
email to be directed to the right support team.

Designed and manufactured in Italy by
Hexagro Urban Farming Srl.

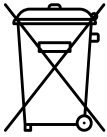

Environmental indications

This household appliance is marked in accordance with the European Directive 2012/19/EU on Waste Electrical and Electronic Equipment (WEEE).

WEEE contains both pollutants (which can have a negative impact on the environment) and raw materials (which can be reused). It is therefore necessary to subject WEEE to appropriate treatment operations to safely remove and dispose of pollutants and extract and recycle raw materials.

Every citizen can play a decisive role in ensuring that WEEE does not become an environmental problem; just follow a few simple rules:

- WEEE should never be thrown into unsorted garbage;
- WEEE must be delivered to Collection Centers (also called ecological islands, recyclers, ecological platforms...) set up by municipalities or urban hygiene companies; in many places, a home pickup service for bulky WEEE is also provided.
- In many countries, when you buy a new appliance, you can give the WEEE to the retailer, who is obliged to pick it up free of charge ("one-for-one" pickup) as long as the new appliance is of the same type and performs the same functions as the one returned.



Safety Precautions and Warnings

You must carefully read through this user manual before installing and using Poty.

Although this appliance does not require any particular technical or botanical knowledge, it is not intended for use by people with limited physical, sensory, or mental abilities, or without experience and knowledge of it, unless they are supervised or instructed in its use by a person responsible for their safety.

1. Read these instructions.
2. Keep these instructions.
3. Read all warnings.
4. Follow all instructions.



Warnings

- **Important information.**
- **Read carefully.**
- **Keep this information for further reference.**

Furniture tip-over

- Serious or fatal crushing injuries can occur from furniture tip-over.
- To prevent this furniture from tipping over it, its **wheels must be permanently fixed with their breaks.**

Important Safety Instructions

- This appliance is designed to be operated by adults.
- The water from your Poty is not suitable for drinking.
- Keep the seed bags, nutrients, and substrates in a safe and dry storage area.
- Use this appliance only for its intended purpose as described in the manual.
- Be familiar with the appliance's use, limitations, and associated restrictions.
- Operating instructions must be read and understood by all persons using or installing this appliance.
- DO NOT use corrosive chemicals or vapors in this appliance.
- DO NOT use this product near water – for example, in a wet basement or near a swimming pool and similar areas.
- Only use parts/accessories specified by the manufacturer.
- The cleanliness of this appliance and its accessories is essential to good sanitation.
- **Unplug the power cord from the outlet and disconnect the timer when Poty is not in use.**

Electrical connection - To avoid risk of electrical shock

- Make sure that the electrical information on the rating plate agrees with the power supply. If not, contact an electrician.
- Always use a correctly installed shockproof socket.
- Make sure not to cause damage to the electrical components (e.g. power plug, power cable), contact an electrician to change the electrical components.
- The power cable must stay always outside the base pot, especially when it has water inside.
- **Do not pull the power cable to disconnect when the system is on.**
- Always pull the power plug when not using the system.
- Close attention is necessary when the system is used by or near children.
- Do not use the system if it has a damaged cable or plug.
- Always be careful when interacting with water and electricity. Make sure the plug is always dry and there is no water on the floor when plugging it in.
- Do not connect the pump to the power if there is no water, otherwise, the pump can be damaged.

Thank you for choosing Poty.

Hexagro aims to provide its customers with the highest quality standards. It is therefore important to us that you have a positive experience using your new Poty system.

This manual was designed in order to guide you through the main steps of the installation process and how to get started, but also to help you to maximize the use and satisfaction you gain from growing plants in Poty. It will also answer the many questions you have about assembly and installation.

Enjoy farming with us!



Join our community!

We are an active and growing community of urban farmers. We would like to invite you to join our Hexagro Community!

Scan the QR code

or Log in to your Facebook page and and

search: ***Hexagro Urban Farming Community - International***

Technical specifications

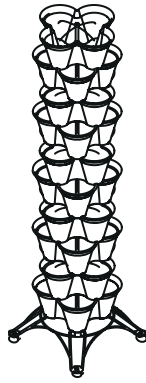

POTY L Kit

POTY S Kit

Dimensions	W 42 cm x L 42 cm x H 154 cm	W 42 cm x L 42 cm x H 83 cm
Yield	40 plants	20 plants
Product Weight	4.8 kg	3 kg
Materials	Recycled PET vases, LLDPE piping, and Iron base	Recycled PET vases, LLDPE piping, and Iron base
Power Supply	Input 100-240 V, 50/60 Hz US power plug, EU or UK power plug	Input 100-240 V, 50/60 Hz US power plug, EU or UK power plug

What you will find in the box

Attention

Check that you have all the items. If there is any missing material, write to Hexagro support: <https://link.hexagro.io/support>

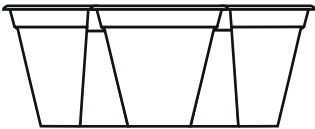

Pot

S Kit: X5

L Kit: X10



**Wheel with
brake**

X2



Metallic base

X1



Wheel

X2

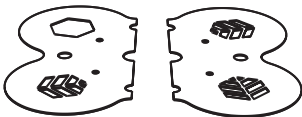

Lid

X1



Knot M8

X4

Irrigation system



Micro-pipe

S Kit: X24

L Kit: X54



Irrigation pipe

S kit: X4

L kit: X9

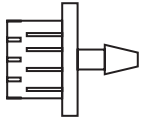

Dripper

S Kit: X16

L Kit: X36



Short pipe

X1



Pump spout

X1



Pipe cap

X1



Water pump

X1



Irrigation timer

X1

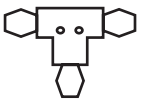

Tee Joint

S kit: X8

L kit: X18

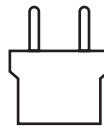

Adaptor

X1

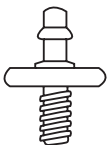

Pipe Adaptor

S kit: X8

L kit: X18



Pump Filter

X1

Extra you will need:

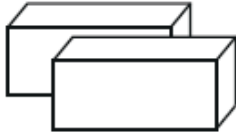

Coco coir substrate blocks



Hydroponic Nutrients

To ensure the irrigation system works properly, avoid using universal soil, instead opt for coconut coir substrate. You can purchase them at Hexagro: store at <https://link.hexagro.io/extra-resources> or a store.

Extra you might need:

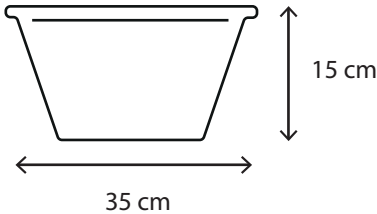

Plastic container (minimum dimensions)

L 35 cm x W 25 cm x H 15 cm

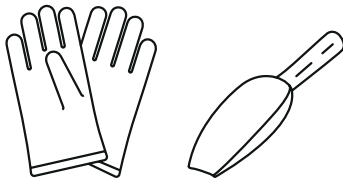

Gloves or a small shovel

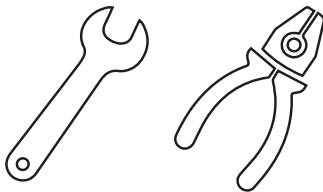

Wrench 8mm e 6mm or pliers

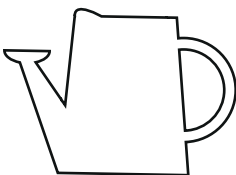

Water

Before starting

Time

Assembly: Approx. 1 hour | Substrate expansion: approx. 20min per block

Where to place it

Consider these recommendations before assembling Poty, it will be heavy to move after placing the substrate.



Choose the location with the most **direct sunlight hours**



Avoid areas with little or none **airflow**



Check the **temperature requirements** for each plant on the **Hexbee App**



Install Poty on a **flat surface**



Avoid to place it on grass or soil surfaces



Place it under a roof (**avoid rain water**)

Hexbee App

Search for this **icon** through the manual, it will let you know that you can find deeper information about specific topics in our **App**.



You will find more information on:

- Substrate hydration
- Assembly
- Irrigation system
- How to take care of plants

A. Joining Hexbee App



Scan the QR code to download Hexbee App and learn how to use Poty explained with images and videos.

Or download it from:



TIP: Make sure to have your **product's serial number** with you during the registration process.



Your serial number
You will find it on the postcard you received in the box

B. Expanding the coco coir substrate

Note: to get started on your cultivation faster, start by expanding your substrate before assembling the system.

One block of substrate allows you to fill two pots.

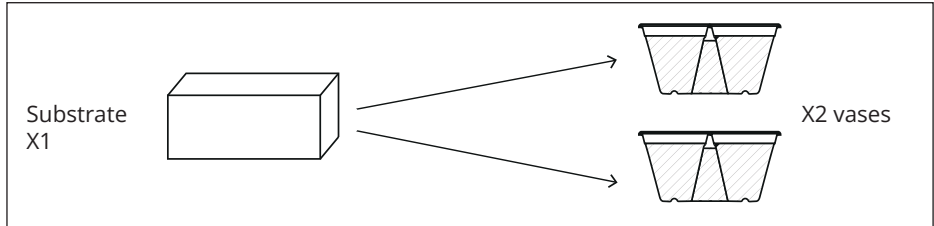

1. Remove all packaging and recycle it



Plastic



Paper

2. 3.5 liters of water
(per substrate)

4ml of each bottle of nutrients
(per substrate)

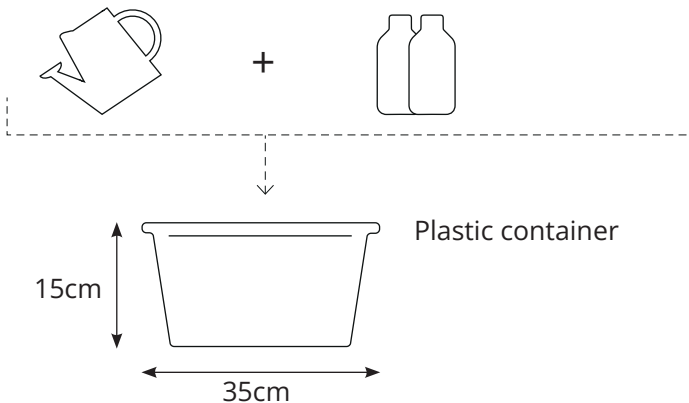

3.

1 block of substrate

Mix of water and nutrients

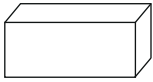

+

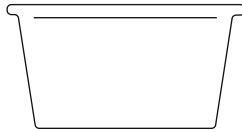

4.

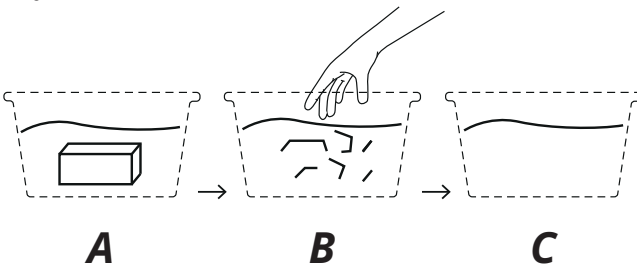

Be careful not to oversoak the substrate, but in case it does, you can always drain it later by hand.



Check on Hexbee **how the hydrated substrate looks like!**
User manual → Assembly manual → Expand your coconut substrate

C. Assembling Poty

1.

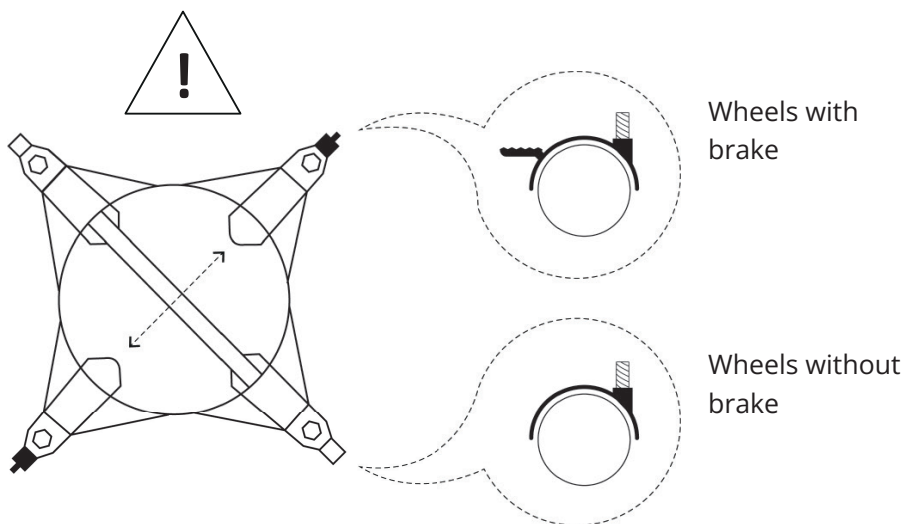
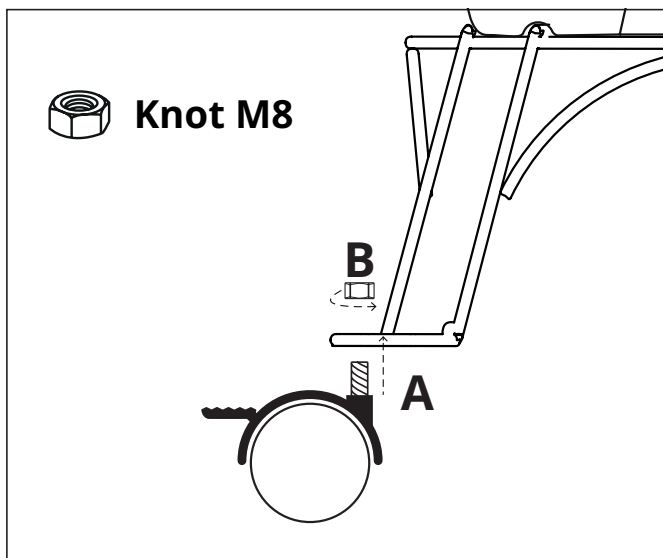

2. Connect the pump spout to the pump.

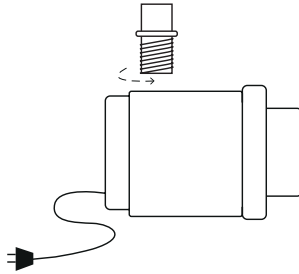

3. Connect the shorter pipe to the water pump, making some pressure. Make sure to insert the pipe properly into the pump's spout.

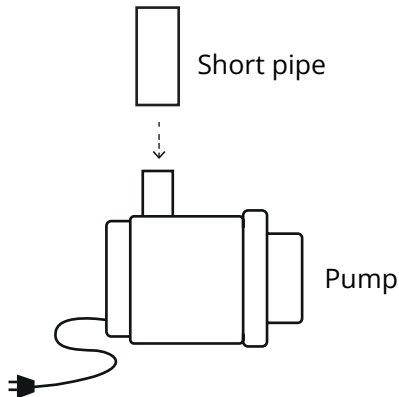

4. Place the pump filter on top of the pump, tie the pump filter firmly from its cords, as high as possible with the electric cable hanging out.

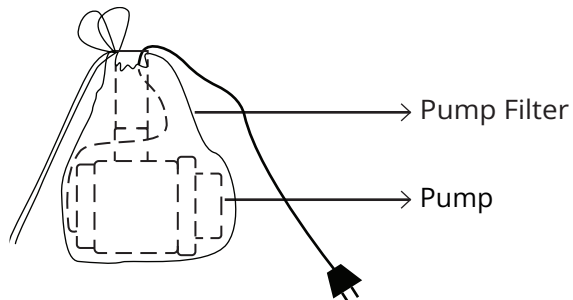

5. Place the pump inside of the base pot, making sure to **align the pipe** of the pump **exactly in the center of the pot**.

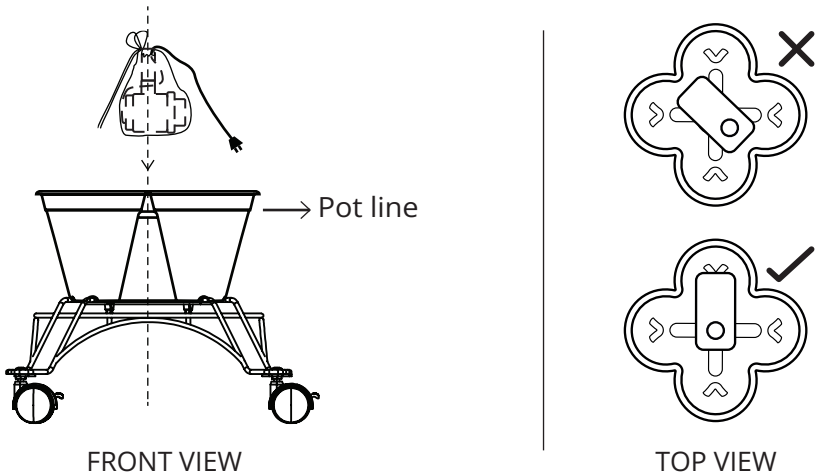

Make sure that the **pump filter** is tied at a level **higher than the pot line**.

6. Place the lid on the base pot (water container).

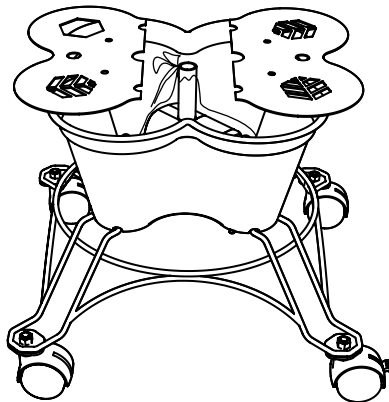

7. Place the white pot.

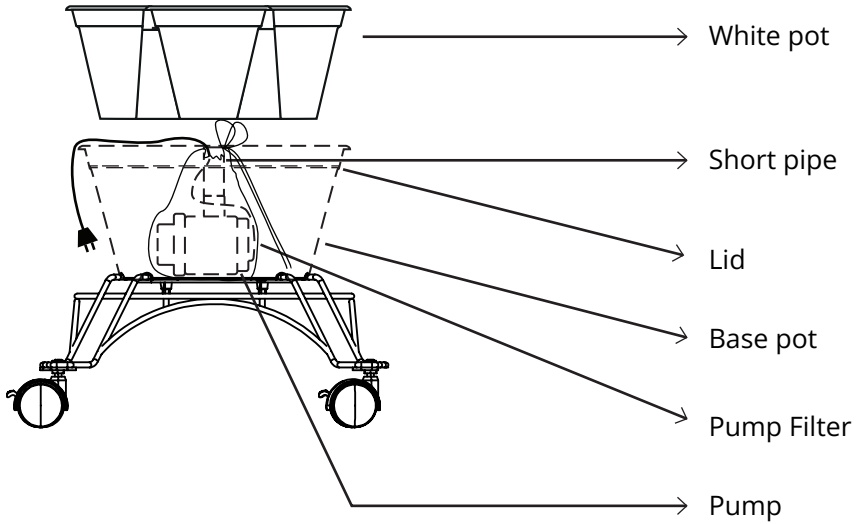

Check on Hexbee **how to assemble the irrigation system**
User manual → Assembly manual → Assemble your Poty

- 8.** Insert all the drippers only on one side of the micro-pipes and leave the other sides empty for now.

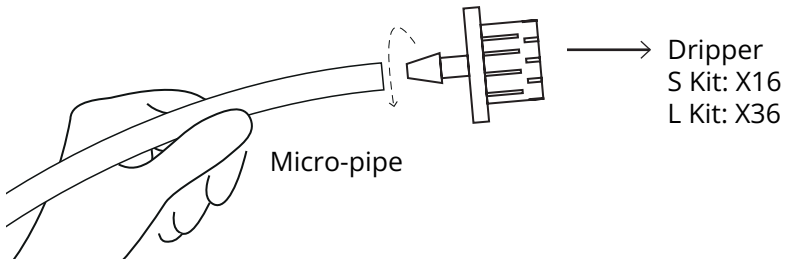

- 9.** Take the unused microtubes. Insert all the pipe adaptors only on one side of the micro-pipes and leave other sides empty for now.

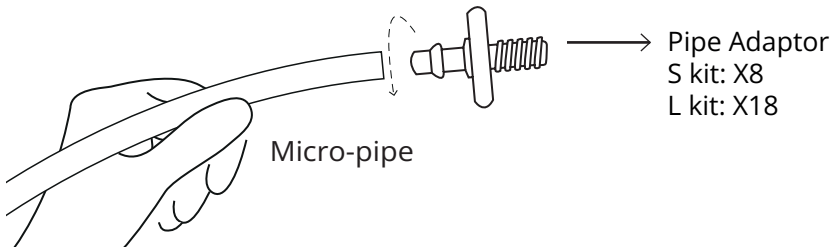

- 10.** Build T's using the previously assembled components.

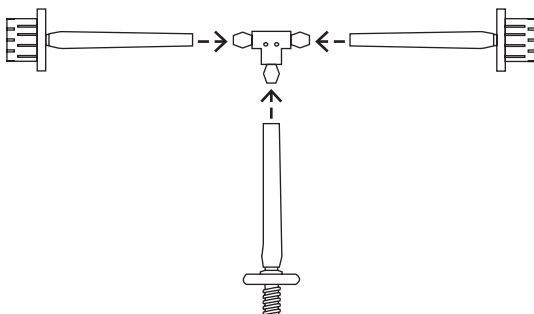

11. Screw the constructed tee structures to the irrigation pipe.

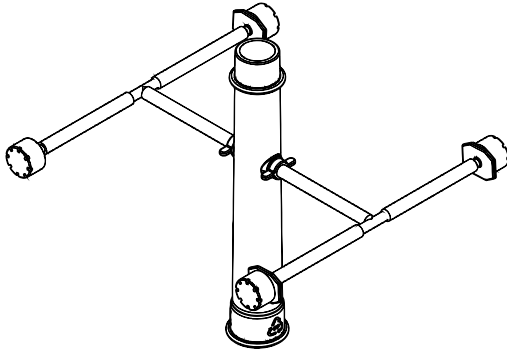

12. Install the irrigation pipe with T's inside the white pot, on the short pipe.

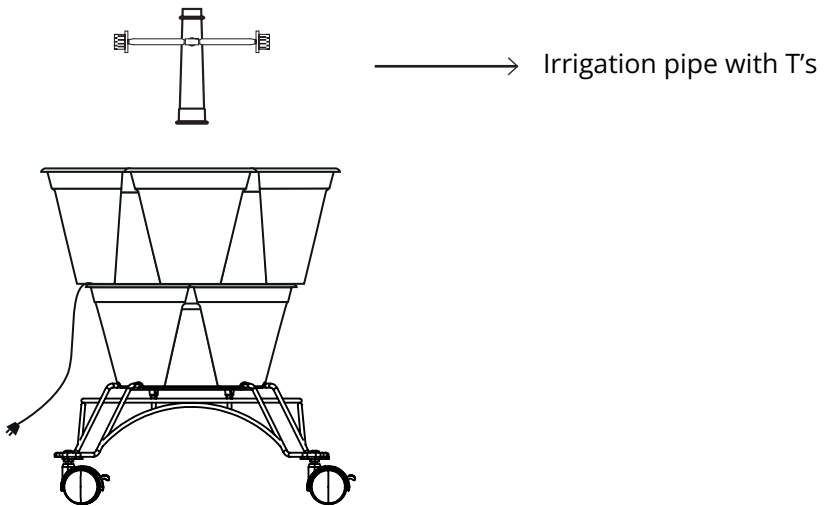

- 13.** Add substrate up to the vase line without compacting it, and leave the drippers above the substrate by slightly lifting the dripper thus bending the micropipe upwards.

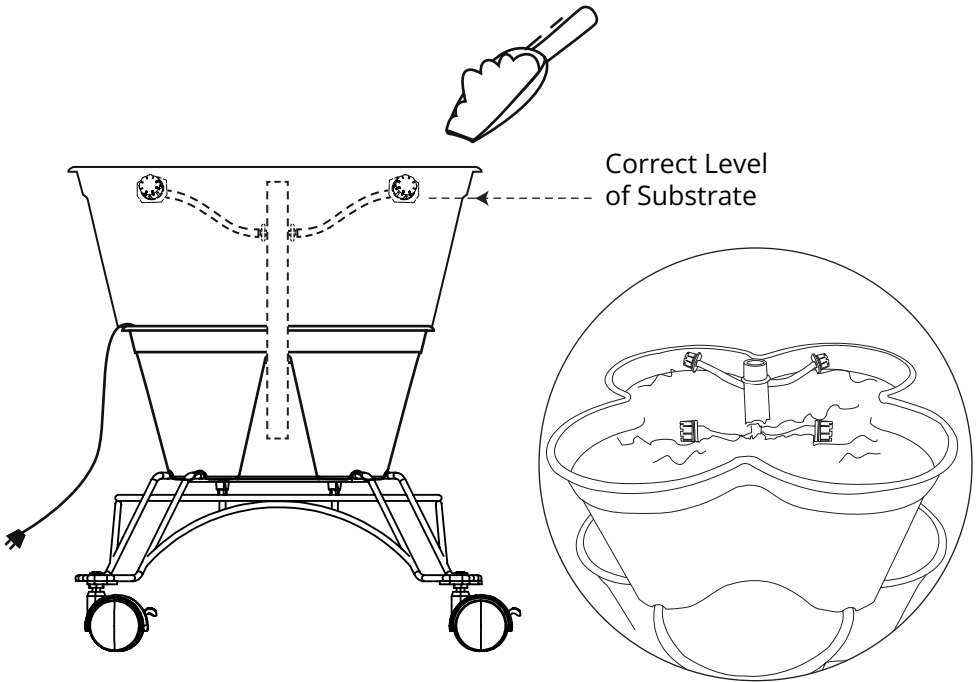

Check on Hexbee **how to add the substrate!**
User manual → Assembly manual → Assemble your Poty

- 14.** Add the next vase **by rotating its alignment**, add the tee shaped micro-pipes to the irrigation pipe and then add its substrate as in the previous steps. Continue this process until all vases are used.

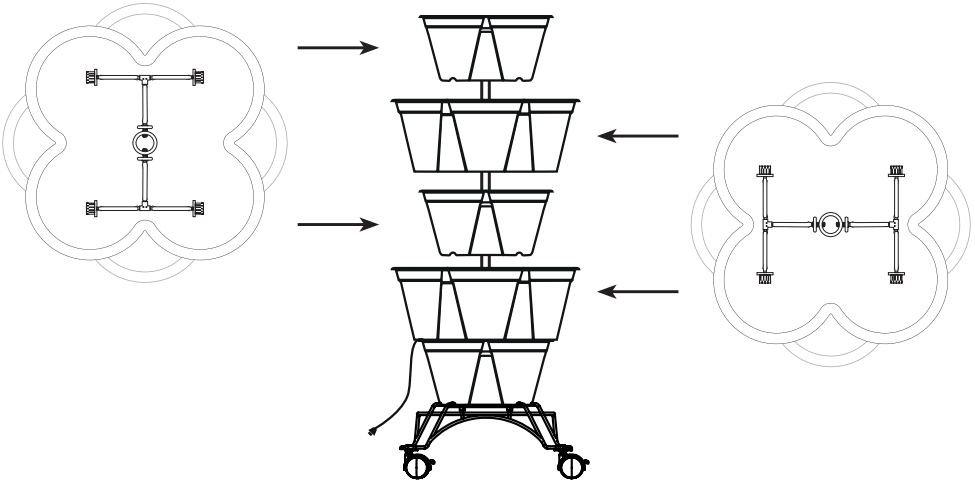

For aesthetic reasons, make sure to alternate the colors of the pots you add (green-white-green...)

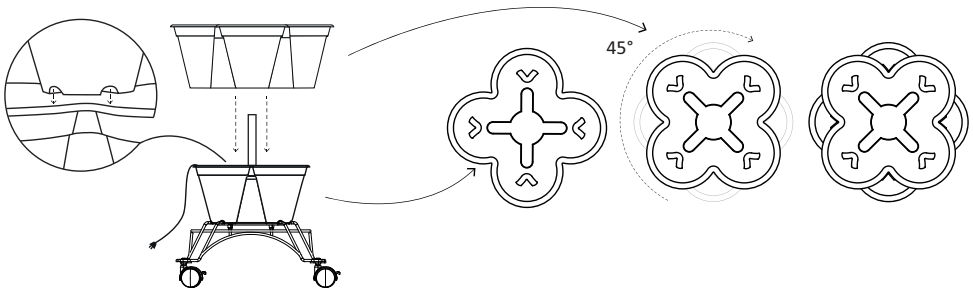

15. Add the pipe cap into the last irrigation tube.

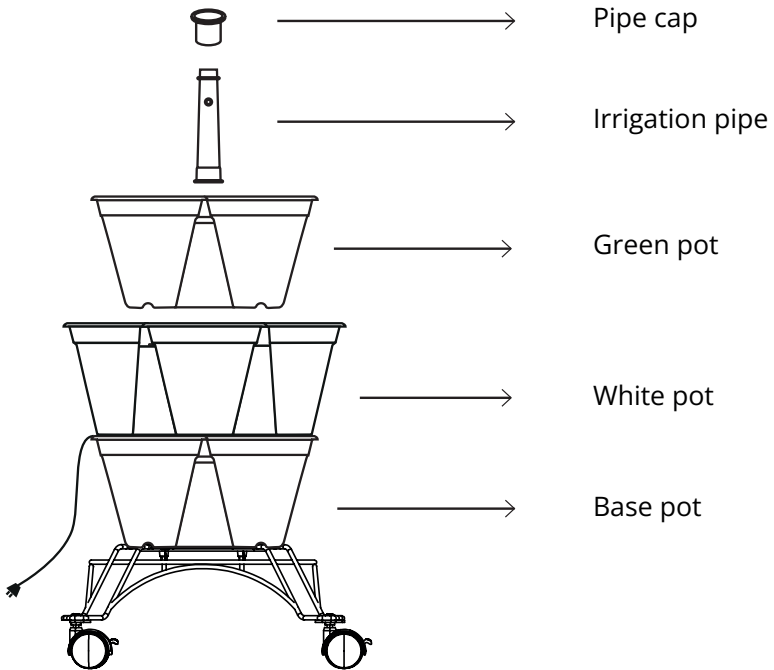

16. Make sure the irrigation system is working correctly.

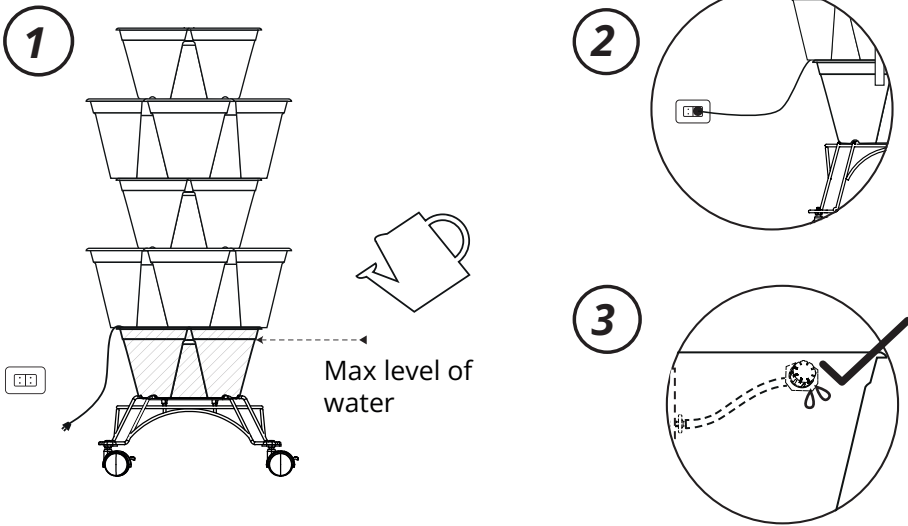

Fill the base pot with nutrient solution (add 1ml from both nutrients for each liter of water), plug the pump to the electricity, and make sure drops of water come out from all the drippers.

Min and max levels of water

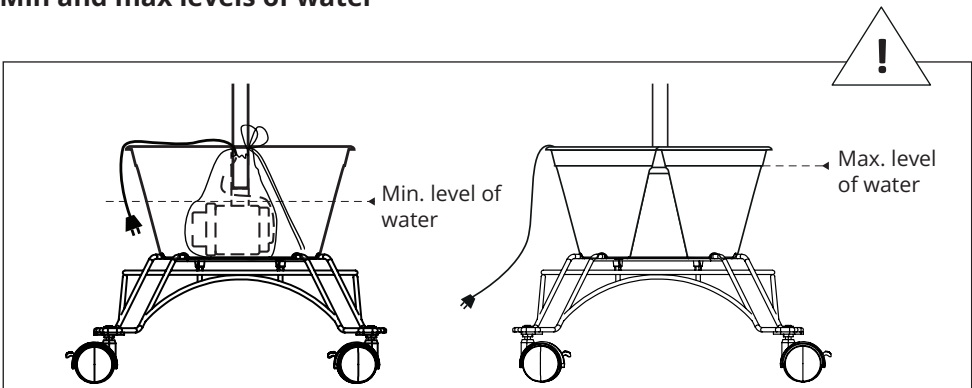

D. Setting timer for irrigation



Check on Hexbee **how to set the timer!**
User manual → Assembly manual → Set up the
irrigation system

Resetting

1. If the timer doesn't show any image, plug it for 10-15 minutes.

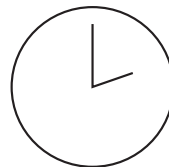
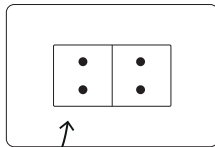
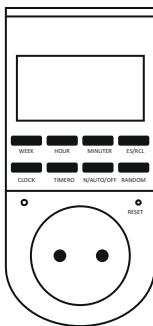

10-15 minutes

2. Reset the timer with the help of a pin before setting new frequencies.

How to reset

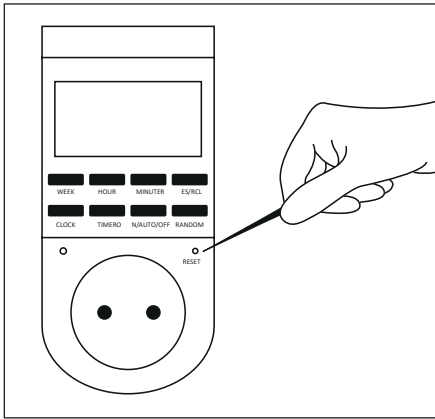

After reset

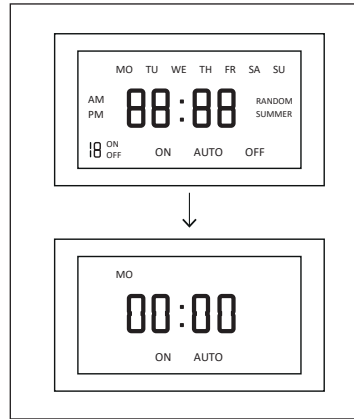

Remember that you need to **reset the timer for the timer's screen to work.**

Setting the current time on the clock

Buttons we will use:

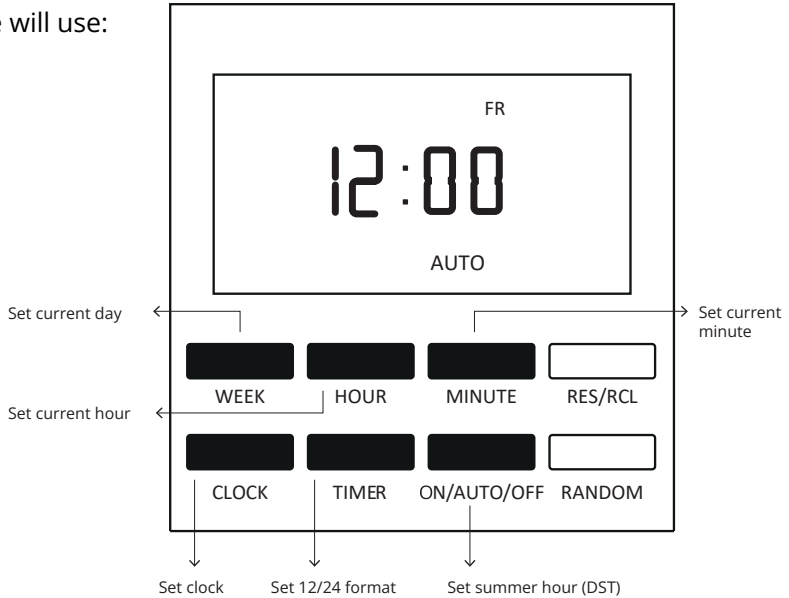

- 1. Clock + Timer at the same time** = choose between **12** and **24** hour format

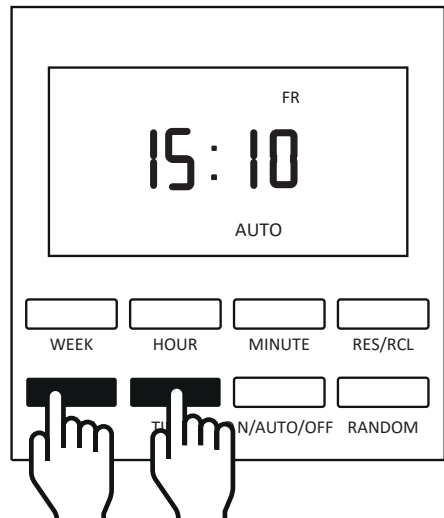

2. **Clock + ON/AUTO/OFF at the same time** = summer hour (DST)

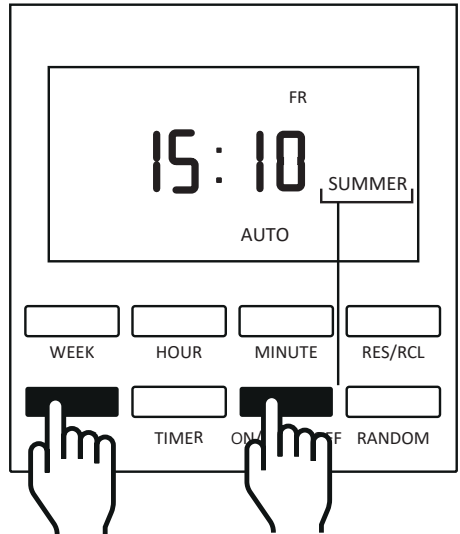

3. **Clock + Week at the same time** = day of the week

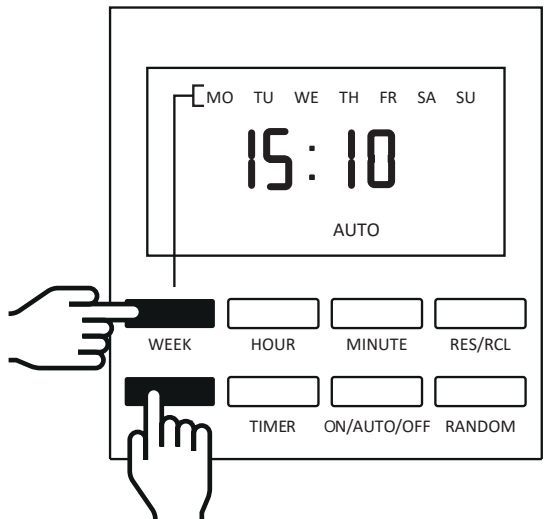

4. Clock + Hour at the same time to = set the hour

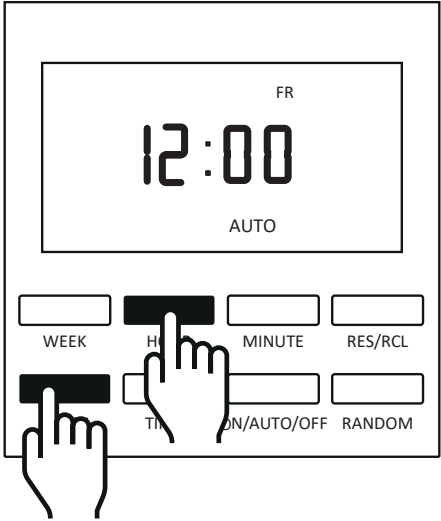

5. Clock + Minute at the same time to set the minutes.

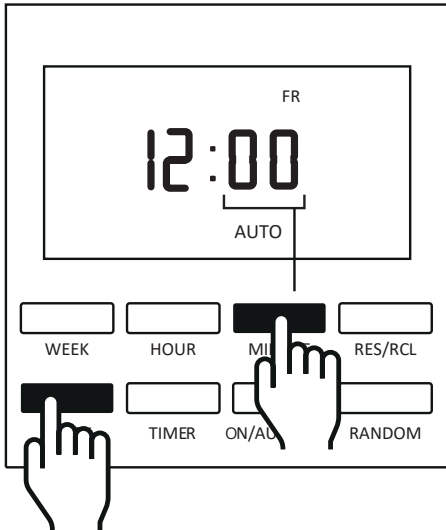

Setting the irrigation frequencies

Buttons we will use:

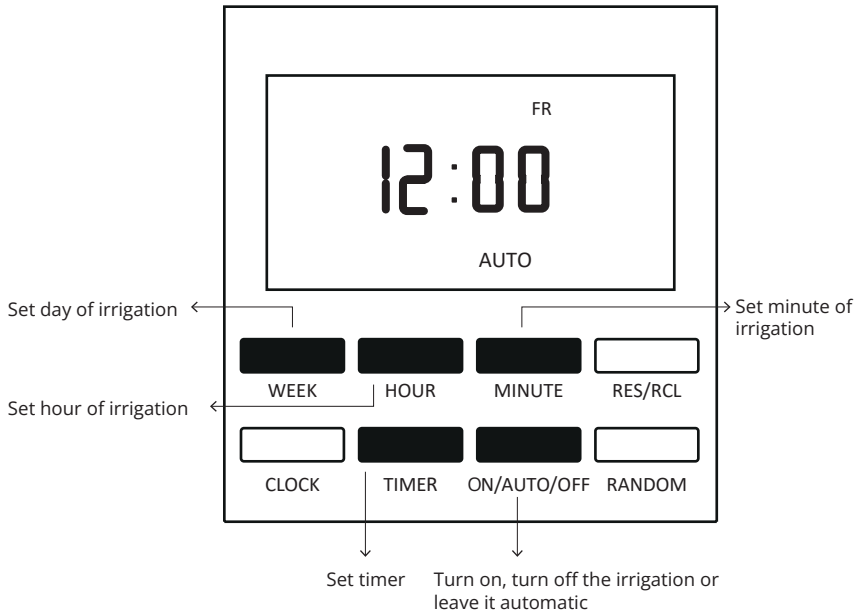

- 1. Timer button** = exact hour and day to start irrigation. Make sure the program is: **1^{on}**

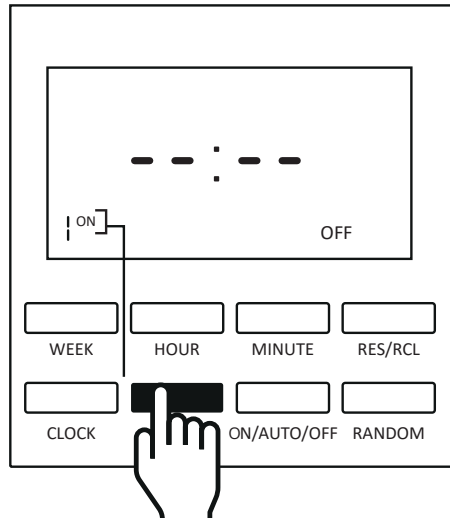

2. Hour and then Minute = hour to start the irrigation.

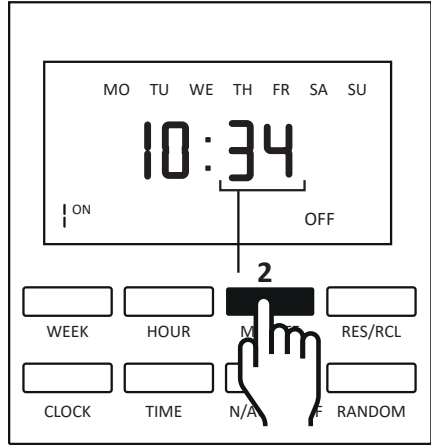
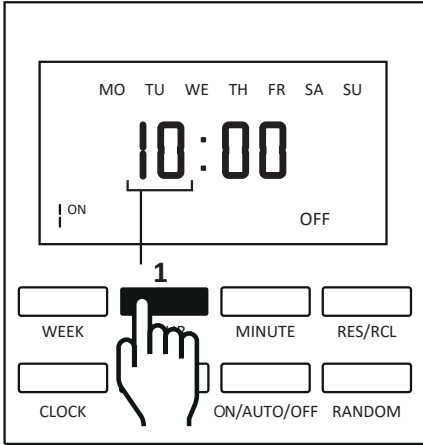

3. Week = set days of irrigation.

Note: to set the default irrigation, press once or several times until the desired days of the week are reached.

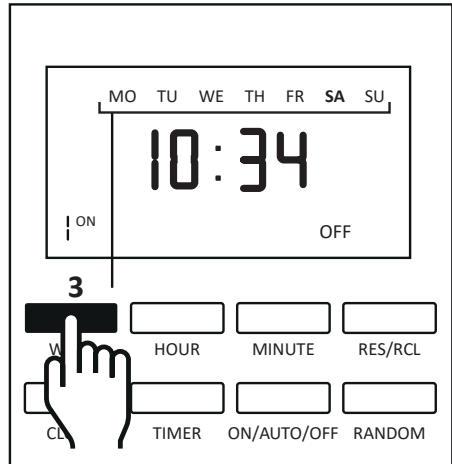

4. Timer again = exact hour and day to finish irrigation.

- Make sure the program is: **1^{off}**
- Make sure that the days of the watering frequencies are **compatible with the day set in step 3.**
- Each irrigation should last **around 15 minutes** (Check Hexbee App for deeper explanation about the time)

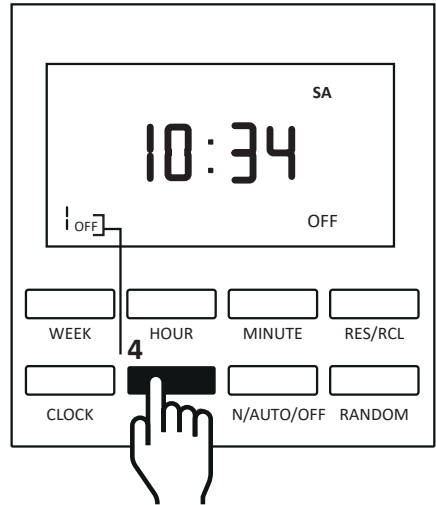

5. Hour and then Minute = hour to finish the irrigation.

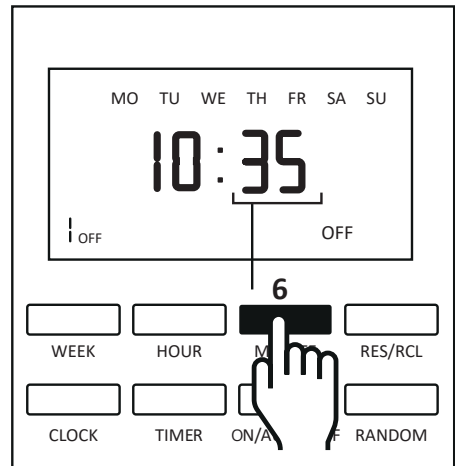
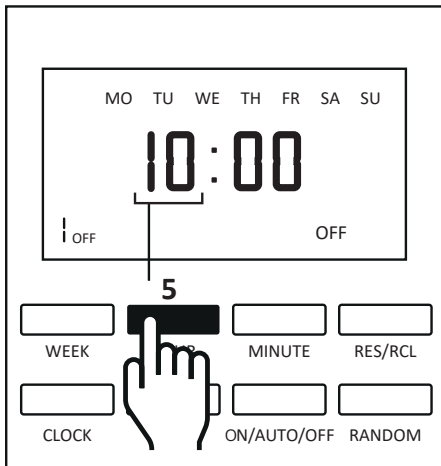

6. **Clock** to exit from setting mode.

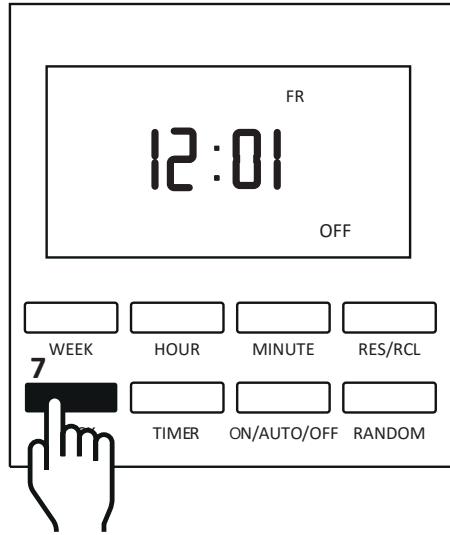

7. **ON/AUTO/OFF** = to set the timer in **Auto** mode.

In Auto mode your automated irrigation will start working.

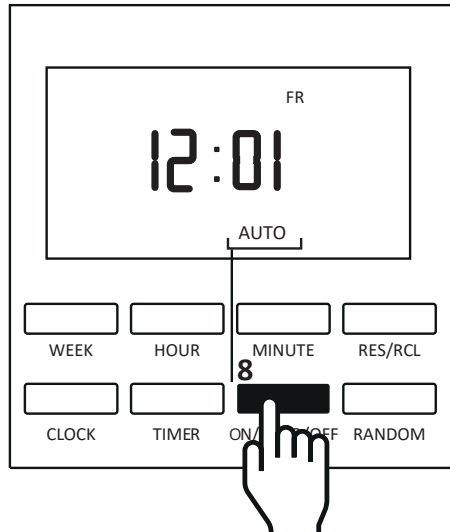

8. Insert the plugs shown in the figure and **make sure they are firmly inserted.**

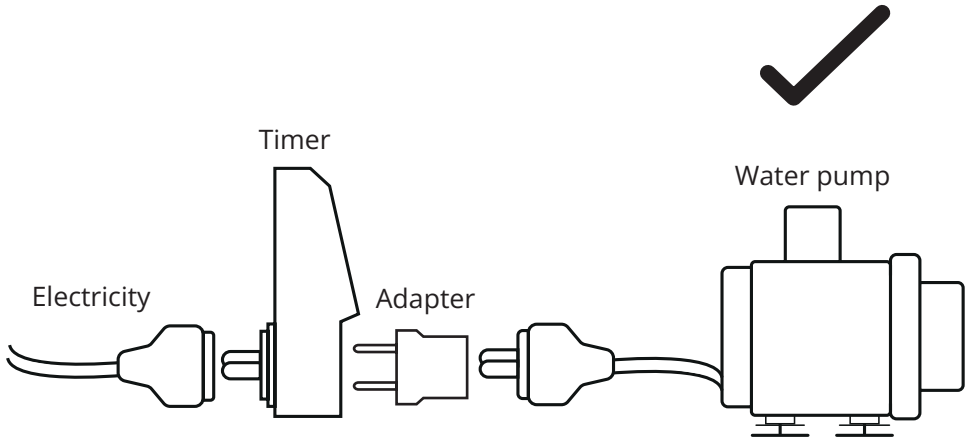

For further information about the timer, check the provider's manual in the box.



You are almost ready now!

To learn **how to take care of your plants**, download our **Hexbee App** by scanning the QR code. It will guide you step by step through your new farming adventure.



Looking for seedlings?

Check out our full catalogue

of seasonal germinated plants at

<https://www.hexagro.io/collections/seasonal-plants>



www.hexagro.io

 *@hexagro.io*

 *@hexagro.io*

 *Hexagro*