

PR-D18

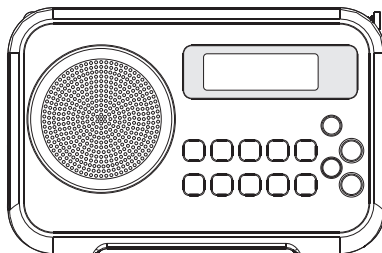

GB

Revision 1

Important safety instructions

GB

1. Read these instructions.
2. Keep these instructions.
3. Heed all warnings.
4. Follow all instructions.
5. Do not use this apparatus near water.
6. Clean only with dry cloth.
7. Do not block any ventilation openings. Install in accordance with the manufacturer's instructions.
8. Do not install near any heat sources such as radiators, heat registers, stoves, or other apparatus (including amplifiers) that produce heat.
9. Do not defeat the safety purpose of the polarized or grounding-type plug. A polarized plug has two blades with one wider than the other. A grounding type plug has two blades and a third grounding prong. The wide blade or the third prong are provided for your safety. If the provided plug does not fit into your outlet. Consult an electrician for replacement of the obsolete outlet.
10. Protect the power cord from being walked on or pinched particularly at plugs, convenience receptacles, and the point where they exit from the apparatus.

11. Only use attachments/accessories specified by the manufacturer.
12. Use only with the cart, stand, tripod, bracket, or table specified by the manufacturer, or sold with the apparatus. When a cart is used, use caution when moving the cart/apparatus combination to avoid injury from tip-over.



13. Unplug this apparatus during lightning storms or when unused for long periods of time.
14. Refer all servicing to qualified service personnel. Servicing is required when the apparatus has been damaged in any way, such as power-supply cord or plug is damaged. liquid has been spilled or objects have fallen into the apparatus, the apparatus has been exposed to rain or moisture, does not operate normally, or has been dropped.
15. To Reduce the Risk of Fire or Electric Shock, Do not Expose This Appliance To Rain or Moisture.
16. The Shock Hazard Marking and Associated Graphical Symbol is provided on the rear of unit.
17. Apparatus shall not be exposed to dripping or splashing and no objects filled with liquids, shall be placed on the apparatus.

18. Excessive sound pressure on ear- and headphones could impair the hearing ability. Higher setting that idle on the equalizer leads to higher signal voltages on the output for ear and headphones.
19. The power plug should be close to the radio, and easy to be approached that during the emergency, to disconnect the power from the radio, just unplug the power plug from the AC power slot.
20. Where the MAINS plug or an appliance coupler is used as the disconnect device, the disconnected device shall remain readily operable.

IMPORTANT NOTE:

To comply with the FCC RF exposure compliance requirements, no change to the antenna or the device is permitted. Any change to the antenna or the device could result in the device exceeding the RF exposure requirements and void user's authority to operate the device.

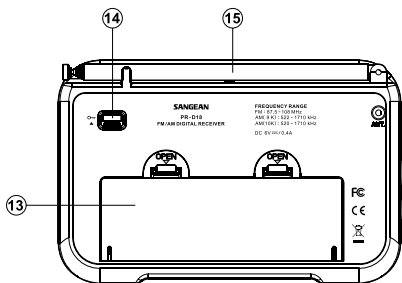
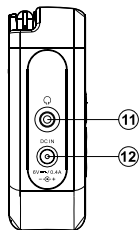
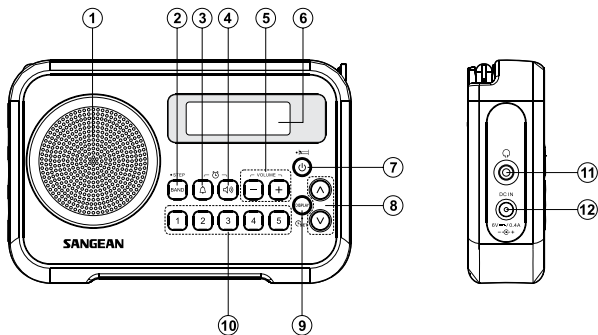
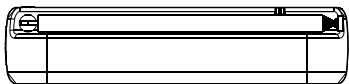

Control

GB

- ① Speaker
- ② Band / step button
- ③ Buzzer alarm button
- ④ Radio alarm button
- ⑤ Volume up / down button
- ⑥ LCD display
- ⑦ Power / Sleep button
- ⑧ Tuning up / down button
- ⑨ Display / Clock set button
- ⑩ Preset button
- ⑪ Headphone socket
- ⑫ DC jack socket
- ⑬ Battery compartment
- ⑭ Key lock switch
- ⑮ Telescopic aerial

Icon display

- Ⓐ FM/AM indicator
- Ⓑ PM indicator
- Ⓒ Stereo indicator
- Ⓓ Buzzer alarm indicator
- Ⓔ Radio alarm indicator
- Ⓕ Sleep timer indicator / Snooze indicator
- Ⓖ Key lock symbol
- Ⓗ Battery indicator
- Ⓘ Volume indicator
- ⓵ Preset indicator
- Ⓚ Frequency / Clock display

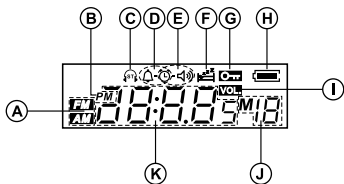

Using the radio for the first time

Battery operation

1. Remove the battery cover on the rear of the unit by pressing the catch.
2. Insert four UM-3 (AA size) batteries into the spaces in the compartment.
3. Take care to ensure all batteries are inserted with correct polarity as shown on the rear cabinet. Replace the battery cover.
4. Reduced power, distortion, “stuttering sound” and the battery icon flashing on the display are all signs that the batteries need replacing.
5. If the radio is not to be used for any extended period of time, it is recommended that the batteries are removed from the radio.

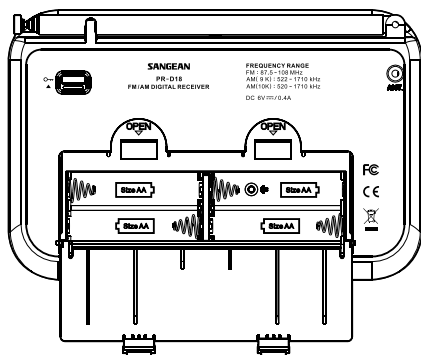

Using the AC power adaptor

The AC power adaptor required for this unit should be 6 volts DC at 0.4 A center pin positive.

Insert the adaptor plug into the DC socket on the left side of the radio.

Plug the adaptor into a standard mains socket outlet.

Whenever the adaptor is used, the batteries are automatically disconnected.

The AC adaptor should be disconnected from the main supply when not in use.

Operating your radio - Search tuning AM / FM

1. Fully extend the antenna above the radio. Press the Power button to switch on your radio.
2. Press the Band button to select the required band.
3. Press and hold the Tuning up/ down button to start the search tuning. Your radio will scan in an upwards direction (low frequency to high frequency) or downwards direction (high frequency to low frequency) and stop automatically when it finds a station of sufficient strength.
4. To find other stations, press and release the Tuning Up / Down buttons.
5. Adjust the volume by pressing the Volume up/down button to the required setting.

Note:

- (1) FM stereo is only available when using headphones.
- (2) To see time or frequency on the screen, press the Display button.

Manual tuning – AM / FM

GB

1. Press the Power button to switch on your radio.
2. Press the Band button to select the required band. Fully extend the antenna for best reception.
3. Press and release the Tuning up/down button to tune to a station. The FM frequency will change in steps of 50/100kHz and AM frequency will change in steps of 9/10kHz.
4. When the waveband end is reached the radio will recommence tuning from the opposite waveband end.
5. Set the Volume using the Volume Up/Down buttons to the desired settings.

Presetting stations

You may store your preferred AM/FM radio stations to the preset stations (1 to 5). The procedure for setting preset Stations is described below.

Note that the radios for AM and FM are saved together in the preset stations so there are 10 of them. Your preset stations will be preserved for 30 minutes when there is no power supply from either the battery or the AC adapter.

1. Press the Power button to switch on your radio.
2. Tune to the required station as previously described.
3. Press and hold the required Preset button (1-5) until you hear a beep sound and the display shows 'M1' for example next to the frequency. The station will be stored using the preset number. Repeat this procedure for the remaining presets as you wish.
4. Preset stations which have already been stored may be overwritten by following the above procedure if required.

Software version / Setting up the tuning step increment / 24 / 12 time format

GB

Software version

The software display cannot be altered and is just for your reference.

1. Make sure your radio is in power off mode.
2. Press and hold the Band/step button until the software version is shown on the display (e.g. P0 X).

Setting up the tuning step increment

3. Continuing pressing and holding the Band / step button until you hear a beep sound. Now the radio enters FM/AM step setting. The screen will show FM tuning step (i.e. 50 or 100). Press the Tuning up / down button to choose between 50KHZ or 100 KHZ and then press the Band / step button to confirm the selection.
4. After the selection of FM tuning step, the display will show AM tuning step (i.e. 9 or 10). Press the Tuning up / down to choose between 9KHZ or 10 KHZ and then press the Band / step button to confirm your selection.

24/12 time format





5. After the confirmation of AM tuning step, current 12/24 time format will flash on the display. Press the Tuning up / down button to selection your requested option. Then press the Band / step button to confirm your selection.

Clock setting

1. Press and hold the clock set button until the radio beeps once and the hour digits of time setting begins to flash.
2. Press the Tuning Up / Down button to adjust the hour setting as required. Then press the clock set button to confirm the hour setting. Now the minute digit of the setting will flash on the display.
3. Press the Tuning up / down button to adjust the minute setting as required. Then press the clock set button to confirm the setting. Your radio clock is now set.

Alarm setting

There are two different alarm modes in this unit. You can choose to wake up to the radio or to a buzzer. You can set the alarm with the radio on or off.

1. Press and hold the Alarm button until you hear a beep and see one of these symbol - or - flashing on the display.
2. Now both the hour digit and alarm symbol will flash. Press the Tuning up / down button to set the required hour. Press the Alarm button again to confirm the setting.
3. Now the minute digit will flash on the display. Press the Tuning up / down button to adjust the required minute. Press the Alarm button again to confirm the minute setting. If you are setting the radio alarm () , please go to step 5. Otherwise, please follow the next step.

4. Press the Tuning up / down button to adjust the volume. Then press the Alarm button to confirm the setting. Now the alarm setting is completed. Once the alarm is set, it will automatically go off the next day at the same time.
5. If the radio alarm is selected, you need to choose the station to wake up to. Press the Band button and then the Tuning up / down button to tune the radio to your favorite station. Or you can choose from the preset stations by pressing the Tuning up / down button and then Preset 1-5 button. Press the Alarm button to confirm the setting.
6. Press the Tuning up / down button to adjust the volume. Then press the Alarm button to confirm the setting. Now the radio alarm setting is completed.

Snooze

When the alarm sounds, press any button other than the Standby button will silence the alarm for 5 minutes.  will appear on the display.

To cancel the snooze timer while the alarm is suspended, press the Power button.

Turning off the sounding alarm

Press the Power button to turn off the sounding alarm, otherwise, the alarm will sound for an hour.

Cancelling the alarm setting

Press and hold the Alarm button until you hear a beep and the alarm symbol will disappear on the display.

Sleep timer

Your radio can be set to turn off automatically after a preset time has elapsed. The Sleep Timer setting can be adjusted between 15,30, 45, 60, 90 and 120 minutes.

1. Press and hold the Power / Sleep timer button until you hear a beep and the symbol of  shows on the display.
2. Holding the Power / Sleep timer button down will cycle through the times of 120, 90, 60, 45, 30 and 15 minutes.
3. Release the button when the desired sleep timer option appears on the display. Now the symbol will appear on the display. The radio will shut off after a preset time has elapsed.

Note:

To deactivate the sleep timer, simply press and release the Power button.

Headphone socket

A 3.5mm stereo headphone socket is provided on the left hand side of your radio for use with headphones. Inserting a plug automatically mutes the internal speaker.

GB

Note:

FM stereo is only available when using headphones.

IMPORTANT:

Excessive sound pressure from earphones and headphones can cause hearing loss.

Key lock function

The key lock function is used to prevent unintentional operation of the radio.

1. Key lock switch is located on the rear of the radio. When the key lock switch is set to LOCK, every button will be disabled. Display will show the lock symbol 
2. To disable the key lock function switch the key lock button to off position. The key lock function will be disabled.

Specifications

Power Requirements

Mains	DC in 6V / 0.4 A
Battery	4 X 1.5V Size "AA" / UM-3 / LR6

Frequency Range

FM 87.5 – 108 MHz

AM (9K) 522 – 1710 kHz

AM (10K) 520-1710 kHz

Circuit Features

Loudspeaker	2.25" 8 ohm full range
Output Power	1 Watt (max)
Headphone socket	3.5mm dia.
Aerial System	FM Telescopic aerial



If at any time in the future you should need to dispose of this product please note that: Waste electrical products should not be disposed of with household waste. Please recycle where facilities exist. Check with your Local Authority or retailer for recycling advice. (Waste Electrical and Electronic Equipment Directive)