



User manual for Spectrum Black

This manual provides information on monitor features, setting up and using the monitor, and technical specifications, for the following 27-inch W-OLED Spectrum Black monitor models developed by Dough:

ES07E2D, ES07E2F

© Copyright 2024 Dough GmbH

AMD, the AMD Arrow logo, FreeSync™, and Radeon™ are trademarks of Advanced Micro Devices, Inc. NVIDIA®, the NVIDIA® logo, GeForce®, and G-SYNC™ are trademarks and/or registered trademarks of NVIDIA Corporation in the United States and other countries. DisplayPort™, the DisplayPort™ logo, and VESA® are trademarks and/or registered trademarks of the Video Electronics Standards Association in the United States and other countries. HDMI®, the HDMI® Logo, and High-Definition Multimedia Interface are trademarks and/or registered trademarks of HDMI Licensing LLC. USB Type-C® and USB-C® are registered trademarks of USB Implementers Forum. Corning® and Gorilla® Glass are registered trademarks of Corning Inc. Windows is a trademark and/or registered trademark of Microsoft Corporation in the United States and other countries. Other company and product names may be trademarks of the respective companies with which they are associated.

The information contained herein is subject to change without notice. The only warranties for Dough products and services are set forth in the express warranty statements accompanying such products and services. Nothing herein should be construed as constituting an additional warranty. Dough shall not be liable for technical or editorial errors or omissions contained herein.

First Edition: May 2023

About this manual



CAUTION

Indicates there's a hazardous situation that could be dangerous and cause injury or even death. It's important to follow the instructions closely to avoid this risk.



IMPORTANT

Indicates that the information is significant, but not necessarily hazardous. It could relate to the proper functioning of your device or avoiding property damage or data loss.



NOTE

Provides additional information to clarify or supplement important points in the main text. Notes may provide helpful hints for completing a task.



This product incorporates HDMI technology.

FCC Compliance Notice

This equipment has been tested and found to comply with the limits for a Class B digital device, pursuant to part 15 of the FCC Rules. These limits are designed to provide reasonable protection against harmful interference in a residential installation. This equipment generates, uses and can radiate radio frequency energy and, if not installed and used in accordance with the instructions, may cause harmful interference to radio communications. However, there is no guarantee that interference will not occur in a particular installation. If this equipment does cause harmful interference to radio or television reception, which can be determined by turning the equipment off and on, the user is encouraged to try to correct the interference by one or more of the following measures:

- Reorient or relocate the receiving antenna.
- Increase the separation between the equipment and receiver.
- Connect the equipment into an outlet on a circuit different from that to which the receiver is connected.
- Consult the dealer or an experienced radio/TV technician for help.

Table of contents

About this manual	3
Table of contents	4
Getting started	8
Important safety information.....	8
About Spectrum Black.....	9
Front components.....	10
Rear components.....	10
Rear components.....	11
Setting up Spectrum	12
Installing the Spectrum Stand.....	12
Removing the Spectrum Stand	13
Attaching a VESA mount.....	14
Connecting the power cable.....	15
Connecting video cables.....	16
Connecting USB devices	17
The built-in USB hub.....	17
Connecting peripheral devices	17
Connecting to the USB host device(s)	18
Connecting an audio device.....	19
Installing a security cable	19
Setting up your workspace.....	20
Adjust your monitor	20
Stay active	21
Watch your eyes.....	22
Blue light.....	22
Screen flicker.....	22
Using the monitor	23
Turning on the monitor.....	23
Turning off the monitor	23
Cool features.....	24
One-cable solution.....	24
KVM switch.....	25
Quick actions.....	26
Restore default settings.....	26
Using the on-screen display.....	27
Controlling the OSD menu.....	27
OSD components.....	28
Live information display	28

OSD menu	28
Help display.....	28
Input/Output menu	29
Select video input source.....	29
Dual-screen	29
Secondary input source	29
Audio source	29
USB Type-C port 1 mode.....	30
DisplayPort mode.....	30
HDMI port 1 mode	30
HDMI port 2 mode.....	30
Volume.....	31
Audio equalizer	31
USB hub menu	32
Host device override	32
USB Type-C port 1 host device.....	32
DisplayPort host device.....	32
HDMI port 1 host device.....	32
HDMI port 2 host device	32
Gaming menu.....	33
Frame counter	33
Frame counter color.....	33
Frame counter transparency	33
Frame counter position	33
Crosshair.....	34
Crosshair color	34
Crosshair transparency.....	34
Crosshair style.....	34
Crosshair position.....	34
Black equalizer.....	35
Presets menu.....	36
Load factory defaults	36
Load user preset 1.....	36
Load user preset 2	36
Load user preset 3	36
Save preset.....	36
Picture menu.....	37
Color space.....	37
Brightness	37

Contrast	37
Sharpness	37
Color temperature.....	37
White point gain	37
Gamma.....	38
EOTF	38
Upscaling mode	38
Brightness control.....	39
Performance menu	40
Low-latency mode.....	40
Adaptive-Sync.....	40
Black frame insertion	40
Minimum strobe frequency.....	40
Energy saving mode	40
Faster start-up.....	40
Unlock brightness	41
USB hub & power	41
OSD menu.....	42
Language	42
Position	42
Transparency	42
Time-out	42
Rotation.....	43
Quick action: joystick up/down/left/right, KVM button	43
Indicator light menu.....	44
On Behavior	44
On brightness.....	44
On color.....	44
Standby behavior	44
Standby brightness	44
Standby color.....	44
Maintenance menu	45
Screen shift.....	45
Screen saver.....	45
Logo extraction algorithm	45
Local brightness control	45
Temporal Target Curve	46
Convex Power Control.....	46
Temporal peak luminance control.....	46

Transistor wear compensation.....	46
OLED wear compensation	47
Information menu.....	47
Model	47
Serial number	47
Firmware version	47
Total usage time	47
Support and troubleshooting.....	48
Cable requirements	48
DisplayPort	48
HDMI.....	49
USB Type-C	50
Solving common problems	52
Updating firmware	53
Contacting support	54
Locating the model and serial number	54
Maintaining the monitor.....	55
Maintenance guidelines.....	55
Cleaning.....	56
Shipping	56
Disposal	56
Technical specifications	57
Display.....	58
Size	58
Image quality	58
Speed.....	58
Technology	59
Ports.....	59
Video input.....	59
USB hub	60
Audio	60
Features.....	60
Adjustment.....	61
Stand	61
Size and weight.....	61
Electrical and operating requirements	62
Limited warranty.....	62
In the box.....	62

Getting started

Important safety information

Only use the power cord and AC adapter that came with your monitor. They're designed to work together and have been tested to ensure they're safe.

Always plug the power cord into an outlet that's easy to reach. When you need to unplug the monitor, hold the plug firmly and pull it out of the outlet. Don't pull the cord itself.

The plug on the power cord is designed to fit into a grounded outlet, which is a safer type of outlet. Make sure the outlet you're using is grounded before you plug in the monitor. Don't disable or remove the grounding pin or use a 2-pin adapter to circumvent it.

Check the ampere rating of the products you have plugged in, and make sure the total rating of everything you've plugged in doesn't exceed the rating of the outlet or power cord. Look at the power label on each device to find its ampere rating.

Don't block or cover the slots and openings on the monitor. This can prevent it from ventilating properly and could cause it to overheat. Don't put anything into the slots or spill any liquid on or into the monitor.

Keep the monitor in a place where it can get good airflow and isn't exposed to too much light, heat, or moisture.

Don't use the monitor in any area where there could be an explosion or fire risk, such as places where chemicals or gases are present. These areas may be marked, but not always. Examples include storage facilities, vehicles using propane or butane, and places where the air contains chemicals, dust, or metal powders.

To protect your computer and monitor, connect all power cords to a surge protection device like a power strip or uninterruptible power supply (UPS). Not all power strips offer surge protection, so make sure the one you use is labeled as such.

To avoid serious injury, set up your workstation properly and maintain good posture and healthy habits while using your computer.

Be careful not to place anything on the power cords or cables. Arrange all cords and cables so that they can't be pulled, stepped on, or tripped over.

Don't drop the monitor or put it on an unstable or vibrating surface. Use furniture that's designed to properly support your monitor. Avoid placing your monitor on dressers, bookcases, shelves, desks, speakers, chests, or carts because it could fall over and cause damage or personal injury.

This product is intended for entertainment purposes. To avoid distractions or disturbing reflections on the screen, consider placing the monitor in an area with controlled lighting. Avoid bright surfaces or direct light sources that could interfere with your viewing experience.

About Spectrum Black

We believe the best products are built hand in hand with the enthusiasts that use them. Every product in our portfolio is crowd-developed with a global community of tech, gaming, and productivity enthusiasts. Spectrum Black is no exception. As a result, it has everything you need and nothing you don't. Designed for gamers who demand the best from themselves and from their gear, Spectrum Black delivers cutting edge performance and unparalleled image quality.

Once you try OLED you don't want to go back. No blooming, deep blacks and infinite contrast ratio have long been core to OLED technology, but the micro lens array in our 3rd generation W-OLED panel drives the brightness higher than ever before.

Spectrum Black is available with a standard hazy matte polarizer to reduce reflections. But our community of enthusiasts from around the world has spoken: reducing reflections is not worth the drop in black levels, sharp detail, and vibrant colours. That's why we also offer Spectrum Black with Corning Gorilla Glass, unleashing the full potential of our OLED panel. Conventional glass is reflective, but Corning's DXC anti-reflective treatment reduces reflections, increases clarity, and protects from scratches without compromising on image quality.

If you're serious about winning, you'll take every advantage you can get. Spectrum Black is packed with features that elevate your gameplay. We can't promise that you'll win every game, but we can promise you won't lose because of your monitor.

With refresh rates up to 240Hz and a response time of less than one millisecond all your frames stay sharp and in focus. Strobing reduces motion blur and enhances the visual clarity of fast-moving objects, so black frame insertion (BFI) boosts your performance in fast paced games.

Although OLED is already one of the fastest technologies on the market, we focused on reducing display lag as much as possible, so you see the action as it happens, not after the fact. Between FreeSync, G-SYNC, and HDMI 2.1 you get smooth animations without distracting tears or stutters no matter what gear you use.

Our customizable crosshair overlay improves your aim, and black equalizer enhances dark scenes, so you never miss an enemy in the dark. Spectrum gives you an edge in every fight.

We made sure to have a wide selection of ports available. HDMI 2.1 ensures that you can use new features such as variable refresh rate on the latest consoles, and our Type-C port will connect your monitor and peripherals to your laptop with a single cable, while charging it at the same time!

Cable management is easily the biggest pain point for anyone trying to set up a tidy desk. Reducing the number of cables also helps reduce clutter, dust build-up, and the risk of something getting stuck or pulled off your desk. Our built-in USB hub, KVM switch, 100W USB-C charger and dedicated audio amp let you get more done with fewer cables. Without the clutter, you can focus on your game.

We are aware that one of the major concerns of OLED technology is image retention, often called 'burn-in'. Spectrum Black comes with several features that reduce and counteract the causes of image retention. Additionally, we have developed a cooling system that further prolongs the lifetime of your monitor. But don't just take our word for it, our warranty covers burn-in for 2 years. So, all you have to worry about is winning.

You can find more detailed information in the Technical Specifications section on page 57.

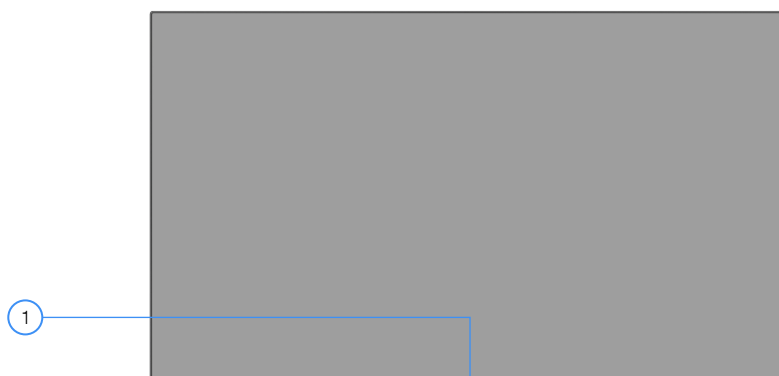

Front components



Component	Description
1 Indicator light	Identify the current state of the monitor.

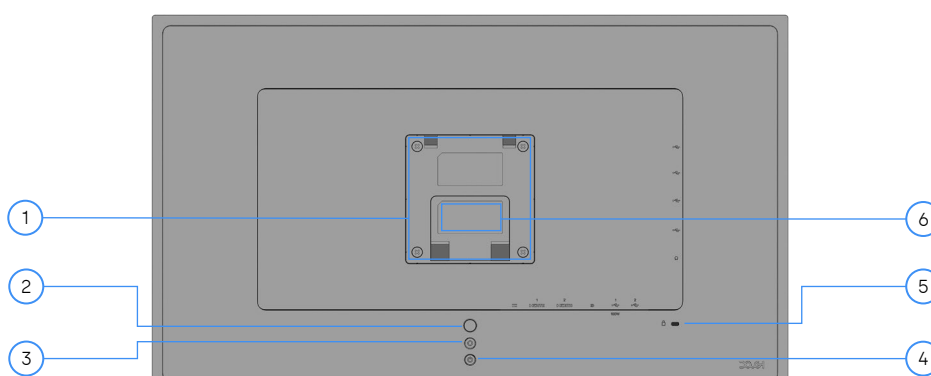





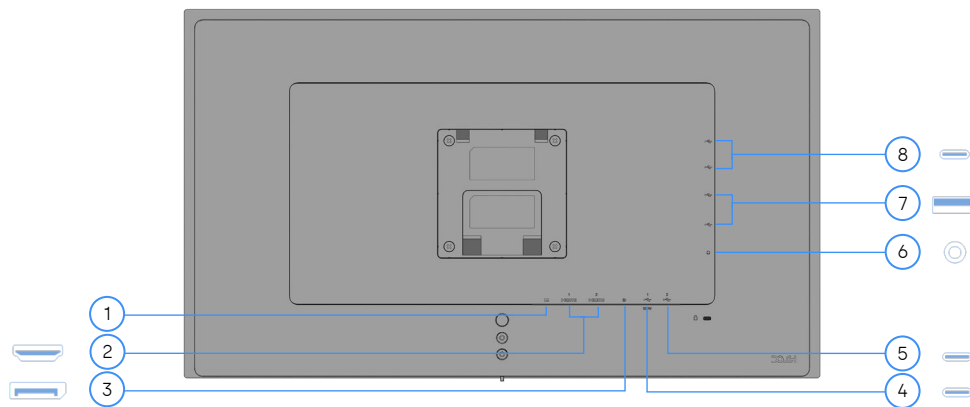

Rear components



Component	Description
1 Stand/VESA connector	Connect the Spectrum Stand or a VESA-compatible mounting device.
2 5-way joystick	Open, close, and control the OSD menu. Enable quick actions.
3 KVM button	 Switch between the primary and secondary video input source. Can be set up to perform a different quick action.
4 Power button	 Turn the monitor on and off.
5 Kensington security slot	 Connect a security cable to secure the monitor to a fixed object.
6 Serial number label	Identify your monitor's unique serial number.

Rear components



Component	Description
1 DC power port	 Connect the adapter to power the monitor.
2 HDMI port (2x)	1  2 
3 DisplayPort port	 Connect a DisplayPort cable to a video source device such as a computer.
4 USB Type-C port with DisplayPort Alt Mode, USB upstream data, and USB Power Delivery	1  100W Connect a USB cable to a video source device such as a desktop or laptop computer. Connect a USB cable to power or charge USB-PD compatible devices up to 100W. Connect a USB cable to a USB host device such as a desktop or laptop computer to enable the built-in USB hub.
5 USB Type-C port for USB upstream data only	2  Connect a USB cable to a USB host device such as a desktop or laptop computer to enable the built-in USB hub.
6 3.5mm audio jack	 Connect headphones or speakers.
7 USB Type-A port (2x) for downstream data	 Connect USB cables to peripheral devices, such as a keyboard, mouse, or hard drive to the built-in USB hub. Power or charge devices up to 5W.
8 USB Type-C port (2x) for downstream data	 Connect USB cables to peripheral devices, such as a keyboard, mouse, or hard drive to the built-in USB hub. Power or charge devices up to 15W.

Setting up Spectrum

It is important to set up your monitor correctly. That way you keep your gear and yourself safe, so you can focus on enjoying your equipment without worry.



IMPORTANT

To prevent damage to the monitor, do not touch the surface of the LCD panel. Pressure on the panel may cause nonuniformity of color or disorientation of the liquid crystals. If this occurs, the screen will not recover to its normal condition.

Installing the Spectrum Stand

The Spectrum Stand (sold separately) was designed from the ground up to be a sleek but sturdy companion to your monitor. To safely attach the Spectrum Stand:

1. Position the monitor face-down on a flat and stable surface.



IMPORTANT

To prevent the screen from getting scratched, defaced, or broken, cover your work surface with protective sheet foam or a non-abrasive cloth.



NOTE

If you have not yet unpacked Spectrum, you can safely attach the stand before removing the monitor from its box.

2. Slide the stand's base into the bottom of the stand arm, and then tighten the screw on the underside of the base.
3. Insert the top of the stand into the back of the monitor cabinet at an angle, then press down. The stand will click into place.



NOTE

The Dough Spectrum Stand (model ES07E31) is sold separately.

Removing the Spectrum Stand

1. Disconnect and remove all cables from the monitor.
2. Position the monitor face-down on a flat and stable surface.



IMPORTANT

To prevent the screen from getting scratched, defaced, or broken, cover your work surface with protective sheet foam or a non-abrasive cloth.

3. Slide up the quick-release button on the stand and lift the stand away from the monitor.



NOTE

The Dough Spectrum Stand (model ES07E31) is sold separately.

Attaching a VESA mount

Spectrum is compatible with most VESA mounting arms and mounts (sold separately). The VESA mount must support the 100×100mm VESA Mounting Standard and should be rated to hold at least 6.4kg of weight.



IMPORTANT

You might need additional tools such as a screwdriver (purchased separately) when you attach a mounting device.

1. Remove the four mounting screws from the back of the monitor.
2. Align the screw holes on your mounting device with the four VESA screw holes in the back of the monitor, then insert and tighten the four mounting screws through the mounting device and into the monitor.



IMPORTANT

These are generic instructions that may not apply to your mounting device. Always follow the mounting device manufacturer's instructions when mounting the monitor to a wall or swing arm.

Spectrum comes with four M4×10mm screws. To ensure that your monitor is mounted securely, you may need to use screws of a different length, which may or may not have been provided with your mounting device.

Connecting the power cable

- Connect the power cord to the AC adapter and plug the other end into a grounded AC outlet. Then connect the adapter to the DC power connector on the rear of the monitor.



CAUTION

To reduce the risk of electric shock or damage to the equipment:

Only use the power cord and AC adapter that came with your monitor. They're designed to work together and have been tested to ensure they're safe.

The plug on the power cord is designed to fit into a grounded outlet, which is a safer type of outlet. Make sure the outlet you're using is grounded before you plug in the monitor. Don't disable or remove the grounding pin or use a 2-pin adapter to circumvent it.

Check the ampere rating of the products you have plugged in, and make sure the total rating of everything you've plugged in doesn't exceed the rating of the outlet or power cord. Look at the power label on each device to find its ampere rating.

Be careful not to place anything on the power cords or cables. Arrange all cords and cables so that they can't be pulled, stepped on, or tripped over.

Always plug the power cord into an outlet that's easy to reach. When you need to unplug the monitor, hold the plug firmly and pull it out of the outlet. Don't pull the cord itself.

Connecting video cables

- Connect one end of an HDMI cable to one of the HDMI ports along the bottom of the monitor, and the other end to the HDMI port on the source device;
- Connect one end of a DisplayPort cable to the DisplayPort connector along the bottom of the monitor, and the other end to the DisplayPort connector on the source device; and/or
- Connect one end of a USB Type-C cable to USB Type-C port marked '1' along the bottom of the monitor, and the other end to the USB Type-C port on the source device.



CAUTION

When powering or charging your device via USB Type-C, DC power does not need to be connected. Do not connect two power sources (DC power in and USB Type-C) to the host device simultaneously.

Use only USB Type-C cables that are rated for up to 100W of power delivery. The use of inappropriate cables could represent a fire hazard. Charging at high power can cause high temperatures. Consult the documentation that came with your device about fire safety.



IMPORTANT

The host computer must be able to support the USB Power Delivery protocol over the USB Type-C connector to be charged or powered by Spectrum.

The host computer must be able to support DisplayPort Alternate Mode over the USB Type-C connector to provide Spectrum with an image signal.



NOTE

The monitor automatically determines which inputs have valid video signals. You can also select inputs manually using the on-screen display (OSD) menu.

With so many ports available, it isn't surprising that not everyone intends to use the same cable types or cable lengths. Our surveys show that because of this, more than half the cables we could have included in the box would have gone to waste. That's not good for the environment, and it's not good for your wallet, either. With this in mind, we ship our monitors without cables.

Connecting USB devices

The built-in USB hub

Spectrum has a built-in USB hub that allows you to connect multiple devices to your computer with a single cable.

The USB hub lets you plug in many devices at once, even if your computer doesn't have enough built-in ports. And instead of having cords all over your desk, you can gather them neatly in one spot. Only one USB cable is needed to connect your monitor to your computer.

Because the monitor also has a built-in USB switch, you can connect to up to two computers, and switch which of the two controls your USB devices, either manually or automatically based on the video port in use. You can learn more about setting up which port controls the built-in hub on page 32.

Connecting peripheral devices

The side of the monitor provides two USB Type-C and two USB Type-A downstream ports. You can use these to connect devices such as a mouse, keyboard, phone, external hard drive, solid-state drive, and practically anything that is USB-connected.

The monitor can also charge attached devices, at up to 15W through the USB Type-C ports, or up to 5W through the USB Type-A ports. You can control whether these devices continue charging while the monitor is turned off in the OSD menu. You can learn more about this setting on page 40.

- Connect a USB peripheral device or its cable to one of, or both the USB Type-A ports on the side of the monitor; and/or
- Connect a USB peripheral device or its cable to one of, or both the USB Type-C port on the side of the monitor.



IMPORTANT

Do not switch between USB upstream ports while a storage device connected to the downstream ports is in use, as this may cause data loss. For the same reason, it is not recommended to enable automatic USB hub host switching in the OSD menu if storage devices are attached to Spectrum's downstream ports.



NOTE

Spectrum's built-in USB hub supports speeds up to 10Gbps. The actual speeds may vary based on the connected peripherals and the capabilities of the USB port on the host device.

Connecting to the USB host device(s)

The bottom of the monitor provides two USB Type-C upstream ports. Either can be used to connect the built-in USB hub to a host device.

Connecting both USB Type C ports along the bottom to two separate host devices simultaneously allows you to select which of the connected host devices controls the USB hub from the on-screen display (OSD) menu. Only one host device can make use of the built-in USB hub at any time. You can learn more about USB hub settings on page 32.

- If you connected Spectrum to the video source device using USB Type-C port 1, this same cable can double as the upstream cable for the built-in USB hub; and/or
- If you connected Spectrum to the video source device using HDMI or DisplayPort, you will need to connect one end of a USB cable to either USB Type-C port along the bottom of the monitor, and the other end to a USB port on the host device.



NOTE

You must connect either one of, or both the USB Type-C upstream ports along the bottom of the monitor to the host device (computer, laptop, gaming console) to make use of USB ports of the built-in USB hub.

When connected by a single USB Type-C cable, Spectrum may not be able to simultaneously operate the built-in USB hub at its full speed and run the display at its maximum resolution, refresh rate, and color depth due to technical limitations. The bandwidth priority can be set in the OSD. You can learn more about setting your priority preferences on page 30.

Spectrum's built-in USB hub supports speeds up to 10Gbps. The actual speeds may vary based on the connected peripherals and the capabilities of the USB port on the host device.

When used only to enable the built-in USB hub, either of these ports can be connected using a cable with a USB Type-C connector on both ends, or a cable with a USB Type-C connector on one end and a USB Type-A connector on the other end. When USB Type-C port 1 is used to receive a video signal, audio signal, and/or to provide power, only a suitable cable with a USB Type-C connector on both ends will suffice.

Connecting an audio device

Spectrum has a built-in digital-to-analog converter (DAC) that sends audio signals from the video source device to the amplified 3.5mm audio jack connector on the rear of the monitor.

- Connect the 3.5mm audio jack plug to the audio port on the rear of the monitor to make use of your speakers, headphones, or other audio device.



CAUTION

To reduce the risk of personal injury, adjust the source device volume before using headphones, earbuds, or a headset. Gradually increase the volume until you can hear it clearly, comfortably and without distortion. Limit the amount of time you are subjected to high-volume sound.

Installing a security cable

You can secure the monitor to a fixed object with an optional security cable available from third parties.

- Connect the lock to the Kensington Security Slot on the rear of the monitor and use the key provided to attach and remove the lock.



IMPORTANT

If these instructions do not apply to your security cable, then follow the lock manufacturer's instructions when securing the monitor.

Setting up your workspace

...or setting up your battle station.

When setting up your workspace, whether it's for work or gaming, it's important to prioritize your safety and health. This means maintaining proper posture, health, and work habits, as well as setting up an ergonomic workspace with a properly positioned monitor.

Prolonged computer use can cause discomfort, headaches, eyestrain, or physical injury. If you experience numbness, aching, pain, stiffness, or any recurring or persistent discomfort or pain, take a break and consider consulting a medical professional.

Adjust your monitor

1. Adjust the monitor's height to a comfortable position for your individual workstation. The monitor's top bezel edge should not exceed a height that is parallel to your eye height.



NOTE

A monitor that is positioned low and reclined might be more comfortable for users with corrective lenses.

2. Tilt the monitor forward or backward to set it to a comfortable eye level.

3. Using the Spectrum Stand or select VESA monitor mounts, you can pivot the monitor from landscape to portrait orientation. This lets you adapt the layout of your screen to your applications.

When using the Spectrum Stand:

- a. Adjust the monitor to its highest position.
- b. Pivot the monitor 90° clockwise or counterclockwise from landscape to portrait orientation.



IMPORTANT

If the monitor is not in full height position when pivoting, the bottom corner of the monitor panel will come in contact with the base and potentially cause damage to the monitor or the stand.



NOTE

If you use the monitor in any orientation other than right-side-up, you can rotate the OSD menu and joystick controls to match the new orientation. You can learn more about adjusting the OSD on page 43.

Stay active

Reposition your monitor as you adjust your working posture throughout the workday. Don't stay in one fixed posture for too long, but avoid slouching or leaning, and get up to move around regularly.

To avoid discomfort and injury, it's important to take regular breaks while using the computer. Go outside, take a few deep breaths of fresh air, stretch, and exercise to take care of your body. This will not only help you maintain good health but can also boost your creativity, alertness, and reflexes, which can be beneficial whether you're aiming for a promotion or aiming for that elusive enemy sniper.



NOTE

The perfect working posture may require third-party accessories such as adjustable or ergonomic chairs, footrests, or specialized peripherals. All bodies are different, so try different things to find out what makes you most comfortable!

Watch your eyes

Take frequent breaks to rest your eyes. To avoid eye strain, it can help to look away from the monitor and focus on a distant point. Make sure your room is well-lit, and wear glasses or contact lenses if necessary.

Adjust the position of Spectrum to eliminate screen glare from windows or light sources.

Adjust the brightness and contrast settings on your monitor to enhance text and image clarity. You can learn more about adjusting the image on page 37.

Keep your Spectrum clean from dust and stains to maintain its readability and clarity. You can learn more about cleaning the screen on page 56.

Blue light

Visible light contains a range of wavelengths and energy. Blue light, which has the highest energy in the visible light spectrum, can potentially harm the eyes more than other visible light.

Sunlight is the main source of blue light, but excessive exposure to artificial blue light from computer screens can cause eye strain and discomfort, especially in dark environments.

The W-OLED panel used in Spectrum Black contains technologies that reduce the amount of blue light emitted during normal use. The panel is TÜV® Low Blue Light Content certified, UL Low Blue Light Display certified, and meets the requirements for the Eyesafe® Display Standard.

To further reduce the amount of blue light emitted from Spectrum, you can adjust the color temperature to warm colors or manually adjust the color balance. You can learn more about adjusting the color temperature on page 37.

Screen flicker

The constant on-off cycling of some monitors (also called 'flicker') may force your eyes to work harder to adjust to the changes in brightness.

Prolonged exposure to flickering screens may lead to loss of focus, fatigue, headaches, and blurred vision, especially in individuals who are sensitive to such visual stimuli.

The W-OLED panel used in Spectrum Black is based on technologies that do not produce flicker during normal use. The panel is TÜV® Flicker Free certified and UL Flicker-free certified.

Using the monitor

Turning on the monitor

1. Press the power button on the computer to turn it on.
2. Press the power button on the rear of the monitor to turn it on.

When the monitor is first turned on, the monitor automatically scans the signal inputs for an active input and uses that input for the screen.

The indicator light at the bottom of the monitor will light up white when the monitor is active.



NOTE

You can change the behavior of the indicator light or disable it entirely in the on-screen display (OSD) menu.

Turning off the monitor

1. Press the power button on the rear of the monitor to turn it off.



NOTE

If there is no video signal for a prolonged period, the monitor will enter standby mode. This means that the monitor is not turned off and will resume operation once a video signal is available again. By default, the indicator light will gradually dim and brighten in a breathing effect to indicate standby mode.

Cool features

One-cable solution

Typically, separate cables are needed to connect your monitor to your computer for video, audio, and USB data. Additionally, yet another cable is required to charge your laptop or other mobile device. With USB Type-C, you can do all of that with just one cable, simplifying the setup process. It's also a neat and straightforward way to declutter your desk from a tangle of cables.

You can attach a computer, notebook, or similar device to the monitor with a single USB Type-C cable, which then provides connectivity for high-speed data, audio, video, and up to 100W of power or charging.

- Connect one end of a USB Type-C cable to USB Type-C port 1 along the bottom of the monitor and the other end to the USB Type-C port on the computer, notebook, or other device.



CAUTION

When powering or charging your device via USB Type-C, DC power does not need to be connected. Do not connect two power sources (DC power in and USB Type-C) to the host device simultaneously.

Use only USB Type-C cables that are rated for up to 100W of power delivery. The use of inappropriate cables could represent a fire hazard. Charging at high power can cause high temperatures. Consult the documentation that came with your device about fire safety.



IMPORTANT

The host computer must be able to support the USB Power Delivery protocol over the USB Type-C connector to be charged or powered by Spectrum.

The host computer must be able to support DisplayPort Alternate Mode over the USB Type-C connector to provide Spectrum with an image signal.



NOTE

When connected by a single USB Type-C cable, Spectrum may not be able to simultaneously operate the built-in USB hub at its full speed and run the display at its maximum resolution, refresh rate, and color depth due to technical limitations. The bandwidth priority can be set in the OSD. You can learn more about setting your priority preferences on page 30.

Spectrum's built-in USB hub supports speeds up to 10Gbps. The actual speeds may vary based on the connected peripherals and the capabilities of the USB port on the host device.

KVM switch

With its wide selection of ports, Spectrum Black can connect to multiple devices at once. The built-in keyboard-video-mouse (KVM) switch feature lets you quickly change the display and attached peripherals such as a keyboard and mouse between two computers with the single press of a button.

Unlike most KVM switches, Spectrum Black offers multiple possible combinations of video- and USB upstream ports. Because of this, some preparation is required to let your monitor know which ports fit your use case:

1. Connect Spectrum's video ports to the two computers. You can learn more about connecting video source devices on page 16.
2. Connect Spectrum's upstream USB ports to the two computers. You can learn more about connecting USB host devices on page 18.
3. Connect your keyboard, mouse, and other USB peripherals you wish to switch. You can learn more about connecting USB peripherals on page 17.
4. Set the video input port connected to the first computer under 'Select video input source' in the Input/Output menu of the OSD. You can learn more about this setting on page 29.
5. Set the video input port connected to the second computer as the 'Secondary input source' in the Input/Output menu of the OSD. You can learn more about this setting on page 29.
6. Ensure that 'Host device override' is set to 'Off (select automatically)' in the USB hub menu of the OSD. You can learn more about this setting on page 32.
7. For each video input port you used to connect a computer, set the associated USB Type-C port as host device in the USB hub menu of the OSD. You can learn more about these settings on page 32.
8. Ensure that 'USB hub & power' is set to either 'Always' or 'When on or in standby' in the Performance menu of the OSD. You can learn more about this setting on page 41.

Once you have completed this set-up process once, pressing the KVM button will now switch the display and attached USB devices back and forth between the two computers.



IMPORTANT

Do not switch between USB upstream ports while a storage device connected to the downstream ports is in use, as this may cause data loss. For the same reason, it is not recommended to enable automatic USB hub host switching in the OSD menu if storage devices are attached to Spectrum's downstream ports.



NOTE

The effect described here is the default behavior. You can learn more about assigning a different quick action to the KVM button on page 43.

Quick actions

If the OSD menu, crosshair overlay, and frame rate counter overlay are not active, pressing the joystick in any direction will perform quick actions. This lets you quickly enable or disable features, or cycle through available options:

- Pressing down will cycle video input sources.
- Pressing up will cycle USB hub input sources.
- Pressing left will enable or disable the frame rate counter overlay.
- Pressing right will enable or disable the crosshair overlay.

Additionally, pressing the KVM button will switch between the primary and secondary video input.

The effects described here are the default behaviors. You can change these quick actions to best fit your own unique use case using the OSD menu. You can learn more about assigning different quick actions to each of the joystick directions and/or the KVM button on page 43.

Restore default settings

Keeping the power button depressed for 8 seconds restores all monitor settings to their factory default values.

Using the on-screen display

Use the on-screen display (OSD) menu to display information about your monitor, or to adjust the picture properties and monitor features based on your preferences.

Controlling the OSD menu

While the monitor is turned on, you can access the menu and make adjustments using the joystick on the rear of the monitor by reaching underneath the bottom bezel.

1. To access the OSD menu, depress the joystick to open the OSD.
2. Use the joystick to navigate, select, and adjust the menu choices.
 - Pressing up or down will change the current selection or adjust the current setting.
 - Pressing right will confirm the currently highlighted choice and proceed to the next submenu.
 - Pressing left will return to the previous menu level.



NOTE

Most settings will automatically be applied and stored as you cycle through the available options. Some settings do require you to confirm your selection by pressing right once more, before returning to the previous menu level or closing the OSD menu. These are generally settings that could cause compatibility issues or jarring changes in the display.

3. To close the OSD menu, depress the joystick. Alternatively, pressing the joystick left whilst in the main menu will close the menu. Finally, if no control inputs are given for a prolonged time, the OSD menu will close automatically.



NOTE

You can adjust the duration of this time-out in the 'OSD' submenu. You can learn more about adjusting the OSD time-out on page 42.

OSD components

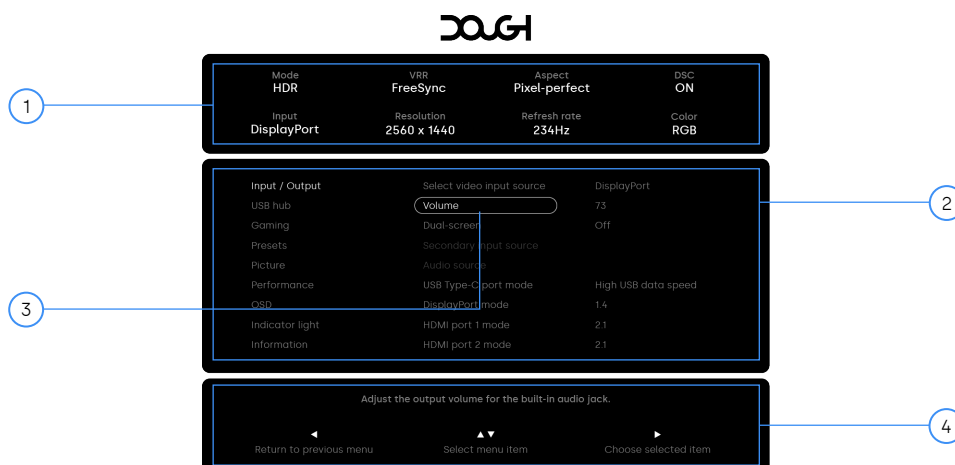

Live information display

The live information display (1) shows current information about your monitor and its signal source. Here you can quickly find information about your active inputs, resolution, refresh rate, and upscaling mode, as well as details about your image signal such as the use of HDR, variable refresh rate technology, chroma subsampling, and image signal compression.

When using dual-screen mode, the left half of the live information display describes the primary input, and the right half describes the secondary input.

OSD menu

The OSD menu (2) contains the settings that control your monitor's behavior. Here you can change the color qualities of the displayed image, as well as a slew of settings that allow you to fine-tune the features of the monitor.

The leftmost column contains the main menu, which contains categories of settings.

The middle column contains the settings of the current category.

The rightmost column displays the current values for each setting, or lets you choose your preferred value for the setting you are currently adjusting.

A white outline (3) marks the currently active menu item.

You can learn more about the various settings and their effects from page 29 onwards.

Help display

The help display (4) contains a short description for each setting and option in the OSD menu. It also indicates what effect the joystick controls will have at any given point in the menu.

Input/Output menu

Select video input source

Selects from which port the video source device is connected. When set to 'Select automatically', the monitor automatically switches to an active input, if the current input is not active.



NOTE

When set to 'Select automatically', the monitor may need more time to resume from sleep, as it will cycle through the available ports one by one, looking for a signal.

By default, you can quickly cycle through the various input sources by pressing the joystick down when the OSD menu is not active.

Dual-screen

Enables showing an image from two display input sources at once. When set to 'Split-screen mode', the two images are shown side-by-side (also known as picture-besides-picture (PbP) mode). When set to 'Picture-in-picture mode', the secondary image is shown as a small overlay in the corner of the primary image.

Secondary input source

Selects from which display input port the second image is shown in dual-screen mode. Pressing the KVM button will swap the primary and secondary input source by default.

Audio source

Selects from which of the two active input sources the audio is played in dual-screen mode. This setting is only available when 'Split-screen mode' is set to 'On'.

USB Type-C port 1 mode

Selects between maximum video signal bandwidth, or maximum USB hub data bandwidth for USB Type-C port 1.

	maximum USB hub bandwidth	maximum refresh rate at 1440p
High USB data speed	10Gbps	240Hz with DSC / 120Hz
High video signal bandwidth	480Mbps	240Hz



NOTE

The exact bandwidth usage is determined by a combination of resolution, refresh rate, color depth, and compression. Changing any one of these factors may alter the limits imposed on the others.

To reach 240Hz refresh rate when bandwidth priority is set to High USB data speed, your video source device must support display stream compression (DSC).

DisplayPort mode

Selects between the maximum performance of DisplayPort 1.4, or maximum compatibility with previous DisplayPort versions for the DisplayPort port and USB Type-C port 1.

HDMI port 1 mode

Selects between the maximum performance of HDMI 2.1, or maximum compatibility with previous HDMI versions for HDMI port 1.

HDMI port 2 mode

Selects between the maximum performance of HDMI 2.1, or maximum compatibility with previous HDMI versions for HDMI port 2.

Volume

Adjusts the output volume for the built-in audio jack.



CAUTION

To reduce the risk of personal injury, adjust the source device volume before using headphones, earbuds, or a headset.

Audio equalizer

Adjusts the balance between frequencies for the built-in audio jack.

	effect
Off	No changes are applied, things will sound as close as possible to the original source.
Pop	Very low frequencies are reduced, while mid- and high frequencies are boosted.
Dance	Low frequencies are strongly boosted, high frequencies are boosted.
Rock	Low frequencies are boosted, lower-mid frequencies are reduced, higher frequencies are slightly boosted.
Heavy	Low frequencies are boosted, mid frequencies are reduced, high frequencies are boosted.
Jazz	Low frequencies are boosted, higher frequencies are slightly boosted.
Classical	Mid- to high frequencies are slightly boosted.

USB hub menu

Host device override

Forces the monitor to ignore individual port settings and always use either USB Type- C port 1 or USB Type-C port 2 to connect the built-in USB hub to its upstream host device. When set to 'Off (select automatically)', the USB host device switches automatically based on the currently active video input port, following the individual port settings below.

 **IMPORTANT**

Do not switch between USB upstream ports while a storage device connected to the downstream ports is in use, as this may cause data loss. For the same reason, it is not recommended to enable automatic USB hub host switching in the OSD menu if storage devices are attached to Spectrum's downstream ports.

 **NOTE**

By default, you can quickly cycle through the various USB host device settings by pressing the joystick down when the OSD menu is not active.

USB Type-C port 1 host device

Selects which port the USB hub upstream host device is connected to when USB Type-C port 1 is the active video signal input port.

DisplayPort host device

Selects which port the USB hub upstream host device is connected to when the DisplayPort port is the active video signal input port.

HDMI port 1 host device

Selects which port the USB hub upstream host device is connected to when HDMI port 1 is the active video signal input port.

HDMI port 2 host device

Selects which port the USB hub upstream host device is connected to when HDMI port 2 is the active video signal input port.

Gaming menu

Frame counter

Enables or disables a live display of the current input frame rate. The counter can be shown in either large or small font.



NOTE

While the OSD menu is active, the frame rate counter cannot be displayed. If enabled, it will appear once the menu is closed.

By default, you can quickly toggle the frame rate counter on and off by pressing the joystick left when the OSD menu is not active.

As the monitor received no direct frame rate information from the graphics card, the frame rate displayed is based on the refresh rate. This means that it is only accurate when adaptive-sync is active.

At low frame rates, the graphics card may use a technique called low framerate compensation (LFC), duplicating frames to match the minimum refresh rate of Spectrum.

As Spectrum cannot differentiate between new frames and their duplicates the frame rate counter will in this case show the total number of frames generated by the graphics card (48). This may differ from the number of unique frames as displayed by some software-based frame rate counters.

Frame counter color

Selects the color of the frame counter.

Frame counter transparency

Selects the transparency of the frame counter.

Selects the position of the frame counter.

Crosshair

Enables or disables a targeting reticule overlay.



NOTE

While the OSD menu is active, the crosshair cannot be displayed. If enabled, it will appear once the menu is closed.

By default, you can quickly toggle the crosshair on and off by pressing the joystick right when the OSD menu is not active.

Crosshair color

Selects the color of the crosshair.

Crosshair transparency

Selects the transparency of the crosshair.

Crosshair style

Selects the style of the crosshair.

Dot	Cross	Eve
.	+	▽

Crosshair position

Adjusts the height at which the crosshair appears on the screen. (0 places the crosshair at the center of the display.)



NOTE

You can quickly adjust the position of the crosshair by pressing the joystick up or down when the crosshair overlay is active.

Black equalizer

Adjusts the brightness curve in darker areas of the screen to improve visibility.

Presets menu

Load factory defaults

Overwrites all monitor settings with those stored in the factory setting profile for the monitor, restoring default values. This does not overwrite the user presets.



NOTE

You can quickly load factory defaults by pressing and holding the Power button for eight seconds.

Load user preset 1

Overwrites all monitor settings with those stored in user-generated setting profile 1. This does not overwrite any user presets.

Load user preset 2

Overwrites all monitor settings with those stored in user-generated setting profile 2. This does not overwrite any user presets.

Load user preset 3

Overwrites all monitor settings with those stored in user-generated setting profile 3. This does not overwrite any user presets.

Save preset

Overwrites all monitor settings in the selected setting profile with the current values. This does not overwrite any other user presets.

Picture menu

Color space

Selects the color space in which the monitor operates. P3 is the native color space of the display panel and offers the widest range of colors. In sRGB mode or Adobe RGB mode, colors are adjusted to avoid overshoot in colors.

Brightness

Adjusts much light the monitor emits.



NOTE

High dynamic range (HDR) and black frame insertion (BFI) affect the displayed or perceived brightness. With this in mind, the monitor stores separate brightness values for when these features are either on or off.

Contrast

Adjusts the difference between light and dark areas of the monitor.

Sharpness

Adjusts how much the monitor emphasizes edges in the image.

Color temperature

Adjusts the colors of the monitor to match warm, cool, or neutral environmental light.

Allows for individual manual control of red, green, and blue light values to manually adjust the white balance of the image. This setting is only available when 'Color temperature' is set to 'User defined'.

Gamma

Adjusts the brightness curve between light and dark areas of the monitor in SDR content.



NOTE

High dynamic range (HDR) relies on a perceptual quantizer – electro-optical transfer function (PQ-EOTF) to determine exact brightness values, instead of using a gamma curve. Because of this, the Gamma control is not available when the monitor is in HDR mode.

EOTF

Adjusts the brightness curve between light and dark areas of the monitor in HDR content.



NOTE

Standard dynamic range (SDR) relies on a gamma curve to determine the transfer between light and dark shades instead of EOTF-PQ. Because of this, the EOTF control is not available when the monitor is in SDR mode.

Upscaling mode

Selects the method used for displaying content below native resolution.

	image upscaling behavior
Maintain aspect ratio	The image is scaled up as large as will fit on the display, without deforming it. This is a common default for TVs.
Pixel perfect	The image is scaled up by duplicating pixels at an integer ratio, as large as will fit on the display. This preserves the image quality of pixel art in retro games.
Stretch to fill	The image is scaled up as large as will fit on the display, even if that stretches the image.
1 : 1	The image is displayed exactly as per the input signal, even if that only uses a small portion of the screen.

Brightness control

Selects how brightness is determined based on algorithms and user settings. When set to 'Standard' or 'Tempered', the display will use the peak luminance control (PLC) algorithm (also known as 'automatic brightness limiter' or 'ABL') to provide the highest possible brightness, based on the total power consumption and brightness output of the display. The two modes differ as follows:

When set to 'Standard', the 'Brightness' control acts as a multiplier, increasing or reducing all brightness evenly. This is the way most users expect the Brightness control to function and is recommended for most multimedia use cases.

When set to 'Tempered', the 'Brightness' control acts as a cap, reducing the peak brightness of highlights before affecting more uniformly bright scenes. This may reduce brightness fluctuations in multimedia content, and tempers glaring bright spots on the screen.

When set to 'Uniform', the PLC algorithm is not used to push a higher peak brightness, and the monitor instead maintains its brightness level regardless of the total power consumption and brightness output of the display. This mode cannot provide the same spectacular highlights of the other modes but is more consistent and ideal for desktop use as there is less fluctuation in the brightness of individual display elements when switching or resizing apps.

Performance menu

Low-latency mode

Selects between the compatibility of a traditional frame buffer, or a line buffer to streamline input and output refresh rate.

Adaptive-Sync

Enables or disables support for variable refresh rates (VRR) through adaptive-sync technology. This feature enables AMD FreeSync, NVIDIA G-SYNC, VESA Adaptive-Sync, and HDMI-VRR features.

Black frame insertion

Introduces black frames in between image frames to reduce eye tracking blur. When set to 'Off', no black frame insertion is applied, providing the best possible brightness, and allowing the monitor to refresh at 240Hz. When set to 'On', one black frame is inserted for every image frame, greatly reducing motion blur at the cost of brightness. The maximum refresh rate in this mode is 120Hz.

Minimum strobe frequency

Sets a lower limit for black frame insertion (BFI) to avoid fatigue or eye strain from flickering at lower refresh rates. Below the set refresh rate, no black frames will be inserted, even if BFI is enabled.

Energy saving mode

Adjusts the behavior of the monitor to favor either maximum performance or power saving. When set to 'On', the monitor uses less power, but the brightness is reduced, it takes longer to start up, and the built-in USB hub may not always be available.

Faster start-up

Adjusts the behavior of the monitor to favor either start-up speed or power saving. When set to 'On', the monitor starts up and resumes from sleep faster. When set to 'Off', the monitor will use less power while off or in standby mode.

Unlock brightness

Adjusts the behavior of the monitor to favor either maximum brightness or power saving and longevity. When set to 'On', the display can reach up to 33% higher brightness in HDR mode and up to 50% higher brightness in SDR mode, but will use more power and may wear at an increased rate.

USB hub & power

Adjusts the behavior of the monitor to favor either availability of the built-in USB hub and charging functions, or power saving.

When set to 'Only when on', the monitor will use less power while off or in standby mode.

The table below shows how the different options affect the availability of the built-in USB hub and charging functions across different operating modes of the monitor.

	while the monitor is on	while in standby mode	while the monitor is off
Only when on	✓	✗	✗
When on or in standby	✓	✓	✗
Always	✓	✓	✓



NOTE

When set to 'Always', devices connected to the downstream USB ports of Spectrum will always be powered or charged, and available to the host device even when Spectrum is turned off. However, this still requires the monitor to be connected to AC power.

OSD menu

Language

Selects the language in which the OSD menu is displayed.

language	displayed as
English	English
Chinese	中文
Dutch	Nederlands
French	Français
German	Deutsch
Italian	Italiano
Japanese	日本語
Spanish	Español



NOTE

The 'Language' option in any language is followed by the word 'language' in English, and the name of each language is always displayed in its own language. This way, users who do not speak the currently selected language can always find the language setting to change it.

Position

Selects the location on the screen where the OSD menu is displayed.

Transparency

Adjusts the transparency of the OSD menu overlay.

Time-out

Adjusts the time delay since the last control input, before the OSD menu automatically closes. When set to '0', the menu is displayed indefinitely.

Rotation

Selects the orientation of the OSD on the screen and the corresponding orientation of the joystick controls, such that both are upright when the monitor is used in portrait mode.

Quick action: joystick up/down/left/right, KVM button

Selects the quick actions performed when pressing the joystick in the indicated direction, or when pressing the KVM button.

quick action	effect
Primary video input source	Cycles the primary video input source.
Secondary video input source	Cycles the secondary video input source.
KVM function	Swaps the primary and secondary video input.
USB hub host device	Cycles USB hub host device override modes.
Dual-screen mode	Cycles through single screen, split-screen, and picture-in-picture modes.
Frame counter	Toggles the frame counter overlay on and off.
Crosshair	Toggles the crosshair overlay on and off.
Black equalizer	Toggles the black equalizer on and off.
Black frame insertion	Toggles black frame insertion on and off.
Color space	Cycles through P3, sRGB, and Adobe RGB modes.
Brightness up/down	Increases/decreases the brightness.
Volume up/down	Increases/decreases the volume.
Load user preset 1/2/3	Loads the settings stored in user preset 1/2/3.

Indicator light menu

On Behavior

Selects the behavior of the indicator light when the monitor is on.

	indicator light behavior
Off	Off
Steady	Always on
Slow pulse	Very slowly breathes on and off
Fast pulse	Quickly breathes on and off
Slow blink	Slowly but repeatedly turns on and off
Fast blink	Quickly and repeatedly turns on and off

On brightness

Adjusts overall brightness of the indicator light when the monitor is on.

On color

Adjusts the red, green, or blue light value shown by the indicator light when the monitor is on.

Standby behavior

Selects the behavior of the indicator light when the monitor is in standby mode.

The options are described in detail in the description of the 'On behavior' setting earlier in this section.

Standby brightness

Adjusts overall brightness of the indicator light when the monitor is in standby mode.

Standby color

Adjusts the red, green, or blue light value shown by the indicator light when the monitor is in standby mode.

Maintenance menu



IMPORTANT

Spectrum Black comes with a suite of technologies that are designed to prevent or reduce the risk of image retention. Turning off the settings in the Maintenance menu will increase image quality or image consistency but will also increase the risk of image retention.

Screen shift

Selects if and how the screen shifts. When set to 'On', the monitor subtly shifts the entire image a few pixels over time at regular intervals. This helps to prevent image retention from the edges of windows and very small elements, such as fine lines in a game interface. The different settings shift the screen in different patterns.



NOTE

Earlier OLED panels using this health measure cut the edges off the displayed image where it shifted outside of the panel's display area. The display panel in Spectrum Black is actually made up of 2576 by 1456 pixels. This allows the screen to shift by up to 8 pixels in any direction, while still being able to display a full 2560x1440 QHD image!

Screen saver

Enables or disables the screen saver. When set to 'On', the monitor dims the display brightness when the display detects a static image displayed on the screen for five minutes and goes to sleep when the static image remains for an additional five minutes. This helps to prevent image retention from static images.

Logo extraction algorithm

Enables or disables the logo extraction algorithm (LEA). When set to 'On', the monitor detects static, on-screen elements such as logos or HUD elements in games and adjusts their luminance. This helps to prevent image retention from small static elements.

Local brightness control

Enables or disables Local Brightness Control (LBC). When set to 'On', the monitor reduces the brightness of specific areas of the screen that are displaying bright elements. This helps to prevent image retention from small bright elements.

Temporal Target Curve

Enables or disables temporal target curve (TTC). When set to 'On', the monitor keeps track of usage time, reducing the image brightness after prolonged use. This helps to slow down screen aging and helps to prevent image retention.

Convex Power Control

Enables or disables convex power control (CPC). When set to 'On', the monitor reduces luminance farther away from the center of the image. This reduces power draw and helps to prevent image retention.

Temporal peak luminance control

Enables or disables temporal peak luminance control (TPC). When set to 'On', the monitor detects stationary images that pose a high risk of retention and adjust the pixel luminance accordingly. This helps to prevent image retention from stationary, bright images.

Transistor wear compensation

Starts a calibration process that counteracts image retention that may occur after prolonged use due to wear in the display panel's transistor layer. Calibration will take a few minutes, during which the indicator light will slowly pulse in a blue color. The screen will be black and may display lines, artifacts, or flickers.



NOTE

This process runs automatically whenever you turn off the monitor after four cumulative hours of use. Though it is possible to start this process manually, we do not recommend it unless you are specifically experiencing image retention issues.

If the monitor has not been able to run automatically because it has not been turned off or has not entered stand-by mode for a long time, a notification may appear on the screen, prompting you to manually start the process.

OLED wear compensation

Starts a calibration process that counteracts image retention that may occur after prolonged use due to wear in the display's organic LEDs. Calibration will take a few minutes, during which the indicator light will slowly pulse in a magenta color. The screen will be black and may display lines, artifacts, or flickers.



IMPORTANT

Though the pixel cleaning process reverses existing image retention issues, doing so increases wear on the display panel. This is not a preventative measure, so you should not run this process manually unless you are already experiencing image retention.



NOTE

The process runs automatically whenever you turn off the monitor after many hours of use. Though it is possible to start this process manually, we do not recommend it unless you are specifically experiencing image retention issues.

Information menu

Model

Displays the monitor's model and model number.

Serial number

Displays the monitor's unique serial number.

Firmware version

Displays the monitor's current firmware version.

Total usage time

Displays the monitor's cumulative operating time.

Support and troubleshooting

Cable requirements

There are many different cables on the market, and not all of them will give you the best experience with your monitor. Here are some specifications and certifications you should keep in mind when purchasing a new cable for your monitor.

DisplayPort

DisplayPort is an audio/video interface that was first introduced in 2006 to provide a unified, easy to produce replacement for the variety of monitor connectors that were in use at the time. Though similar in capability to the more famous and TV-focused HDMI, DisplayPort has been designed with a focus on computer monitors. Today, DisplayPort is the best way to connect Spectrum to your desktop PC.

We recommend using a high-quality cable that is certified 'DP8K', has a DisplayPort connector on either end, and is no longer than 3m.

Goal	Requirement
Provide a video signal to the DisplayPort	<p>Certification: Use a cable that is certified 'DP8K'.</p> <p>Connectors: The cable can have a DisplayPort connector on both ends, or can have a DisplayPort connector on the monitor side and a USB Type-C connector on the computer side.</p> <p>Speeds: A cable that is certified 'DP8K' will provide support for all the benefits of DisplayPort 1.4. It will enable Spectrum's maximum resolution, refresh rate, and color depth, and support all its features.</p> <p>Cables of higher certification, such as 'DP40' or 'DP80', will also support all the benefits of DisplayPort 1.4.</p> <p>A cable that is not VESA-certified may only offer support for DisplayPort 1.2. It may not enable Spectrum's maximum resolution, refresh rate, and color depth, and it may not support features such as Display Stream Compression (DSC) and High Dynamic Range (HDR).</p> <p>Spectrum can operate its ports in DisplayPort 1.2 mode if your computer supports DisplayPort 1.4, but you must use an uncertified cable.</p>

HDMI

HDMI is an audio/video interface that was first introduced in 2002 to provide a convenient, digital connection between video devices and displays. It has quickly become a widespread standard and has evolved over time, with each new version introducing higher bandwidth support and a broader feature set. Today, HDMI is the best way to connect Spectrum to your consoles and other video devices.

We recommend using a high-quality cable that is certified 'Ultra High Speed HDMI Cable', has an HDMI connector on either end, and is no longer than 5m.

Goal	Requirement
Provide a video signal to one of the HDMI ports	<p>Certification: Use a cable that is certified 'Ultra High Speed HDMI Cable'.</p> <p>Connectors: The cable must have an HDMI connector on both ends.</p> <p>Speeds: A cable that is certified 'Ultra High Speed HDMI Cable' will provide support for all the benefits of HDMI 2.1. It will enable Spectrum's maximum resolution, refresh rate, and color depth, and support all its features.</p> <p>A cable with an older or no HDMI certification may not enable Spectrum's maximum resolution, refresh rate, and color depth, and it may not support features such as Display Stream Compression (DSC) and Variable Refresh Rate (VRR).</p>

USB Type-C

USB Type-C is a data connector that was first introduced in 2014 as a replacement for the existing Type-A and Type-B connectors and their variants. The connector is compact and reversible, making it convenient to use and suitable for small mobile devices. Though developed as the new connector for carrying the USB data protocol, USB Type-C is also capable of transmitting video data using the DisplayPort standard and it can transfer high amounts of power. It is important to note that even though the connector is technically capable of all these things, not every cable is made to the same standards, and USB Type-C cables can differ greatly in their capabilities.

We recommend a cable that is certified 'Certified USB' and 'DP8K', supports 'SuperSpeed USB 10Gbps' and 'USB-PD', contains an 'E-Mark' chip and is rated for up to 5A, has a USB Type-C connector on both ends, and is no longer than 1m.

Goal	Requirement
Provide a video signal to USB Type-C port 1	<p>Certification: Use a cable that is certified 'DP8K'.</p> <p>Connectors: The cable can have a USB Type-C connector on both ends or can have a USB Type-C connector on the monitor side and a DisplayPort connector on the computer side.</p> <p>Speeds: A cable that is certified 'DP8K' will provide support for all the benefits of DisplayPort 1.4. It will enable Spectrum's maximum resolution, refresh rate, and color depth, and support all its features.</p> <p>Cables of higher certification, such as 'DP40' or 'DP80', will also support all the benefits of DisplayPort 1.4.</p> <p>A cable that is not VESA-certified may only offer support for DisplayPort 1.2 and may not support features such as Display Stream Compression (DSC) and High Dynamic Range (HDR).</p> <p>Spectrum can operate its ports in DisplayPort 1.2 mode if your computer supports DisplayPort 1.4, but you must use an uncertified cable.</p>

Connect a computer to the built-in USB hub

Certification:

Use a cable that is certified 'Certified USB'.

Connectors:

The cable can have a USB Type-C connector on both ends or can have a USB Type-C connector on the monitor side and a USB Type-A connector on the computer side.

Speeds:

A cable that supports 'SuperSpeed USB 10Gbps' (also known as 'SuperSpeed+' or 'USB 3.1 Gen 2') will allow data transfer at the built-in hub's maximum speed of up to 10Gbps.

Cables of higher specification, such as 'USB 3.2 Gen 2x2', 'USB4', 'Thunderbolt 3', or 'Thunderbolt 4', will also allow a full speed connection to the built-in USB hub.

A cable that only supports 'SuperSpeed USB' (also known as 'USB 3.0' or 'USB 3.1 Gen 1') will only allow data transfer at up to 5Gbps.

A cable that only supports 'Hi-Speed USB' (also known as 'USB 2.0') will only allow data transfer at up to 480Mbps.

Provide power to a device connected to USB Type-C port 1

Specification:

Use a cable that supports 'USB Power Delivery' (USB-PD) version 2.0 or higher.

Connectors:

The cable must have a USB Type-C connector on both ends.

Speeds:

An 'E-Mark' (Electronically Marked Cable) chip is required to charge at Spectrum's full speed. This chip helps the monitor and your connected device determine their highest supported power transfer and contains important over-current and overload protections.

A cable that contains an 'E-Mark' chip and that is rated for up to 5 Amperes of current is required to charge at up to 100W.

A cable that does not contain an 'E-Mark' chip and/or is rated only for up to 3 Amperes of current, will only allow charging at up to 60W.

A cable that is rated for a lower current may offer limited or no charging capabilities.

Solving common problems

The following table lists possible problems, the possible cause of each problem, and the recommended solutions.

Problem	Possible cause	Solution
Screen is blank.	Power cord is disconnected.	Connect the monitor power cord.
	Monitor is off.	Press the monitor power button.
Screen is blank, or 'No signal' is displayed on the screen.	Monitor video cable is disconnected.	Connect the appropriate video cable between the computer and monitor. Be sure that the computer power is off while you connect the video cable.
	The monitor is set to the wrong input.	Press joystick down to switch video inputs, until a valid signal is found.
	System is in sleep mode.	Press any key on the keyboard or move the mouse to exit sleep mode.
Screen is blank, or 'Signal out of range' is displayed on screen.	System is powered off	Press the system's power button.
	Video resolution and/or refresh rate are set higher than what the monitor supports.	Change the settings to a supported setting.
Screen is blank, or video is flashing.	Video card is incompatible.	Replace the video card or connect the video cable to one of the computer's onboard video sources.
Image appears too dark.	Brightness setting is too low.	Open the OSD menu and select 'Brightness' in the 'Picture' menu to adjust the brightness scale as needed.

Updating firmware

Spectrum features user-upgradable firmware. Updating the firmware may resolve issues and may improve or add new features.

You can download the latest firmware updates from the support pages at <https://www.dough.tech>. Special instructions may be included, so keep an eye out for **instructions.pdf**.

Firmware is a specific class of software that provides low-level control for the device's specific hardware. Unlike device drivers which are stored on your computer's system drive, firmware is stored on the chips in the device itself. Though it rarely needs to be updated, firmware updates can improve system security, performance, or stability, and can in some cases even add new functionality.



IMPORTANT

Because firmware updates are written to non-volatile storage inside the monitor, there is a certain risk involved when installing them. Despite built-in failsafe- and recovery features, (a part of) Spectrum may not function properly if the update process is interrupted. Therefore, you should always make sure your monitor is connected to a reliable power source, and that you dedicate enough time to this process before you begin.

The documentation that comes with each firmware update lists the changes it enacts. We recommend that you only install firmware updates if you are experiencing issues with the affected features or intend to use the new features it adds.

Installing firmware updates is always done at your own risk!

Take careful note of your monitor's model number, and only use firmware files that are specifically developed for your exact model. Using firmware developed for a different model may cause (a part of) Spectrum to not function properly.

Always cross-check the model number of your monitor with the models listed in the firmware update's documentation! If you are uncertain about which firmware file is right for your monitor, please contact our support team at <https://www.dough.tech>.

Contacting support

If you cannot solve a problem using the troubleshooting tips in this section, you may need to contact our support team at <https://www.dough.tech>. Have the following information available when you contact Dough:

- Monitor model number
- Monitor serial number
- Purchase date on invoice
- Conditions under which the problem occurred
- Any error messages received
- Your hardware configuration
- Name and version of the software you are using

Locating the model and serial number

The serial number and product number are located on a label on the rear of the monitor. You may need these numbers when contacting Dough about your issue.

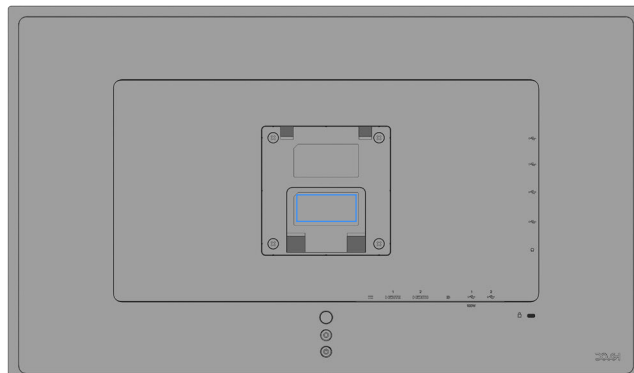

The model number is a seven-digit alphanumeric code starting with 'ES'.

The serial number is a thirteen-digit alphanumeric code starting with 'DS'.



NOTE

You may need to remove the Spectrum Stand or VESA mount to read the label.

Maintaining the monitor

Maintenance guidelines

To enhance the performance and extend the life of the monitor:

- When installing or removing the Spectrum Stand or a VESA mount, position the monitor face-down on a soft area to prevent it from getting scratched, defaced, or broken.
- Turn the monitor off when not in use. You can substantially increase the life expectancy of the monitor by using a screen saver program and turning off the monitor when not in use.



NOTE

Spectrum Black uses W-OLED display technology which provides deep blacks and advanced image quality, making it suitable for a wide variety of advanced image quality applications. This panel technology, however, is not suitable for applications that exhibit static, stationary, or fixed images for long periods of time without the use of screen savers. These types of applications may include camera surveillance, marketing logos, and templates that are displayed on the screen for a prolonged period.

Displaying the same static image or image elements on the screen for multiple consecutive hours may cause image retention damage that could look like stains or watermarks on the monitor's screen. Image retention (also called 'burn-in') is a condition that may occur on all OLED screens. To avoid image retention damage, either turn off the monitor when it is not in use or use the power management setting, if supported on your system, to turn off the monitor when the system is idle.

- Do not open the monitor cabinet or attempt to service this product yourself. Adjust only those controls that are covered in the operating instructions.
- If the monitor is not operating properly or has been dropped or damaged, contact an authorized Dough dealer, reseller, or service provider. This includes situations where:
 - the power cord or plug is damaged, cut or frayed;
 - liquid was spilled into the product;
 - the product was exposed to rain or water;
 - the product has been dropped or the housing has been damaged;
 - the product exhibits a distinct change in performance; or
 - the product does not operate normally after following the operating instructions.
- Disconnect the monitor by grasping the plug firmly and pulling it from the AC outlet. Never disconnect the monitor by pulling the cord.
- Slots and openings in the cabinet are provided for ventilation. These openings must not be blocked or covered. Never push objects of any kind into cabinet slots or other openings, or spill liquid of any kind onto or into the product.
- Keep the monitor in a well-ventilated area, away from excessive light, heat, or moisture.

Cleaning

1. Turn off the monitor and unplug the power cord from the AC outlet.
2. Dust the monitor by wiping the screen and the cabinet with a soft, clean antistatic cloth, for example microfiber.
3. When dealing with more than dust, use a cleaning solution specifically designed for LCD panels to dampen your cloth. Wipe the screen gently and in small circles avoiding pressure.



IMPORTANT

Never spray the cleaning solution directly on the device, as it may run behind the bezel and damage the electronics.

4. For more difficult cleaning situations, use a 50/50 mix of water and isopropyl alcohol to dampen your cloth. Wipe the screen gently and in small circles avoiding pressure.



IMPORTANT

Never spray the cleaning solution directly on the device, as it may run behind the bezel and damage the electronics.

Do not use cleaners that contain any petroleum-based materials such as benzene, thinner, or any volatile substance to clean the monitor screen or cabinet. These chemicals may damage the monitor and cause permanent discoloration.

5. Make sure the screen and housing are completely dry before using the monitor again.

Shipping

Keep the original packing box in a storage area. You may need it later if you wish to move or ship the monitor.

Disposal



Spectrum was built to bring you joy for years. Should the day come that it is time to discard it, do not throw this electronic device into the trash. To minimize pollution and ensure the protection of our global environment, please recycle. If everything still works, consider giving it a new life on the desk of a friend or family member. Thank you for doing your part to keep our planet safe!

Technical specifications

For the latest specifications or additional specifications on this product, visit the product pages at <https://www.dough.tech>.



NOTE

All specifications represent the typical specifications provided by Dough's component manufacturers; actual performance may vary either higher or lower.

Display

Size

monitor size	26.5" (diagonal)
display area	590×334mm
aspect ratio	16 : 9

Image quality

native resolution	2560×1440 pixels Quad-HD
pixel pitch	0.2292mm
pixel density	112ppi
sub-pixel layout	RWGB
brightness	150cd/m ² typical 450cd/m ² peak 1000cd/m ² peak (HDR, 3% of screen)
HDR	HDR10 Media Profile
displayable colors	1.07 billion
color gamut	98.5% DCI-P3 100% sRGB
color depth	10-bit
color accuracy	Individual factory calibration D65 white point, average $\Delta E < 1$ (typical)
contrast ratio	1 500 000 : 1 typical
viewing angles	178° horizontal 178° vertical
surface treatment	Low-haze anti-glare matte coating (model ES07E2F) Corning Gorilla Glass 3 with DXC anti-reflective treatment (model ES07E2D)

Speed

response time	0.03ms (gray-to-gray) typical
frequency range	40 – 240Hz
adaptive sync	48 – 240Hz VESA Adaptive-Sync certified NVIDIA G-SYNC Compatible certified AMD FreeSync Premium certified

Technology

panel technology	3 rd gen White organic light emitting diode (W-OLED) with Micro Lens Array (MLA)
backlight technology	N/A
backlight dimming	N/A
curved panel	No
touch-enabled	No
pen-enabled	No

Ports

Video input

HDMI (2x)	<p>HDMI 2.1a video input with 24Gbps of bandwidth, and support for:</p> <ul style="list-style-type: none"> - source-based tone mapping (SBTM); - display stream compression (DSC) 1.2; - enhanced display data channel (E-DDC); - HDR10 media profile; - variable refresh rate (VRR); - auto low latency mode (ALLM); - quick frame transport (QFT); - quick media switching (QMS); and - high-bandwidth digital content protection (HDCP) 2.2
DisplayPort (1x)	<p>DisplayPort 1.4 video input with support for:</p> <ul style="list-style-type: none"> - high bit rate 3 (HBR3) transmission mode; - display stream compression (DSC) 1.2; - enhanced display data channel (E-DDC); - HDR10 media profile; - variable refresh rate (VRR); and - high-bandwidth digital content protection (HDCP) 2.2
USB Type-C (1x)	<p>DisplayPort 1.4 video input with support for:</p> <ul style="list-style-type: none"> - high bit rate 3 (HBR3) transmission mode; - display stream compression (DSC) 1.2; - enhanced display data channel (E-DDC); - HDR10 media profile; - variable refresh rate (VRR); and - high-bandwidth digital content protection (HDCP) 2.2 <p>SuperSpeed USB 10Gbps (USB 3.1 Gen 2, up to 10Gbps) upstream connection to computer</p> <p>Power output up to 20V = 5A (100W) (USB PD 3.0)</p>

USB hub

USB Type-C (2x)	SuperSpeed USB 10Gbps (USB 3.1 Gen 2, up to 10Gbps) Power output up to 5V = 3A (15W)
USB Type-A (2x)	SuperSpeed USB 10Gbps (USB 3.1 Gen 2, up to 10Gbps) Power output up to 5V = 1A (5W)
USB Type-C upstream (1x)	SuperSpeed USB 10Gbps (USB 3.1 Gen 2, up to 10Gbps) upstream connection to computer (In addition to the USB Type-C port with video input)

Audio

3.5mm audio output (1x)	Analog audio output from video input source With pre-sets for neutral/scooped/bass-boosted equalizer profile.
-------------------------	--

Features

Black frame insertion (BFI) reduces eye-tracking motion blur and increases the clarity of objects that move quickly across the screen. (Available between 48 and 120Hz, at 50% duty cycle.)

The **Black equalizer** adjusts dark areas of the screen so you can always find your foes.

A **Crosshair overlay** assists your aim and gives a competitive advantage.

A **Frame counter overlay** shows you how well your system performs and helps pick the right settings for any game.

Pixel-perfect upscaling, using integer-ratio pixel duplication for low-resolution input signals, maintains the iconic look of pixel art and keeps retro games looking crisp.

The **USB Type-C port** lets you connect the monitor and its built-in USB hub to your mobile device with a single cable while also charging it at up to 100W.

The **KVM button** lets you quickly switch your monitor and a connected keyboard and mouse between two computers.

User-adjustable **Quick actions** give you quick access to the setting you use most.

Dual-screen lets you keep an eye on everything at once. Split-screen mode places the screens from two computers side-by-side, Picture-in-picture mode puts the image from a secondary computer in the corner.

User-upgradable firmware allows development to continue based on customer feedback, to tweak existing features and unlock new ones.

monitor mount support	Yes, VESA Mounting Interface Standard 100×100mm
security cable support	Yes, Kensington lock compatible
built-in speakers	No

Adjustment

Controls	1× Power button 1× KVM button 1× 5-Way joystick Controls are centered on the back of the monitor
status light	1× Power indicator light User-adjustable behavior and color (Default: solid white when on, pulsing white in standby)
OSD languages	English, Chinese, Dutch, French, German, Italian, Japanese, Spanish

Stand

material	Cast aluminum alloy
vertical tilt	7° down, 23° up
horizontal swivel	No
pivot / landscape rotation	90° left, 90° right
height adjust	122mm
removable	Yes, with quick-release button



NOTE

The Dough Spectrum Stand (ES07E31) is sold separately.

Size and weight

dimensions, monitor with stand (W×H×D)	604×580×131mm landscape, highest 604×452×131mm landscape, lowest 352×716×131mm portrait, highest 352×613×131mm portrait, lowest	
dimensions, monitor only (W×H×D)	604×352×34mm 679×457×133mm with box	
dimensions, stand only (W×H×D)	200×430×227mm 503×219×131mm with box	
weight, monitor with stand	7.6kg (model ES07E2F)	7.9kg (model ES07E2D)
weight, monitor only	5.6kg 9.8kg with box (model ES07E2F)	5.9kg 10.2kg with box (model ES07E2D)
weight, stand only	2.0kg 3.0kg with box	

Electrical and operating requirements

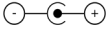
operating conditions	0 – 35°C
	10 – 80% RH
storage conditions	-10 – 60°C
	10 – 80% RH
power consumption	0.24W standby (Energy saving mode on) 2.14W standby (Energy saving mode off)
power input	19.5V $\overline{=}$ 11.8A 
power supply type	External power adapter
power supply input	110 – 240V \sim 3.5A 50 – 60Hz

Limited warranty

3 years limited warranty

2 years burn-in warranty



NOTE

For warranty details or instructions, please refer to the warranty policy available on <https://www.dough.tech>.

In the box

Dough Spectrum
Power adapter
Power cable
Quick start guide
Color calibration report