



Scan to Watch
Assembly Video
or go to
antennasdirect.com
/assembly-videos

Quick Start Assembly/Installation Instructions

CLEARSTREAM™ 4

Before beginning assembly, make sure all parts needed are present.

Coaxial cable sold separately.

READ BEFORE INSTALLATION:

Before permanently attaching the antenna to any surface, **TEST RECEPTION** in that area. Connect the antenna to the TV or converter box and run a full channel scan. If reception is not as desired, move the antenna and rescan for the available channels.

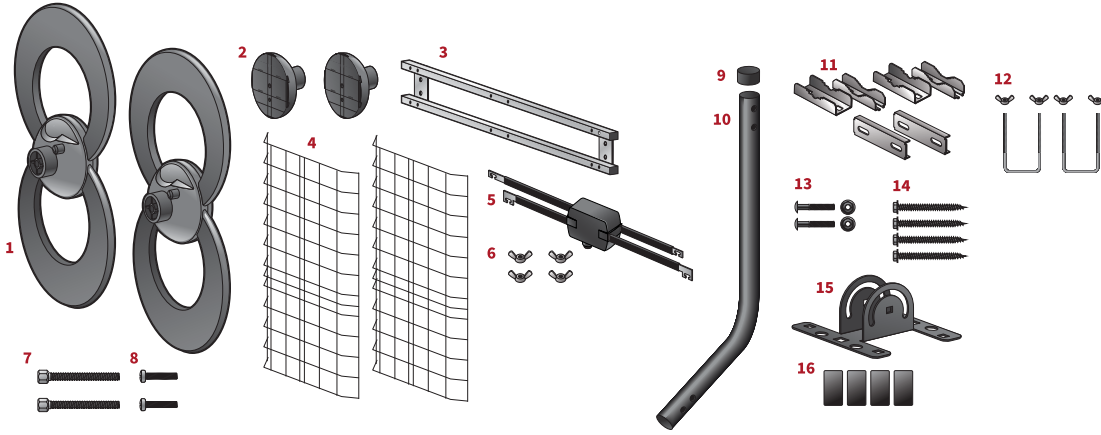

The ClearStream 4 comes with:

- 1) 2 - Antenna Elements
- 2) 2 - Antenna Bases
- 3) Cross Bar
- 4) 2 - Reflectors
- 5) Combiner Bars with 75 Ohm Transformer
- 6) 4 - Small Wing Nuts
- 7) 2 - 3 1/2" Bolts
- 8) 2 - 1 3/8" Bolts
- 9) Mast End Cap
- 10) Mast
- 11) 2 - Mast Clamps and Back Plates
- 12) 2 - U-Bolts and Large Wing Nuts
- 13) 2 - 40mm Hex Bolts and Nuts
- 14) 4 - 50mm Screws
- 15) Mast Base
- 16) 4 - Sealing Pads

SET UP THE ANTENNA:

Required: Coaxial Cable (sold separately), Adjustable Wrench, Power Drill, 3/16" Drill Bit, 8 and 10mm Ratcheting Drivers, and a #2 Phillips Screwdriver

Attach each Antenna Base (2) at the center of each Reflector (4), as shown, and "click" securely into place.

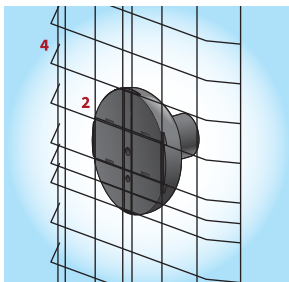

Connect one end of a coaxial cable (sold separately) to the Combiner Bars (5) and connect the other end to your TV or converter box.

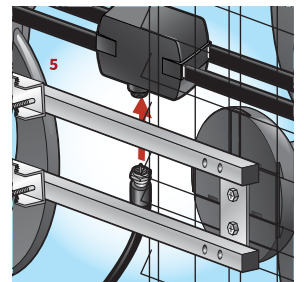

Next, follow the illustration to attach the Cross Bar (3) to the back of each Reflector using the 1 3/8" Bolts (8). Then, position the Antenna Elements (1) so the Antennas Direct logo on each one is in the same orientation, and attach them to the Antenna Bases using the 3 1/2" Bolts (7), as shown.

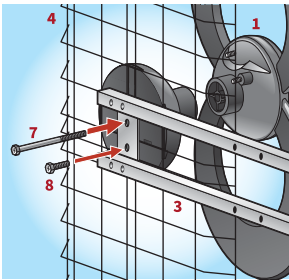

MAST INSTALLATION:

Attach the Mast (10) to the Mast Base (15) with the Hex Bolts and Nuts (13). Add the Mast End Cap (9) to the Mast (10).

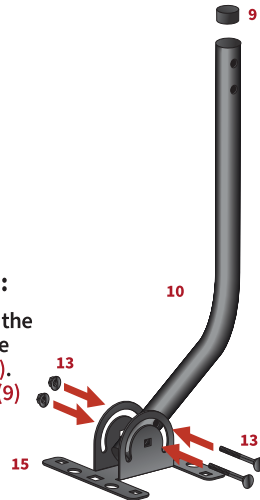

Warning! Keep Away from Power Lines.

IMPORTANT: CHECK THE RECEPTION IN THE LOCATION WHERE YOU INTEND TO INSTALL THE ANTENNA PRIOR TO ATTACHING THE MAST TO ANY SURFACE. SEE "SCANNING FOR CHANNELS" IN THE TROUBLESHOOTING GUIDE.

To add the mounting hardware, attach the Back Plates (11) and the U-Bolts (12) onto the Cross Bar (3) as shown.

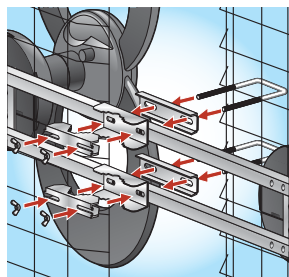
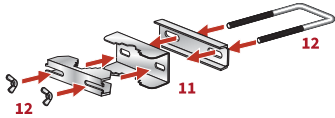

Mark the Mast Base (15) position on the desired surface and drill pilot holes, 1 1/2" deep, for each of the 50mm Screws (14).

Place the Sealing Pads (16) over the pilot holes, and the Mast Base (15) on top of the Sealing Pads.

Tighten the 50mm Screws (14) to secure the base to the surface.

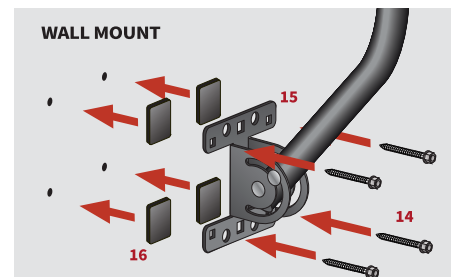

Secure loosely with the Large Wing Nuts (12), but do not tighten all the way.

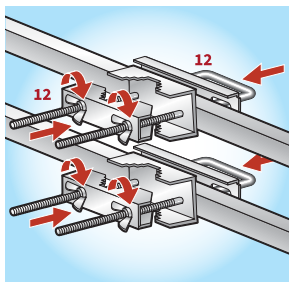

Before installing the antenna on the Mast (10), adjust the mast, so it is in a vertical position. You will need to adjust the antenna after it is mounted for the best reception.

Install the antenna on the Mast (10) by positioning the Mast Clamp (11) around the mast. Tighten the Wing Nuts (12) to secure the antenna to the mast.

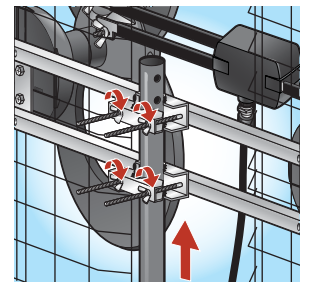

Attach the Combiner Bars (5) to each terminal on the back of each of the Antenna Elements (1). Secure loosely with the Small Wing Nuts (6), being careful not to over-tighten.

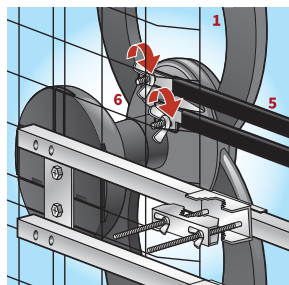

Now that you've installed your antenna, you are ready to scan for channels. See "Scanning for channels" in the troubleshooting guide.

Congratulations! You're watching HDTV for FREE!
Welcome to the Antennas Direct cord-cutting family.

TV RECEPTION CAN BE AFFECTED BY OBSTRUCTIONS OR DISTANCE BETWEEN YOUR HOME AND BROADCAST TOWERS.



Call us toll-free for technical assistance at **1-877-825-5572** or contact support@antennasdirect.com

FIND TV CHANNELS, AIM YOUR ANTENNA

antenna point

DOWNLOAD OUR FREE APP

TROUBLESHOOTING:

Problem: I'm not getting any signals at all.

Possible causes:

1. Analog-only televisions (manufactured before 2007) require a digital converter box. You MUST perform a channel scan on the converter box.
2. **SCANNING FOR CHANNELS:** A digital TV must be programmed in order to receive digital channels. Once your antenna is installed, you must complete a channel scan, even if you have done so before installing to find the best location for the antenna.
 - a) Your TV must be set to the proper input source. Press the "Input" (or "Source") button on your remote and make sure the input is set to TV.
 - b) Follow the instructions specific to the make and model of your television or converter box to set the signal type to "ANTENNA", "AIR", or "BROADCAST", **not "Cable"**.
 - c) Go to the main menu of your TV or converter box and complete a channel scan. This could be listed as "Auto Program", "Auto Tuning", or "Auto Channel Scan". Consult the owner's manual for your specific device and more precise guidelines. Be ready to experiment with various locations in your home. Remember to rescan for channels in every location.
3. Make sure the front of the antenna is facing the broadcast tower locations serving your area. Visit www.antennapoint.com for more information on broadcasters and tower locations serving your area, or download the **free Antenna Point app** to your Android/iOS smartphone or tablet.
4. **Outdoor Use:** You do not have a clear line of sight to your local broadcast towers. You might need to elevate and/or move your antenna. Make certain the antenna is not aimed into physical obstacles such as a roof, building, or trees. Remember to rescan for channels in every location.
5. You are outside the range of your antenna's capabilities. Depending upon the distance between your home and the local broadcast towers, you may need a longer range outdoor/attic antenna. Antennas Direct offers many models for this purpose.

6. You may have loose coaxial cable connections. Check ALL connections for a tight fit and check all outdoor connections for moisture or corrosion.
7. **Indoor Use:** Building materials such as brick, metal siding, radiant barrier, or stucco can greatly reduce the incoming signal. If in an attic, move the antenna outdoors. If outdoors, make certain the antenna is not aimed into physical obstacles, such as buildings, trees, or a hill. Remember to rescan every time you move your antenna.

Problem: I'm receiving every channel except for one.

Possible cause:

1. You may need to rescan the TV tuner or converter box. The channel you are not receiving may have its transmitter lower on the broadcast tower or on a different tower than the other transmitters and your line of sight is obstructed. Try elevating the antenna or moving it to another location. Repeat as needed.

Problem: I'm having signal breakups, but I'm only two miles from the broadcast tower.

Possible cause:

1. Your TV may be receiving interfering signals. A larger/stronger antenna will not necessarily solve this problem. Consider moving the antenna, making sure it is not placed near metal objects or other antennas. If this is not successful, your signal may be too strong and may require the use of an attenuator. Call our helpline or chat with us online at antennasdirect.com for an analysis of your area and installation. We may be able to offer simple solutions.

Before You Return, Call to Learn.



For Tower Locations:
antennapoint.com

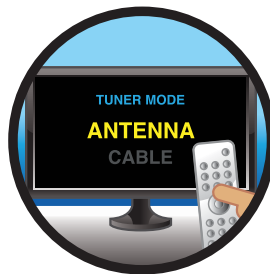

Input on Antenna Mode



Scanning is a Must.
When in Doubt, Rescan.

HELPLINE: 1-877-825-5572

MODEL # C4-CJM

Antennas Direct™ Inc. Antenna Lifetime Warranty

Antennas Direct™ Inc. warrants this product against any defects in materials or workmanship for as long as you own the product. No warranty claim will be honored unless, at the time the claim is made, you present proof of purchase from an authorized Antennas Direct™ Inc. dealer.

Antennas Direct™ Inc. will either repair or replace the defective product at no charge to you. This warranty covers parts but does not cover any costs incurred in the removal or reinstallation of the product. This limited warranty does not apply if the product is damaged or fails due to: misuse, improper installation, abuse, and modification of the product as originally manufactured by Antennas Direct.

Antennas Direct™ Inc. will not assume any liabilities for any other warranties expressed or implied by any other person. The foregoing shall be the sole and exclusive remedy of any person, whether in contract, tort, or otherwise, and Antennas Direct™ Inc. shall not be liable for incidental or consequential damage or commercial loss, or for any other loss or damage, as set forth above.

16388 Westwoods Business Park, Ellisville, MO 63021, USA

Limited 90-Day Warranty Mast

Antennas Direct™ Inc. warrants this product against any defects in materials or workmanship for ninety (90) days. No warranty claim will be honored unless, at the time the claim is made, you present proof of purchase from an authorized Antennas Direct™ Inc. dealer.

Antennas Direct™ Inc. will either repair or replace the defective product at no charge to you. This warranty covers parts but does not cover any costs incurred in the removal or reinstallation of the product. This limited warranty does not apply if the product is damaged or fails due to: misuse, improper installation, abuse, and modification of the product as originally manufactured by Antennas Direct.

Antennas Direct™ Inc. will not assume any liabilities for any other warranties expressed or implied by any other person. The foregoing shall be the sole and exclusive remedy of any person, whether in contract, tort, or otherwise, and Antennas Direct™ Inc. shall not be liable for incidental or consequential damage or commercial loss, or for any other loss or damage, as set forth above.

16388 Westwoods Business Park, Ellisville, MO 63021, USA

©Antennas Direct
Model # C4-CJM
01.2024

TV RECEPTION CAN BE AFFECTED BY OBSTRUCTIONS OR DISTANCE
BETWEEN YOUR HOME AND BROADCAST TOWERS.



Call us toll-free for technical assistance at **1-877-825-5572**
or contact support@antennasdirect.com

FIND TV CHANNELS, AIM YOUR ANTENNA

antenna point

DOWNLOAD OUR FREE APP