

## Introduction and Features

The AP4-GM61 provides 6-channel pre-amp outputs (front and rear, left and right, along with a center channel output and non fading output for subwoofer output) for use with aftermarket audio equipment. Using the full range, fixed level head unit output, in conjunction with MOST, the AP4-GM61 delivers variable 5v RMS pre-amp outputs with fading, balance, equalization, and level control capabilities. The module also retains all audio from other vehicle features such as factory navigation prompts, Bluetooth, OnStar, parking sensor chimes, safety alerts, reminders and infotainment. A data controlled remote amplifier turn on wire is also provided by the AP4-GM61. The module also provides a variable 2-channel fiber optic digital audio output (TOSLINK).

## Important Notes

1. This interface is only compatible in vehicles equipped with both Bose and the IO5 or IO6 8" radios. To verify the "IO" RPO code on your vehicle, check the glove compartment for a silver sticker with these codes. If this sticker is not present, you must scan the QR code on the GM label found in the driver's door jamb. The RPO codes will be listed in alphabetical order in either scenario.
2. The factory amplifier must remain in the vehicle, and connected, after the AmpPRO has been installed.
3. The remote output is rated at 2A of current. If more current is needed, an external relay must be used.
4. The remote output will be active whenever the vehicle's CAN-bus network is active (example: if the doors are unlocked from keyfob). Even if the radio is not on, the remote output may be active. The remote output will turn off once the vehicle's CAN-bus network goes to sleep. To verify, turn the ignition off, close all doors, and wait 5 minutes, then check if the amplifier is on **without opening the vehicle's doors, trunk or tailgate**.
5. Channel 5 is a variable volume, center channel output, and is derived from the in phase audio from the left and the right channels. The center channel output level can be adjusted using the AmpPRO PC application. Please refer to the Setup and Configuration section on page 3 for more details.
6. Channel 6 is a non-fading output (typically used for subwoofers). The output level of channel 6 can be adjusted at any time using the supplied level control knob.
7. When the non-fading level control knob is not connected to the AP4-GM61, the output level of channel 6 will always be at maximum.
8. The level control knob must be connected in order to manually adjust the chime volume and minimum volume settings.
9. The chime level in the radio's settings menu will not affect the chime level output from the AP4-GM61. Any chime audio provided by the AP4-GM61 requires the chime level adjustment to be done using the procedure provided in the Setup and Configuration section. If the factory amplifier is being used for the front or rear speakers, the chime level for the factory amplified speakers must be adjusted in the radio's settings menu. In some cases, it is necessary to adjust the chime level through the radio settings menu as well as through the AP4-GM61. For example: If the AP4-GM61 outputs are only being used on the front speakers, and the vehicle has rear parking sensors, adjustments would be made through the radio settings and through the AP4-GM61. In this instance the rear parking sensor chime level would be adjusted through the radio settings menu (since the reverse chimes play through the rear speakers), and any chimes coming through the front speakers would need to be adjusted via the AP4-GM61.
10. By default, the chime volume is set to 60 percent (adjustable in 5 percent increments from 0 to 100) and minimum volume is set to 0 db (adjustable in 2 db increments -20 db to +20 db). If you are happy with these levels in your particular application, then no further adjustment is necessary. Please refer to the Setup and Configuration section on page 3 for more details.
11. The factory radio's speed controlled volume and surround sound modes are not supported by the AP4 outputs.
12. When using the TOSLINK output, all chimes must be routed through the front output by setting DIP switch 1 on (down).
13. No adjustments can be made manually using the programming button, or the factory SWC when the module is connected to a PC.
14. If the aftermarket amplifier requires 2 channels of input from the non-fading, channel 6 output of the AP4-GM61, an RCA "Y" adapter is required.



### Wiring Connection Chart

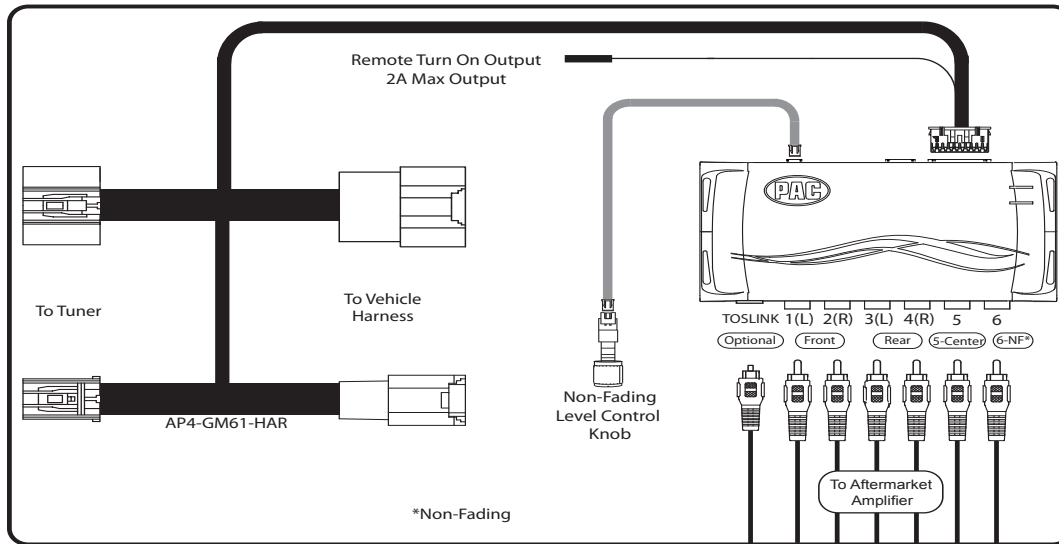

### Module Layout

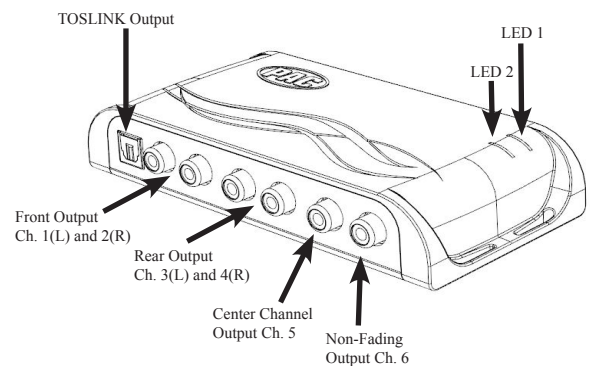
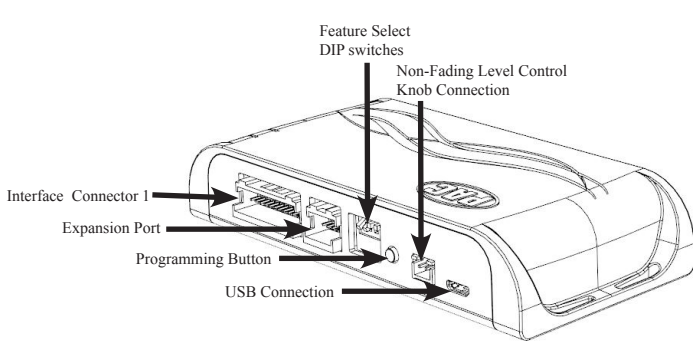

### Installation

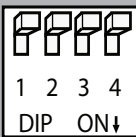

Set DIP switches to the ON position to activate the corresponding features. Set DIP switches to the OFF position for any features that are not desired.



Two Channel Mode	5v / 4v Preout	No Function	No Function
1	2	3	4

#### Be sure to perform the following steps with the ignition off:

1. Access the factory radio module (see location info in Figure 1, next page).
2. Disconnect the Gray 20-pin factory harness and the Gray 8-pin harness from the tuner module (Figure 2, next page).
3. Connect the AmpPRO harness to vehicle harness.
4. Connect the AmpPRO harness to factory tuner module.
5. Set any feature DIP switches that apply to your install.
  - a. DIP switch 1 is used for two channel mode. In this mode, both the TOSLINK and front RCA outputs (1 and 2) become non-fading outputs. All rear chimes will also be routed through these outputs in two channel mode.
  - b. Set DIP switch 2 on (down) to lower the RCA output voltage to 4v. Leave DIP switch 2 off (up) to keep the RCA output voltage at 5v. See the troubleshooting section on page 5 for more details.
6. Connect the AmpPRO harness to the module.
7. Connect the level control knob to the module and install in an accessible location.
8. Connect the signal cables and remote input from the aftermarket amplifier.
9. Shut all doors and lock the vehicle with the factory keyfob. Allow the vehicle 5 minutes to go to "sleep".
10. Proceed with setup and configuration.



### Installation (cont.)

Fig. 1

Vehicle	Radio Module Location
Full Size Trucks and SUVs, Colorado, Canyon	Behind Radio Display
CT6, Cruze	Back Passenger Sidewall of Trunk
Cadillac (others)	Above Passenger Kick Panel
Chevrolet Corvette	Passenger Footwell on Firewall
Camaro, Equinox, Impala, Malibu, Traverse	Above Passenger Kick Panel

Fig. 2

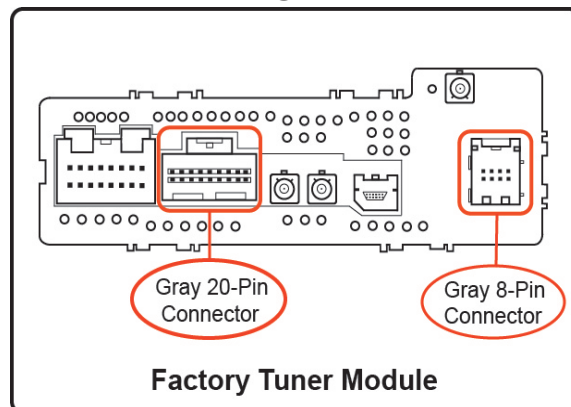

### Setup and Configuration

1. Turn the ignition on. Adjust the volume on the radio control panel. The red LED should flicker while the volume is changing.
2. Set the amp gain(s) to the desired level. We recommend using an oscilloscope and test tones to set the amp gain(s). Please refer to the MECP Advanced study guide (p. 360) if you are unfamiliar with this process.
3. Check volume, balance, fade and EQ settings.
4. If you would like to adjust the chime volume, center channel volume, or minimum volume, do so using one of the methods outlined on the next page. If you are happy with the default levels, no adjustments are necessary.

#### Manually Setting the Chime Volume (optional)

You can manually set the level of the factory chime using the programming button on the side of the interface, or the radio dash panel controls. If you would like to set the chime volume using the AmpPRO PC app please proceed to the AmpPRO PC app section.

**PLEASE NOTE: Knob must be connected to module for either of the following methods.**

#### Setting the chime volume using the programming button

1. Start with the level control knob turned all the way down (counter-clockwise).
2. Press the programming button on the side of the interface.
3. LED 1 will turn green and the chimes will begin continuously sounding.
4. Turn the level control knob clockwise until the desired chime level is reached.
5. You can now either press the programming button twice, or wait ten seconds to exit the settings.

#### Setting the chime volume using the radio dash panel controls

1. Start with the level control knob turned all the way down (counter-clockwise).
2. Press and hold the track down button on the radio dash panel for approximately ten seconds. **PLEASE NOTE:** The radio will respond to the track down commands during this process, this is normal and has no effect on the AP4 operation.
3. LED 1 will turn green and the chimes will begin continuously sounding.
4. Turn the level control knob clockwise until the desired chime level is reached.
5. You can now wait ten seconds to exit the settings.

#### Manually Setting the Minimum Volume (optional)

If the minimum volume of the radio (factory radio volume level 1) is too loud, you can manually set the level of the minimum volume using either the programming button on the side of the interface, or the radio dash panel controls. If you would like to set the minimum volume using the AmpPRO PC app, please proceed to the AmpPRO PC app section.

**PLEASE NOTE: Level control knob must be connected to module for either of the following methods.**

#### Setting the minimum volume using the programming button

1. Start with the level control knob turned all the way down (counter-clockwise).
2. Set the amp gains to the desired level.
3. Set the volume on the factory radio to 1.
4. Press the programming button on the side of the interface twice.
5. LED 1 will turn amber and the chimes will begin sounding every five seconds.
6. Turn the level control knob clockwise until the desired minimum volume level is reached.
7. You can now either press the programming button once, or wait ten seconds to exit the settings.

## Setup and Configuration (cont.)

### Setting the minimum volume using the factory dash panel controls

1. Start with the level control knob turned all the way down (counter-clockwise).
2. Set the amp gains to the desired level.
3. Set the volume on the factory radio to 1.
4. Press and hold the track up button on the radio dash panel controls for approximately ten seconds. **PLEASE NOTE:** The radio will respond to the track up commands during this process, this is normal and has no effect on the AP4 operation.
5. LED 1 will turn amber, and the chimes will begin sounding every five seconds.
6. Turn the level control knob clockwise until the desired minimum volume level is reached.
7. You can now wait ten seconds to exit the settings.

## AmpPRO PC App

### Use of the AmpPRO PC App allows you to do the following:

- Configure User Interface Options such as:
  - Minimum Volume Level
  - Center Channel Volume Percentage
  - Chime Volume Level
  - Enable / Disable AP4 Chimes
  - Enable / Disable factory EQ
  - Set Bass / Mid / Treble center frequencies and Q factor
- Update Product Firmware
- Read Firmware / Hardware Versions
- You can download the AmpPRO PC app at : <http://aampglobal.com/appdownloads>

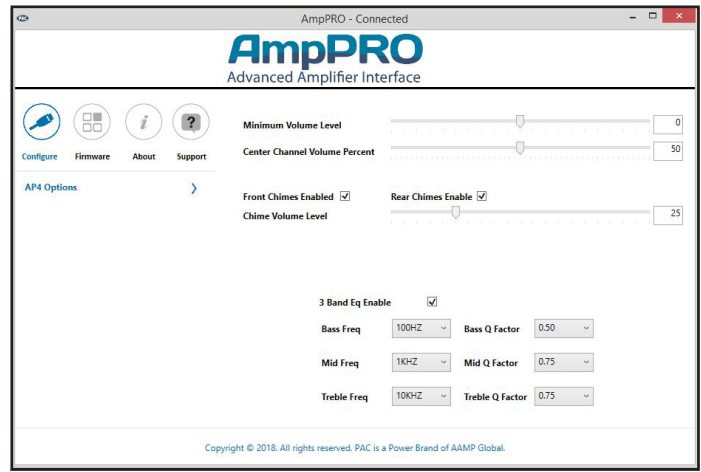

**PLEASE NOTE:** These settings can be adjusted with the module installed in the vehicle, or on the bench. However, it is recommended to make the adjustments with the module installed, and the factory radio on, so that the changes can be heard.

**Minimum Volume Level** - This allows you to set the minimum volume level of the factory radio (factory radio volume level 1).

**Center Channel Volume Level Percentage** - This allows you to set the gain of the center channel output.

**Chime Volume Level** - This allows you to set the volume of the AP4 chimes (e.g.: park sensors).

**Front / Rear Chimes Enabled** - This allows you to enable / disable AP4 chimes (e.g.: park sensors). This is used when mixing factory and aftermarket speakers.

**3 Band EQ Enabled** - This allows you to enable / disable the 3 band factory EQ.

**Bass / Mid / Treble Freq / Q Factor** - This allows you to set the center frequency that will be adjusted when setting the 3 band factory EQ, as well as the Q Factor for each frequency. The Q Factor determines how many of the adjacent frequencies will be affected when adjusting the selected frequency. The lower the Q Factor, the more frequencies will be affected. See below for available frequencies and Q Factors.

Available Frequencies and Q Factors					
Bass Frequency	60HZ	Mid Frequency	500HZ	Treble Frequency	7.5KHZ
	80HZ		1KHZ		10KHZ
	100HZ		1.5KHZ		12.5KHZ
	120HZ		2.5KHZ		15KHZ
Bass Q Factor	0.50	Mid Q Factor	0.75	Treble Q Factor	0.75
	1.00		1.00		1.25
	1.50		1.25		
	2.00		1.50		



### AmpPRO PC App (cont.)

#### Firmware Updates

The AmpPRO PC app will also allow you to update the interface with new firmware as it becomes available. Please visit [www.pac-audio.com](http://www.pac-audio.com) or contact our tech support department to see if there is a firmware update for your interface.

Connect the interface to your PC and select "Firmware", then "Update Firmware". Now select "Select File". Finally, browse to the place where you saved the file and select it. This will begin the updating process. Once finished, disconnect the interface from the PC and resume normal operation.

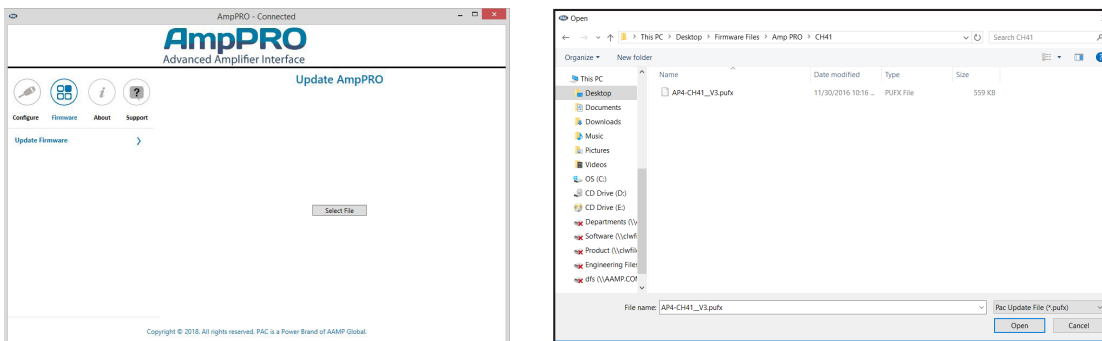

#### Restoring Factory Settings

You can restore the interface to factory default settings by pressing and holding the programming button on the side of the module until the status LEDs start blinking red. Once the LEDs start blinking red, release the button.

This reset will restore the following settings to their factory defaults:

- Center Channel volume level percentage
- Chime volume level
- Enable / Disable Factory Chimes
- Minimum volume level
- Enable / Disable factory EQ
- Factory EQ frequency
- Factory EQ Q factor

#### Troubleshooting

1. Hiss at high amp gain - Set feature DIP switch 2 to the on (down) position to lower the output voltage of the AP4 to 4v. If you still hear the hiss, lower your amp gains until the hiss is gone.
2. If you experience no audio after resetting the AP4-GM61, switch to a different audio source (AM, FM, SAT, USB, etc.) and test again.
3. Cannot hear OnStar or Nav Prompts - Use the factory volume controls while either of these are active to adjust the volume.
4. Cannot hear chimes - Set chime volume using process outlined in Setup and Configuration, or using the AmpPRO app. If you still do not hear chimes, be sure that you are using the remote output from the AP4 to turn on your aftermarket amplifier.
5. Low volume setting on radio is too loud - Set minimum volume using process outlined in Setup and Configuration, or using the AmpPRO PC app.
6. If for any reason the AmpPRO module becomes unresponsive, or will not power up with the key on, you can always reset the interface by turning the key to the ignition position, then pressing and holding the Power button on the factory radio for 12 seconds or by pressing and holding the reset button on the side of the AmpPRO module for 10 seconds (until the LEDs alternate flashing red).

LED Legend		
	Action / Color	During Normal Operation
LED 1	Solid Red	Module Active
	Solid Green	Chime Volume Adjustment Mode
	Solid Amber	Minimum Volume Adjustment Mode
	Rapid Blink Any Color	DSP Activity
LED2	Blink Amber	USB Connection Detected
Both LEDs	Alternate Blinking Red	Performing Memory Reset

